

Milliken's tree theorem and its applications: a computability-theoretic perspective

Paul-Elliot Anglès d'Auriac

Peter A. Cholak

Damir D. Dzhafarov

Benoît Monin

Ludovic Patey

Author address:

INSTITUT CAMILLE JORDAN, UNIVERSITÉ CLAUDE BERNARD LYON 1,
43 BOULEVARD DU 11 NOVEMBRE 1918, F-69622 VILLEURBANNE CEDEX,
FRANCE

Email address: `peada@free.fr`

DEPARTMENT OF MATHEMATICS, UNIVERSITY OF NOTRE DAME, 255
HURLEY BUILDING, NOTRE DAME, INDIANA 46556, U.S.A.

Email address: `cholak@nd.edu`

DEPARTMENT OF MATHEMATICS, UNIVERSITY OF CONNECTICUT, 341
MANSFIELD ROAD, STORRS, CONNECTICUT 06269, U.S.A.

Email address: `damir@math.uconn.edu`

LACL, DÉPARTEMENT D'INFORMATIQUE, FACULTÉ DES SCIENCES ET
TECHNOLOGIE, 61 AVENUE DU GÉNÉRAL DE GAULLE, 94010 CRÉTEIL
CEDEX

INSTITUT CAMILLE JORDAN, UNIVERSITÉ CLAUDE BERNARD LYON 1,
43 BOULEVARD DU 11 NOVEMBRE 1918, F-69622 VILLEURBANNE CEDEX,
FRANCE

Email address: `ludovic.patey@computability.fr`

Contents

| | |
|---|----|
| Acknowledgments | 1 |
| Chapter 1. Introduction | 3 |
| 1.1. Milliken’s tree theorem and Ramsey theory | 4 |
| 1.2. Computable combinatorics | 6 |
| 1.3. Plan of the manuscript | 9 |
| Chapter 2. Definitions | 11 |
| 2.1. Strings and subsets of \mathbb{N} | 11 |
| 2.2. Computability and reverse mathematics | 13 |
| 2.3. Second-order arithmetic and computable reducibility | 14 |
| 2.4. Trees and strong subtrees | 17 |
| 2.5. Forests and products of trees | 19 |
| 2.6. Statements of theorems | 22 |
| 2.7. Big Ramsey degrees and structures | 25 |
| Chapter 3. The Halpern-Laüchli theorem | 27 |
| 3.1. An effective proof of the Halpern-Laüchli theorem | 27 |
| 3.2. Product tree forcing | 30 |
| 3.3. Strong cone avoidance of MTT^1 | 33 |
| 3.4. Strong cone avoidance of the Halpern-Laüchli theorem | 37 |
| Chapter 4. Milliken’s tree theorem | 43 |
| 4.1. A proof of PMTT^n in ACA_0 | 43 |
| 4.2. Cone avoidance of PMTT^2 | 47 |
| 4.3. Proof of Theorem 4.13 | 52 |
| 4.4. Milliken’s tree theorem with more colors | 57 |
| Chapter 5. Devlin’s theorem | 63 |
| 5.1. A big Ramsey structure for dense linear orders | 63 |
| 5.2. A proof of Devlin’s theorem | 70 |
| 5.3. Lower bounds on Devlin’s theorem | 75 |
| 5.4. Above the big Ramsey number of Devlin’s theorem | 80 |
| 5.5. The Erdős Rado theorem | 81 |
| Chapter 6. The Rado graph theorem | 87 |
| 6.1. A big Ramsey structure for the Rado graph | 87 |
| 6.2. Joyce blossom graphs and an embedding theorem | 90 |

| | | |
|------------|---|-----|
| 6.3. | A proof of the Rado Graph theorem | 95 |
| 6.4. | Cone avoidance of the Rado Graph theorem for pairs | 98 |
| 6.5. | Lower bound on the Rado Graph theorem | 103 |
| Chapter 7. | A generalized tree theorem | 111 |
| 7.1. | Embedding types | 111 |
| 7.2. | Strong generalized CHM tree theorem | 112 |
| 7.3. | Avoiding types | 115 |
| 7.4. | Generalized CHM tree theorem | 120 |
| Chapter 8. | Open Questions | 123 |
| 8.1. | Milliken's tree theorem in the arithmetical hierarchy | 123 |
| 8.2. | Larger degrees and cone avoidance | 124 |
| 8.3. | Comparing the statements for pairs in reverse mathematics | 125 |
| | Bibliography | 129 |
| | Index | 133 |

Abstract

Milliken's tree theorem is a deep result in combinatorics that generalizes a vast number of other results in the subject, most notably Ramsey's theorem and its many variants and consequences. In this sense, Milliken's tree theorem is paradigmatic of structural Ramsey theory, which seeks to identify the common combinatorial and logical features of partition results in general. Its investigation in this area has consequently been extensive.

Motivated by a question of Dobrinen, we initiate the study of Milliken's tree theorem from the point of view of computability theory. The goal is to understand how close it is to being algorithmically solvable, and how computationally complex are the constructions needed to prove it. This kind of examination enjoys a long and rich history, and continues to be a highly active endeavor. Applied to combinatorial principles, particularly Ramsey's theorem, it constitutes one of the most fruitful research programs in computability theory as a whole. The challenge to studying Milliken's tree theorem using this framework is its unusually intricate proof, and more specifically, the proof of the Halpern-Laüchli theorem, which is a key ingredient.

Our advance here stems from a careful analysis of the Halpern-Laüchli theorem which shows that it can be carried out effectively (i.e., that it is computably true). We use this as the basis of a new inductive proof of Milliken's tree theorem that permits us to gauge its effectivity in turn. The key combinatorial tool we develop for the inductive step is a fast-growing computable function that can be used to obtain a finitary, or localized, version of Milliken's tree theorem. This enables us to build solutions to the full Milliken's tree theorem using effective forcing. The principal result of this is a full classification of the computable content of Milliken's tree theorem in terms of the jump hierarchy, stratified by the size of instance. As usual, this also translates into the parlance of reverse mathematics, yielding a complete understanding of the fragment of second-order arithmetic required to prove Milliken's tree theorem.

Received by the editor April 15, 2021.

2010 *Mathematics Subject Classification*. Primary 05D10, 03D80, 03E05; Secondary 05C55, 05D05, 03E75.

Key words and phrases. Milliken's tree theorem, Ramsey's theorem, partition theory, computable combinatorics, reverse mathematics, structural Ramsey theory.

We apply our analysis also to several well-known applications of Milliken's tree theorem, namely Devlin's theorem, a partition theorem for Rado graphs, and a generalized version of the so-called tree theorem of Chubb, Hirst, and McNicholl. These are all certain kinds of extensions of Ramsey's theorem for different structures, namely the rational numbers, the Rado graph, and perfect binary trees, respectively. We obtain a number of new results about how these principles relate to Milliken's tree theorem and to each other, in terms of both their computability-theoretic and combinatorial aspects. In particular, we establish new structural Ramsey-theoretic properties of the Rado graph theorem and the generalized Chubb-Hirst-McNicholl tree theorem using Zucker's notion of big Ramsey structure.

Acknowledgments

Cholak and Dzhafarov were partially supported by a Focused Research Group grant from the National Science Foundation of the United States, DMS-1854136 and DMS-1854355, respectively. Patey was partially supported by grant ANR “ACTC” #ANR-19-CE48-0012-01.

The authors express their gratitude and appreciation to the Institut Henri Poincaré in Paris for kindly hosting them in February of 2020, during which time this project was conceived, and much of it completed.

They also thank Natasha Dobrinen, Lu Liu, and Andy Zucker, for their valuable insights, suggestions, and clarifications during the preparation of this manuscript.

Finally, the authors wish to thank the anonymous referees for their thorough reading, and for critical comments that helped improve this work.

CHAPTER 1

Introduction

This monograph is part of the longstanding project of exploring connections between logic and combinatorics. Our focus is, more specifically, on studying the computable (or effective) content of combinatorial theorems. This has a long history, as we survey below. The interest stems from the realization that combinatorial notions tend to be computability-theoretically natural, and vice-versa. Traditionally, this has led to fine-grained analyses of different combinatorial constructions, often resulting in new, more computationally efficient proofs of various combinatorial results.

Over time, this work has made increasing use of powerful set-theoretic and combinatorial techniques, whose adaptation to the realm of computability theory has produced new insights into unsolved problems. Such will be the case for our investigation here of Milliken's tree theorem (named for its author, and originally proved in [30]; cf. also [31]). This is a deep result whose significance in Ramsey theory and related areas has made it the objective of much attention in combinatorics and set theory. This makes all the more surprising its near complete absence from the computability-theoretic literature. To our knowledge, the only published mentions are by Carlson and Simpson [2, Section 3] and Chubb, Hirst, and McNicholl [8]. The authors of the former paper introduce the so-called dual Ramsey's theorem, and give as a consequence a new proof of the Halpern-Laüchli theorem, an important result for understanding Milliken's tree theorem that we investigate at length also here. The latter paper focuses on what is ultimately a kind of weak or degenerate form of Milliken's tree theorem, which has garnered a great deal of interest in its own right. See Chapter 7, where we give a full account of the theorem of Chubb, Hirst, and McNicholl and how it relates to Milliken's in the context of our work here. (We add that during the writing of this manuscript, we learned of a concurrent project of Chong, Li, Liu, and Yang in progress, whose focus is the Chubb, Hirst, and McNicholl theorem but which also obtains results about Milliken's tree theorem proper. Specifically, the authors obtain by independent means our Corollary 4.7 below.)

The problem of determining the computable content of Milliken's tree theorem was proposed by Dobrinen [10]. A related question, about the so-called Rado graph theorem, was asked also in Dobrinen, Laflamme, and Sauer [11, Question 6.3]. We give a complete analysis here, using the tools of computability theory and reverse mathematics. As we will show, Milliken's

tree theorem turns out to be surprisingly rich and intricate in this respect, reflecting its centrality among other partition theorems, including Ramsey's theorem and its many variants.

1.1. Milliken's tree theorem and Ramsey theory

Ramsey theory is a vast area of combinatorics, broadly interested in results about when some sort of regularity is unavoidable when a large given structure is partitioned into a small number of pieces. (Here "large" is typically taken to mean a particular finite or infinite cardinality, and "small" is understood relative to this cardinality.) Canonical examples include, of course, the finite and infinite Ramsey's theorems, both due to F. P. Ramsey [35], which we recall. Let \mathbb{N} denote the set of natural numbers, $\{0, 1, 2, \dots\}$, and given a set $X \subseteq \mathbb{N}$ and integer $n \geq 1$, let $[X]^n = \{(x_0, \dots, x_{n-1}) \in X^n : x_0 < \dots < x_{n-1}\}$. We identify each $k \in \mathbb{N}$ with the set of its predecessors, $\{0, 1, \dots, k-1\}$.

THEOREM 1.1 (Finite Ramsey's theorem). *For all $n, k, \geq 1$ and $m_1, \dots, m_{k-1} \in \mathbb{N}$ there is a number $M \in \mathbb{N}$ such that for every $f : [M]^n \rightarrow k$ there is an $i < k$ and a set $H \subseteq M$ of size m_i such that $f(\vec{x}) = i$ for all $\vec{x} \in [H]^n$.*

THEOREM 1.2 (Infinite Ramsey's theorem). *For all $n, k \geq 1$ and every $f : [\mathbb{N}]^n \rightarrow k$ there is an $i < k$ and an infinite set $H \subseteq \mathbb{N}$ such that $f(\vec{x}) = i$ for all $\vec{x} \in [X]^n$.*

The sets H above are called *homogeneous sets* for the coloring f . There are also versions of Ramsey's theorem for colorings of uncountable sets, but we will restrict our attention here to the countable setting.

In broad strokes, Ramsey's theorem(s) can be seen as saying that in any configuration of integers, however complicated or random, some amount of order is necessary. Understanding this order, and how it arises, is naturally captivating, and its study has resulted in important advances across mathematics, from combinatorics to logic to number theory. These include, for example, the celebrated Szemerédi's theorem (cf. [45, 46]), the various proofs of which over the years, and the myriad mathematical ideas used in them, led to it be called the "Rosetta stone" of mathematics by Tao [47]. We will explore a number of other examples in this monograph. For a general introduction to Ramsey theory, we refer the reader to the book of Graham, Rothschild, and Spencer [18]. For more background on the kind of combinatorics most relevant to us here, we refer to Todorćević [48].

The main subject of the present monograph, Milliken's tree theorem, is a strong generalization of the infinite Ramsey's theorem. We state it here in a restricted form in order to be able to begin discussing it. The full statement requires more nuanced definitions that we delay until the next chapter. For now, we recall that $2^{<\omega}$ denotes the set of all finite binary strings, i.e., finite sequences of 0s and 1s. For $\sigma \in 2^{<\omega}$, we write $|\sigma|$ for the length of σ , i.e., the number of bits occurring in σ , and we let 2^n and $2^{<n}$ denote the sets

of $\sigma \in 2^{<\omega}$ with $|\sigma| = n$ and $|\sigma| < n$, respectively. For $\sigma, \tau \in 2^{<\omega}$ we write $\sigma \preceq \tau$ to mean that σ is an initial segment (not necessarily proper) of τ , and $\sigma \prec \tau$ to mean $\sigma \preceq \tau$ and $\sigma \neq \tau$. We also write $\sigma \wedge \tau$ for the longest common initial segment of σ and τ . The crucial notion in the statement of Milliken's tree theorem is the following: $S \subseteq 2^{<\omega}$ is a *strong subtree* of $2^{<\omega}$ if S is closed under \wedge , and (S, \preceq) is isomorphic, as a structure, to either $(2^{<\omega}, \preceq)$ or $(2^{<n}, \preceq)$ for some n , via a map that preserves whether or not a pair of nodes has the same length. Thus, for instance, $\{01, 0101, 0110\}$ is a strong subtree of $2^{<\omega}$, whereas $\{01, 0100, 0101\}$ and $\{01, 0101, 0111\}$ are not, even though all three sets, under \preceq , are isomorphic to $(2^{<n}, \preceq)$. (See Figure 1.1.)

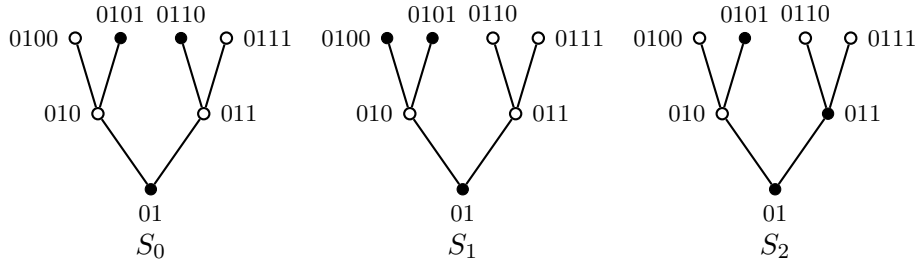

FIGURE 1.1. Three subsets, S_0 , S_1 , and S_2 , of $2^{<\omega}$. Solid circles indicate strings in the set, hollow circles strings not in the set. Only S_0 is a strong subtree of $2^{<\omega}$.

Given $T \subseteq 2^{<\omega}$, let $\mathcal{S}_\omega(T)$ denote the set of strong subtrees of $2^{<\omega}$ that are contained in T and isomorphic to $(2^{<\omega}, \preceq)$. For $n \geq 1$, let $\mathcal{S}_n(T)$ denote the set of strong subtrees of $2^{<\omega}$ that are contained in T and isomorphic to $(2^{<n}, \preceq)$.

THEOREM 1.3 (Milliken's tree theorem for $2^{<\omega}$). *For all $n, k \geq 1$ and all $f : \mathcal{S}_n(2^{<\omega}) \rightarrow k$ there exists $i < k$ and a $T \in \mathcal{S}_\omega(2^{<\omega})$ such that $f(S) = i$ for all $S \in \mathcal{S}_n(T)$.*

To begin, note that the infinite Ramsey's theorem is a straightforward consequence of (even this version of) Milliken's tree theorem. Indeed, given a coloring $f : [\mathbb{N}]^n \rightarrow k$, we define $g : \mathcal{S}_n(2^{<\omega}) \rightarrow k$ as follows. For each $S \in \mathcal{S}_n(2^{<\omega})$, let $\vec{x}_S = \{|\sigma| : \sigma \in S\}$, which is a set of size n and so can be viewed as an element of $[\mathbb{N}]^n$. Let $g(S) = f(\vec{x}_S)$. Now if $T \in \mathcal{S}_\omega(2^{<\omega})$ is as given by Milliken's tree theorem for this g , then $H = \{|\sigma| : \sigma \in T\}$ is easily seen to be an infinite homogeneous set for f .

Indeed, it is well-known that Milliken's tree theorem implies a great many partition theorems, including a number that are significantly more difficult to prove than Ramsey's. We will look at several of these theorems in this manuscript, and show that their implications from Milliken's tree theorem can be made constructive in the sense of computability theory and

reverse mathematics, which we discuss below. Much of this will rely on carefully identifying and examining features common between strong subtrees of $2^{<\omega}$ and the combinatorial structures underlying these other principles, using a combination of ideas that have previously been successfully employed in structural Ramsey theory, along with techniques newly developed here.

We refer the reader to Todorćević [48, Chapter 6] for an in-depth discussion of Milliken’s tree theorem, and a careful development of a proof. As with Ramsey’s theorem, the proof has an inductive form based on the exponent, n , of the colorings being considered. Thus, we prove it first for finite colorings of $\mathcal{S}_1(2^{<\omega})$, and then assuming it holds for finite colorings of $\mathcal{S}_n(2^{<\omega})$, we prove it for finite colorings of $\mathcal{S}_{n+1}(2^{<\omega})$. The base case, $n = 1$, is actually not difficult to prove directly (though it is less trivial than the $n = 1$ case of Ramsey’s theorem, i.e., the infinitary pigeonhole principle). However, unlike in standard proofs of Ramsey’s theorem, where the inductive step uses just the $n = 1$ case to increase the exponent, in the case of Milliken’s tree theorem a stronger result is needed. This is the so-called Halpern-Laüchli theorem, due originally to Halpern and Laüchli [19], and independently Laver (unpublished) and Pincus [33] (see [34] for more on the history).

Given $d \geq 1$ and $T_0, \dots, T_{d-1} \subseteq 2^{<\omega}$, let $\mathcal{S}_\alpha(T_0, \dots, T_{d-1})$ for $\alpha \in \mathbb{N} \cup \{\omega\}$ be the collection of all tuples (S_0, \dots, S_{d-1}) such that for each $i < d$ we have $S_i \in \mathcal{S}_\alpha(T_i)$, and for all $i, j < d$ and all $\sigma \in S_i$ and $\tau \in S_j$, we have that σ has the same number of initial segments in S_i as τ does in S_j if and only if $|\sigma| = |\tau|$.

THEOREM 1.4 (Halpern-Laüchli theorem for $2^{<\omega}$). *For all $d, k \geq 1$ and all $f : \bigcup_{n \in \mathbb{N}} (2^n)^d \rightarrow k$ there exists $i < k$ and*

$$(T_0, \dots, T_{d-1}) \in \mathcal{S}_\omega(2^{<\omega}, \dots, 2^{<\omega})$$

such that $f(\vec{\sigma}) = i$ for all $\vec{\sigma} = (\sigma_0, \dots, \sigma_{d-1}) \in T_0 \times \dots \times T_{d-1}$ with $|\sigma_0| = \dots = |\sigma_{d-1}|$.

Prima facie, this theorem appears as a kind of parallelized version of Milliken’s tree theorem for colorings of $\mathcal{S}_1(2^{<\omega})$, and one may expect it to be not much more complicated to prove. In fact, this is misleading, and the Halpern-Laüchli theorem largely encompasses the entire combinatorial core of (the full) Milliken’s tree theorem. We will analyze the Halpern-Laüchli theorem in detail in this monograph, and use it in a careful way to give a more effective proof of Milliken’s tree theorem.

1.2. Computable combinatorics

The principal theme of modern computability theory is *relative* computability: a set $X \subseteq \mathbb{N}$ is *computable from* (or *Turing reducible to*) a set Y , written $X \leq_T Y$, if there is an algorithm to decide which numbers belong to X using information about which numbers belong to Y . If $X \leq_T Y$ and $Y \leq_T X$ we write $X \equiv_T Y$. This notion, along with a precise formalization

of the concept of an algorithm, was a seminal achievement of Turing in the 1930s. Sets can be classified in numerous ways, such as in terms of their structural properties or by their syntactic descriptions.

As a rule, all such properties can be *relativized*, leading to increasingly larger classes of sets. For example, the *halting problem relative to X* , denoted X' and also called the (*Turing*) *jump of X* , refers to the set of $e \in \mathbb{N}$ such that the e th algorithm in some fixed listing, with access to information about X , halts on input e . For every X we have that $X \leq_T X'$ but $X' \not\leq_T X$, which yields in particular a canonical example of a non-computable set. The complexity of a set of natural numbers in computability theory (or by extension, of any object that can be naturally represented or encoded by such a set) is a measure of “how far” it is from being computable, according to various hierarchies of classes of sets obtained in this fashion. For general background in computability theory, we refer the reader to Soare [42] and to Downey and Hirschfeldt [12].

Computability theory lends itself to analyzing a vast collection of problems that are sometimes called *instance-solution problems*. This refers to theorems having the form

$$(1.1) \quad \forall A [P(A) \implies \exists B Q(A, B)],$$

where P and Q are some sort of properties of A , and of A and B , respectively. One can regard such a theorem as the problem, “Given an A such that $P(A)$ holds, find a B such that $Q(A, B)$ holds”. In this context, we call such A the *instances* of the problem (or theorem), and all such B the *solutions* to A . This is a natural way of thinking about theorems of this shape. For example, the instances of Ramsey’s theorem are all finite colorings of $[\omega]^n$ for some n , and the solutions to any such coloring are its infinite homogeneous sets.

One way to gauge the complexity of an instance-solution problem is by studying the relationship between the complexity of instances and solutions, when these can be presented as subsets of \mathbb{N} , as will be the case in all the examples we consider in this manuscript. From this perspective, a problem that is *computably true*, i.e., one each of whose instances has at least one solution computable in that instance, is trivial from the algorithmic standpoint. By contrast, a problem that has an instance all of whose solutions compute the jump of that instance, is strictly harder, being, in a certain sense, at least as difficult as “solving the halting problem”. In general, the further apart the instances and solutions are in this sense, the more algorithmically complex it is. We can thus directly compare different problems in terms of their complexity, yielding a notion of algorithmic or computability-theoretic strength. For a thorough introduction to this kind of analysis, which is generally called *computable mathematics*, see the book of Hirschfeldt [20].

A complementary approach is provided by the foundational program of *reverse mathematics*, developed by Friedman and Simpson in the late 1970s. The setting here is second-order arithmetic, a formal system strong enough

to express countable analogues of most results of classical mathematics. Its axioms include the usual ordered semi-ring axioms for the natural numbers, together with *comprehension axioms* asserting that the set of all numbers x satisfying a given formula (property) exists. By restricting to only certain kinds of formulas we get various *subsystems* of second-order arithmetic, the most basic of which is called RCA_0 and roughly corresponds to computable mathematics. The traditional approach in the subject has been to compare a given theorem with several benchmark subsystems (WKL_0 , ACA_0 , ATR_0) extending RCA_0 , corresponding to increasing levels of non-constructibility. Isolating the weakest such system that the theorem can be proved in, and the strongest that can in turn be proved from it over the base system RCA_0 , yields a measure of its proof-theoretic strength. There is a fruitful and well-understood interplay between reverse mathematics and computability theory, with ideas and results from one often leading to results in the other (see Shore [38]). This has been made even more pronounced in recent years by the introduction of various Weihrauch-style reducibilities to the subject, which have come to be viewed largely as an extension and refinement of the traditional program of reverse mathematics. Computable reducibility, in particular, which is a non-uniform analogue of Weihrauch reducibility originally introduced in [13], will figure in a number of our results here.

The standard reference on reverse mathematics is Simpson [41]. Weihrauch reducibility was introduced by Weihrauch [50] in the 1990s, and has since been widely deployed in computable analysis and other fields; for a recent survey, see Brattka, Gherardi, and Pauly [1].

Of course, instance-solution problems are ubiquitous across mathematics, but problems from combinatorics have figured especially prominently in the above frameworks for many decades. The classification and differentiation of combinatorial theorems according to their computability-theoretic and proof-theoretic strength is nowadays called *computable combinatorics*. Perhaps the earliest result here is the following one from the late 1960s, stating that Ramsey's theorem for pairs is not computably true.

THEOREM 1.5 (Specker [43]). *There is a computable $f : [\omega]^2 \rightarrow 2$ with no computable infinite homogeneous set.*

(In the parlance of reverse mathematics, this shows that Ramsey's theorem for colorings of pairs is not provable in the base theory, RCA_0 .) This result was greatly extended in the seminal 1972 paper of Jockusch [23], which set off an industry of research on Ramsey's theorem in computability theory that is still highly active today.

The computability-theoretic perspective offers insights that are not readily discernible in combinatorics alone. In the case of Ramsey's theorem, a well-known example is provided by the following pair of results.

THEOREM 1.6 (Jockusch [23], Theorem 5.7). *For each $n \geq 3$, there is a computable $f : [\omega]^n \rightarrow 2$ each of whose infinite homogeneous sets computes $\emptyset^{(n-2)}$ (and in particular \emptyset').*

THEOREM 1.7 (Seetapun; see [37]). *Every computable $f : [\omega]^2 \rightarrow 2$ has an infinite homogeneous set that does not compute \emptyset' .*

Thus, there is a direct computational distinction between Ramsey's theorem for colorings of pairs and Ramsey's theorem for colorings triples and larger tuples. (Formalizing these results in RCA_0 yields that Ramsey's theorem for colorings of triples implies the system ACA_0 over RCA_0 , whereas Ramsey's theorem for colorings of pairs does not.)

Such threshold phenomenon, where an increase in a parameter changes a theorem from not being able to encode specific non-computable information to being able to do so, are observed quite widely. For example, as was shown by Dzhafarov and Patey [15], this is the case for the aforementioned theorem introduced by Chubb, Hirst, and McNicholl [8]. And more recently, Chong et al. [5] obtained similar results for a theorem of Erdős and Rado about colorings of pairs of rationals. We will likewise establish threshold phenomena for Milliken's tree theorem and the various consequences of it we consider.

Another computability-theoretic feature that will feature prominently in our work is *cone avoidance*. In the subject, a *cone* refers to a set of subsets of ω closed upward under \leq_T . As a case in point, the set of all sets X that compute \emptyset' is a cone, and Seetapun's theorem (Theorem 1.7 above) can be seen as saying that every computable instance of Ramsey's theorem for colorings of pairs has a solution that lies outside (or avoids) this cone. The emphasis here is on the restriction to *computable instances*, however; indeed, it is easy to see that there is a (necessarily non-computable) $f : [\omega]^2 \rightarrow 2$, each of whose infinite homogeneous sets *does* compute \emptyset' . By contrast, some instance-solution problems enjoy a stronger property called *strong cone avoidance*, whereby *every* instance (computable or not) has at least one solution that avoids the cone of sets that compute \emptyset' . This is the case, for example, for the infinitary pigeonhole principle, as shown by Dzhafarov and Jockusch [14, Lemma 3.2]. We shall investigate both cone avoidance and strong cone avoidance for versions of Milliken's tree theorem, and in particular, for the Halpern-Laüchli theorem. It is worth noting, too, that while every computably true problem obviously possesses cone avoidance, not every such problem satisfies strong cone avoidance. (For example, consider the identity problem, whose instances are all $X \subseteq \omega$, and the only solution of X is X itself.)

1.3. Plan of the manuscript

The manuscript is organized as follows. In Chapter 2, we give further background and definitions to allow us to state the full versions of Milliken's tree theorem and the Halpern-Laüchli theorem. In Chapter 3, we proceed to the computability-theoretic analysis of the Halpern-Laüchli theorem, as a bootstrap to understanding the computational content of Milliken's tree theorem. In particular, we prove that the Halpern-Laüchli theorem is

computably true (Theorem 3.4) and admits strong cone avoidance (Theorem 3.21). Then, in Chapter 4, we analyse a product version of Milliken's tree theorem. We prove that the statement is equivalent to ACA_0 for strong subtrees of height at least 3 (Corollary 4.7), and that its restriction to colorings of strong subtrees of height 2 admits cone avoidance (Theorem 4.15). Lastly, we prove that a weakening to the product version of Milliken's tree theorem for height 3, for which the solutions have now at most 2 colors instead of 1, admits cone avoidance (Theorem 4.28). We then study three applications of Milliken's tree theorem for pairs, namely: Devlin's theorem concerning colorings of tuples of rationals (Chapter 5); a theorem about colorings of finite subgraphs of the Rado graph (Chapter 6); and a generalization of the combinatorial theorem of Chubb, Hirst, and McNicholl discussed above (Chapter 7). Finally, in Chapter 8, we state some questions that our investigation leaves open.

CHAPTER 2

Definitions

The aim of this chapter is to review key concepts to make the rest of this monograph more easily accessible to computability theorists, set theorists, and combinatorialists. Our terminology and notation will for the most part be standard, following, e.g., [12] and [48]. Where there is less uniformity in the literature, we highlight our particular usage in this chapter and, as the need arises, in the sequel. In Section 2.1 we set out our notation for finite strings, operations on them, and spaces of subsets of \mathbb{N} , which are largely common across these fields. Sections 2.2 and 2.3 provide an overview of some technical notions from computability theory and reverse mathematics. In Sections 2.4 and 2.5, we review combinatorial definitions relevant to stating Milliken's tree theorem and some of its corollaries, which we then present in Section 2.6. Finally, in Section 2.7, we review some terminology from structural Ramsey theory that helps give a common framing for these principles.

We begin with some basics. We use \sqcup to denote disjoint union. For every set X , we denote by $\mathcal{P}(X)$ the power set of X . And given a function f on X , we let $f \upharpoonright Y$ denote the restriction of f to $Y \subseteq X$.

Throughout, we use (\dots) to denote (ordered) tuples of objects, and given a function f defined on a tuple (a_0, \dots, a_n) we write $f(a_0, \dots, a_n)$ in place of $f((a_0, \dots, a_n))$. In the computability-theoretic setting, we do not make a notational distinction for coded tuples (of numbers, subsets of \mathbb{N} , or combinations thereof). Thus, we also let (\dots) denote a fixed computable bijection from finite ordered tuples of natural numbers to \mathbb{N} , e.g., as in [42, p. xxxii]. For $X_0, \dots, X_{n-1} \subseteq \mathbb{N}$ we will sometimes use (X_0, \dots, X_{n-1}) as an alternative notation for the join, $X_0 \oplus \dots \oplus X_{n-1} = \{(x, i) : x \in X_i, i < n\} \subseteq \mathbb{N}$. In the case that some X_i is a singleton, say containing x , we will write simply $(X_0, \dots, x, \dots, X_{n-1})$ in place of $(X_0, \dots, \{x\}, \dots, X_{n-1})$.

Given a countable collection of sets $\{X_0, X_1, \dots\}$ indexed by the natural numbers, we write $\bigcup_n X_n$ for $\bigcup_{n \in \mathbb{N}} X_n$.

2.1. Strings and subsets of \mathbb{N}

The following definition is included for completeness.

DEFINITION 2.1.

- (1) $\omega^{<\omega}$ denotes the set of all finite strings of natural numbers, i.e., functions $\sigma : n \rightarrow \omega$ for some $n \in \mathbb{N}$.

- (2) $2^{<\omega}$ denotes the subset of $\omega^{<\omega}$ of binary ($\{0,1\}$ -valued) strings.
- (3) The *length* of $\sigma \in \omega^{<\omega}$ is the cardinality of its domain, and is denoted by $|\sigma|$.
- (4) The unique string of length 0 is denoted by ϵ .
- (5) For $n \in \mathbb{N}$, ω^n and $\omega^{<n}$ denote the sets of $\sigma \in \omega^{<\omega}$ with $|\sigma| = n$ and $|\sigma| < n$, respectively.
- (6) For $n \in \mathbb{N}$, 2^n and $2^{<n}$ denote the sets of $\sigma \in 2^{<\omega}$ with $|\sigma| = n$ and $|\sigma| < n$, respectively.

As is customary, we will alternate between the function and sequence point of view for elements of $\omega^{<\omega}$. For $\sigma \in \omega^{<\omega}$ and $i < |\sigma|$ we will thus speak of $\sigma(i)$ and the $(i+1)$ st element of σ (or $(i+1)$ st *bit*, if $\sigma \in 2^{<\omega}$) interchangeably, or as convenient. We will sometimes specify σ explicitly as $(\sigma(0)\sigma(1)\cdots\sigma(|\sigma|-1))$.

DEFINITION 2.2. Fix $\sigma, \tau \in \omega^{<\omega}$.

- (1) σ is an *initial segment* of τ , and τ is an *extension* of σ , written $\sigma \preceq \tau$, if $\sigma = \tau \upharpoonright n$ for some $n \leq |\tau|$.
- (2) σ is a *proper initial segment* of σ , and τ is a *proper extension* of σ , written $\sigma \prec \tau$, if $\sigma = \tau \upharpoonright n$ for some $n < |\tau|$, i.e., if $\sigma \preceq \tau$ and $\sigma \neq \tau$.
- (3) σ and τ are *incompatible*, written $\sigma \perp \tau$, if $\sigma \not\preceq \tau$ and $\tau \not\preceq \sigma$.
- (4) The *meet* of σ and τ , denoted by $\sigma \wedge \tau$, is the longest common initial segment of σ and τ , i.e., $\sigma \wedge \tau = \sigma \upharpoonright n$ for the longest n such that $\sigma \upharpoonright n = \tau \upharpoonright n$.
- (5) The *concatenation* of σ by τ is the string $\sigma\tau : |\sigma| + |\tau| \rightarrow \omega$ with $\sigma\tau(i) = \sigma(i)$ for all $i < |\sigma|$ and $\sigma\tau(i) = \tau(i - |\sigma|)$ for all $|\sigma| \leq i < |\sigma| + |\tau|$.

So, for the sake of completeness, notice that if $\sigma \wedge \tau = \sigma$ then $\sigma \preceq \tau$. Observe too that ϵ is an initial segment of every σ , and $\epsilon\sigma = \sigma\epsilon = \sigma$. Finally, if $\sigma, \tau \in 2^{<\omega}$ then so is $\sigma\tau$.

DEFINITION 2.3.

- (1) ω^ω denotes the set of all functions $X : \mathbb{N} \rightarrow \mathbb{N}$, and 2^ω the set of all $\{0,1\}$ -valued such functions.
- (2) $\sigma \in \omega^{<\omega}$ is an *initial segment* of $X \in \omega^\omega$, and X is an *extension* of σ , written $\sigma \prec X$, if $\sigma(i) = X(i)$ for all $i < |\sigma|$.

When convenient, we identify sets with their characteristic functions, which gives us the usual equivalence between elements of 2^ω and elements of $\mathcal{P}(\mathbb{N})$. For this reason, we use $X \upharpoonright \ell$ for $\ell \in \mathbb{N}$, which denotes the restriction of the characteristic function of X to ℓ , also as shorthand for $\{x \in X : x < \ell\}$.

The sets ω^ω and 2^ω each have natural topologies defined on them, respectively generated by basic open sets of the form

$$[\sigma] = \{X \in \omega^\omega : \sigma \prec X\}.$$

for $\sigma \in \omega^{<\omega}$, and

$$[\sigma] = \{X \in 2^\omega : \sigma \prec X\}.$$

for $\sigma \in 2^{<\omega}$. This turns ω^ω into a Baire space and 2^ω into a Cantor space. For our purposes here, the main relevant topological consideration will be that 2^ω is compact.

2.2. Computability and reverse mathematics

Everywhere, we adopt the Church-Turing thesis, and therefore forego any specifics of our model of computation. We take as fixed some listing Φ_0, Φ_1, \dots of all partial computable functions such that from each e we can computably determine the program of Φ_e , and conversely, from each program we can computably find an e such that Φ_e executes this program. Nominally, we think of e as being a code for the sequence of steps in the program under a Gödel coding (see, e.g., [42], Definitions 1.5.1 and 1.7.2).

Recall that a set $W \subseteq \mathbb{N}$ is *computably enumerable* (c.e.) if it is the domain of some partial computable function, i.e., the set of inputs on which a given Turing program halts in finite time. We denote the domain of Φ_e by W_e .

DEFINITION 2.4. A *Turing functional* is a c.e. set Γ of pairs $(\sigma, \tau) \in 2^{<\omega} \times 2^{<\omega}$ (coded as numbers) such that if (σ, τ) and (σ', τ') belong to Γ and $\sigma \preceq \sigma'$ then $\tau \preceq \tau'$. In this case, for every set $X \subseteq \mathbb{N}$, we also define the following.

- (1) $\Gamma^X = \bigcup \{\tau \in 2^{<\omega} : (\exists \sigma \prec X)[(\sigma, \tau) \in \Gamma]\}$.
- (2) We write $\Gamma^X(x) = y$ or $\Gamma^X(x) \downarrow = y$ if $\tau(x) = y$ for some (and hence all) $(\sigma, \tau) \in X$ with $\sigma \prec X$ and $|\tau| > x$; we write $\Gamma^X(x) \downarrow$ if $\Gamma^X(x) = y$ for some y , and otherwise we write $\Gamma^X(x) \uparrow$.
- (3) Γ^X is *total* if $\Gamma^X(x) \downarrow$ for all $x \in \mathbb{N}$.

Note that if Γ^X is total then it is, in fact, equal to an element of 2^ω . In particular, if Γ^X is total for all $X \in 2^\omega$ then Γ is a continuous map $2^\omega \rightarrow 2^\omega$. If $\Gamma = W_e$, then for all X we also denote Γ^X by Φ_e^X when convenient.

For simplicity, we abuse notation and write Φ_e instead of Φ_e^\emptyset . (Formally, this is only incorrect up to a fixed computable permutation of \mathbb{N} . Indeed, given any computable set X there is a computable bijection $f : \mathbb{N} \rightarrow \mathbb{N}$ such that $\Phi_e^X = \Phi_{f(e)}$ for all $e \in \mathbb{N}$.) This highlights the fact that the main role of Turing functionals is to facilitate relativization of computability-theoretic notions to arbitrary subsets of \mathbb{N} . For example, a set $Y \subseteq \mathbb{N}$ is *computable relative to X* (or *from X* , or is *X -computable*), if $Y = \Gamma^X$ for some Turing functional Γ , in which case we write $Y \leq_T X$; Y is *computably enumerable relative to X* (or *X -c.e.*) if Y is the domain of Γ^X for some Turing functional Γ ; etc. Recall, too, that for each set X , the *jump* of X is the X -c.e. set $X' = \{e \in \mathbb{N} : \Phi_e^X(e) \downarrow\}$.

An important object in investigations like ours is the following.

DEFINITION 2.5. A class $\mathcal{C} \subseteq 2^\omega$ is a Π_1^0 class if there is a c.e. set W , viewed as a subset of $2^{<\omega}$, such that $\mathcal{C} = 2^\omega \setminus \bigcup_{\sigma \in W} [\sigma] = \{Y \in 2^\omega : (\forall \sigma \in W)[\sigma \not\prec Y]\}$.

If we take W in the definition to be X -c.e. rather than c.e., we get the relativized concept of a $\Pi_1^{0,X}$ class. Such classes are ubiquitous, often showing up as the collection of sets satisfying some natural computability-theoretic or combinatorial property. A prototypical example, given an infinite set X and a Turing functional Γ , is the class $\mathcal{C}_{X,\Gamma}$ of all pairs of sets (Y_0, Y_1) such that $Y_0 \cup Y_1 = X$ and for each $i < 2$, each $x \in \mathbb{N}$, and every finite subset F of Y_i , $\Gamma^F(x) \uparrow$. It is easy to verify that $\mathcal{C}_{X,\Gamma}$ is a $\Pi_1^{0,X}$ class.

Note that a Π_1^0 class is, in particular, a closed subset of 2^ω . (The additional property, worth emphasizing, is that a Π_1^0 class is one whose complement is effectively generated.) Every closed subset of 2^ω is also compact, which yields the following simple but significant result.

LEMMA 2.6 (Compactness for Π_1^0 classes). *If W is c.e. and $\mathcal{C} = 2^\omega \setminus \bigcup_{\sigma \in W} [\sigma] = \emptyset$, then there is an $\ell \in \mathbb{N}$ such that $\sigma \in 2^{<\omega}$ has an initial segment in W of length at most ℓ .*

For instance, if the class $\mathcal{C}_{X,\Gamma}$ mentioned above is empty, then compactness yields an ℓ such that for every partition of X into two sets, Y_0 and Y_1 , there is an $i < 2$ and a finite subset F of $Y_i \upharpoonright \ell$ with $\Gamma^F(x) \downarrow$ for some x . Our use of compactness will often take this form.

Equally important for us will be the case when a Π_1^0 class we are dealing with is non-empty. To study the members of such classes, we typically employ basis theorems of various kinds, a *basis* in this context being a collection of subsets of \mathbb{N} that intersects every non-empty Π_1^0 class. The most celebrated example of this is the low basis theorem of Jockusch and Soare [25, Theorem 2.1], which shows that the collection of low sets Y with $Y' \leq_T \emptyset'$ forms a basis. In this monograph, we will most often use the following *cone avoidance basis theorem*.

THEOREM 2.7 (Jockusch and Soare [24], Corollary 2.11). *Let $C \subseteq \mathbb{N}$ be non-computable. Every non-empty Π_1^0 class contains a member Y such that $C \not\leq_T Y$.*

Observe that to relativize the cone avoidance basis theorem to a set X , we need C above to be not only non-computable, but non- X -computable. Without this additional condition the result would be false, as can be easily seen, for example, by noticing that the singleton $\{X\}$ is a $\Pi_1^{0,X}$ class. This distinction—computing a given non-computable set on the one hand, and computing it together with a given other set on the other—turns out to be an important one, and we will return to it in the next chapter.

2.3. Second-order arithmetic and computable reducibility

As mentioned, our main focus in this manuscript is a computability-theoretic one. As such, our contributions to reverse mathematics here are

largely ancillary, and except where noted otherwise, will follow by straightforward formalization of our computability results. The framework of reverse mathematics nonetheless provides a convenient way to succinctly state many relationships between the various theorems we will be considering, and also motivates many questions we look at. Indeed, many of these questions would not arise otherwise. We thus begin with a brief overview of this framework.

Let L_2 denote the (two-sorted, first-order) language of second-order arithmetic. We use lowercase letters x, y, \dots to range over first-order variables, and uppercase letters X, Y, \dots to range over second-order variables. All formulas discussed may include both first- and second-order variables and parameters.

DEFINITION 2.8. The following axiomatic systems are defined in the language of second-order arithmetic.

- (1) PA^- consists of the algebraic axioms of Peano arithmetic (i.e., all axioms except for induction).
- (2) RCA_0 consists of the axioms of PA^- , together with Δ_1^0 *comprehension* (i.e., the scheme

$$(\forall x)[\phi(x) \iff \psi(x)] \rightarrow (\exists X)(\forall x)[x \in X \iff \phi(x)],$$

where ϕ is a Σ_1^0 formula and ψ is Π_1^0 and Σ_1^0 *induction* (i.e., the scheme

$$(\phi(0) \wedge (\forall x)[\phi(x) \rightarrow \phi(x+1)]) \rightarrow (\forall x)[\phi(x)]$$

where ϕ is a Σ_1^0 formula).

- (3) ACA_0 consists of the axioms of RCA_0 , together with *arithmetic comprehension* (i.e., the scheme

$$(\exists X)(\forall x)[x \in X \iff \phi(x)]$$

where ϕ is a Σ_n^0 formula for some $n \in \mathbb{N}$).

RCA_0 corresponds more or less to formalized computable mathematics, since by Post's theorem, being computable from a set is the same as being Δ_1^0 definable from it. Thus, morally, all effectively true theorems ought to be provable in RCA_0 . The one complicating factor in this is the restriction in RCA_0 to Σ_1^0 induction, as even effective arguments sometimes require induction beyond this level, and so may fail in a non-standard model of RCA_0 . While this can lead to interesting questions concerning the first-order content of mathematical principles, the majority of our results in this monograph can be readily formalized in RCA_0 . Therefore, we will follow the common practice of presenting all our arguments semantically (i.e., we will not give formal proofs in second-order arithmetic), and obtain provability results in RCA_0 implicitly.

The preceding definition lists two of the so-called “big five” subsystems of second-order arithmetic, as these will be the only ones of interest to us. In the classical program of reverse mathematics, RCA_0 serves as the base theory, over which implications between (formal versions of) various

mathematical theorems are considered, giving a measure of their relative proof-theoretic and computability-theoretic strength. Implications to and from ACA_0 over RCA_0 , in particular, constitute an important benchmark in this measurement, as we discuss further below.

We now discuss the models of RCA_0 and ACA_0 .

DEFINITION 2.9. A model of second-order arithmetic is a pair (N, \mathcal{S}) , where N is (the domain of) a model of first-order arithmetic and $\mathcal{S} \subseteq \mathcal{P}(N)$. If $N = \mathbb{N}$, then this is an ω -model.

Thus, an ω -model is specified entirely by the collection \mathcal{S} of subsets of \mathbb{N} that it includes. The following is immediate.

LEMMA 2.10. *Let $(\mathbb{N}, \mathcal{S})$ be an ω -model.*

- (1) $(\mathbb{N}, \mathcal{S}) \models \text{RCA}_0$ if and only if \mathcal{S} is closed under \oplus and under \leq_T (i.e., if \mathcal{S} is a Turing ideal).
- (2) $(\mathbb{N}, \mathcal{S}) \models \text{ACA}_0$ if and only if \mathcal{S} is closed under \oplus , \leq_T , and the map $X \mapsto X'$ (i.e., if \mathcal{S} is a jump ideal).

All the theorems we consider, from Milliken's tree theorem onward, can be expressed by Π_2^1 formulas in the language of second-order arithmetic, and more specifically, in the form given by Equation (1.1) above. As discussed in the introduction, we think of these as problems, in the following sense.

DEFINITION 2.11. An *instance-solution problem* (or just *problem*) is a relation $P \subseteq 2^\omega \times 2^\omega$. For every $(X, Y) \in P$, X is a *instance* of P (or *P-instance*) and Y is a *solution* to X for the problem P (or *P-solution* to X).

It should be noted that every Π_2^1 problem can be written in the syntactic form of Equation (1.1) in many different ways. In practice, however, there is a canonical such form one works with, and whenever we refer to a Π_2^1 statement in this monograph we will have this form in mind.

Not all instance-solution problems naturally come from Π_2^1 principles (see, e.g., [17, 26]), but this will be the case in all of the examples we consider. We will move freely between the two perspectives, as convenient. The main practical connection comes from the following definition and basic observation.

DEFINITION 2.12. Let P and Q be problems. Q is *computably reducible* to P , written $Q \leq_c P$, if every Q -instance X computes a P -instance \widehat{X} such that if \widehat{Y} is any P -solution to \widehat{X} then $X \oplus \widehat{Y}$ computes a Q -solution Y to X .

LEMMA 2.13. *Let P and Q be Π_2^1 statements. If $Q \leq_c P$ as problems, then every ω -model of $\text{RCA}_0 \wedge P$ is a model of Q .*

Computable reducibility is a convenient tool for making certain natural constructions in reverse mathematics more explicit. For example, the most common way of showing that a Π_2^1 statement P implies ACA_0 over RCA_0 is

to show that for every set $A \subseteq \mathbb{N}$, there is an A -computable \mathbf{Q} -instance X , all of whose solutions Y satisfy $A' \leq_T A \oplus Y$. If we let \mathbf{Q} be the problem whose instances are all $X \in 2^\omega$, such that the only solution to each X is X' , then the preceding precisely says that $\mathbf{Q} \leq_c \mathbf{P}$.

We conclude this section with a note on non-implications.

DEFINITION 2.14. Let \mathbf{P} be a problem.

- (1) \mathbf{P} admits *cone avoidance* if for all sets $A, C \subseteq \mathbb{N}$ with $C \not\leq_T A$, every A -computable \mathbf{P} -instance X has a solution Y so that $C \not\leq_T A \oplus Y$.
- (2) \mathbf{P} admits *strong cone avoidance* if for all sets $A, C \subseteq \mathbb{N}$ with $C \not\leq_T A$, every \mathbf{P} -instance X has a solution Y so that $C \not\leq_T A \oplus Y$.

The distinction to note well is that the instance X in item 2 can be arbitrary, and in particular, need *not* be A -computable. As pointed out in the introduction, all computably true principles satisfy cone avoidance, but not necessarily strong cone avoidance. Indeed, strong cone avoidance is a fairly special property which makes it possible to freely use a principle in a construction without increasing its overall complexity, as we will do, e.g., with the Halpern-Laüchli theorem in the next chapters.

Ordinary cone avoidance suffices for the following important result, which we will make repeated use of. We include a proof for completeness.

LEMMA 2.15. *If \mathbf{P} is a Π_2^1 statement that, as a problem, admits cone avoidance, then there is a ω -model of $\text{RCA}_0 \wedge \mathbf{P}$ in which ACA_0 does not hold. In particular, \mathbf{P} does not imply ACA_0 over RCA_0 .*

PROOF. Let $C = \emptyset'$. We inductively define $A_0, A_1, \dots \subseteq \mathbb{N}$ as follows. Let $A_0 = \emptyset$, and suppose we have defined A_s for some $s \in \mathbb{N}$ and that $C \not\leq_T A_s$. If $s \neq (e, t)$ for some $e \in \mathbb{N}$ and some $t < s$, or if $\Phi_e^{A_t}$ is not a \mathbf{P} -instance, then let $A_{s+1} = A_s$. Otherwise, by cone avoidance of \mathbf{P} choose a solution Y to $X = \Phi_e^{A_t}$ so that $C \not\leq_T A_s \oplus Y$, and let $A_{s+1} = A_s \oplus Y$.

Let $\mathcal{S} = \{Z : (\exists s)[Z \leq_T A_s]\}$, which is a Turing ideal since $A_t \leq_T A_s$ for all $t \leq s$. By construction, if X is any instance of \mathbf{P} in \mathcal{S} then \mathcal{S} contains a solution to X . (Indeed, if $X = \Phi_e^{A_t}$, say, let $s = (e, t)$; then a solution to X is computable from A_{s+1} .) It follows that $(\mathbb{N}, \mathcal{S})$ is a model of $\text{RCA}_0 \wedge \mathbf{P}$. But $\emptyset' \not\leq_T A_s$ for all $s \in \mathbb{N}$, hence $\emptyset' \notin \mathcal{S}$. This means \mathcal{S} is not a jump ideal and so $(\mathbb{N}, \mathcal{S})$ is not a model of ACA_0 . \square

2.4. Trees and strong subtrees

Trees have different meanings in different areas of mathematics, and what is noteworthy for us here, is that we will *not* be following the common definition used in computability theory.

DEFINITION 2.16. A *tree* is a non-empty subset T of $\omega^{<\omega}$ satisfying the following properties:

- (1) there exists $\rho \in T$, called a *root* of T , such that $\rho \preceq \sigma$ for all $\sigma \in T$;
- (2) if $\sigma, \tau \in T$ then $\sigma \wedge \tau \in T$;

- (3) for every $\sigma \in T$ there are at most finitely many $\tau \in T$ such that $\sigma \prec \tau$ and such that there is no $\tau' \in T$ with $\sigma \prec \tau' \prec \tau$.

Thus, in brief, our trees are rooted, meet-closed, finitely-branching subsets of $\omega^{<\omega}$. However, they need not be downward closed under the initial segment, \preceq , relation, as is the case with the trees commonly used in computability theory. Thus, every tree in the sense of the latter is also a tree in our sense here, but not conversely. Our trees also differ from those used in the context of the so-called Chubb-Hirsset-McNicholl tree theorem, which we will discuss shortly. There, trees are also not necessarily downward closed, but nor are they closed under meets.

Moving forward, we will use trees exclusively in the sense of Definition 2.16, except in Chapter 7 where we deliberately look at the relationship of the two.

As usual, we will refer to the elements of a tree as its *nodes*.

DEFINITION 2.17. Let T be a tree.

- (1) The *level* of $\sigma \in T$ is $|\{\tau \in T : \tau \prec \sigma\}|$. We say σ is *at* this level in T .
- (2) For $n \in \mathbb{N}$, $T(n)$ denotes the set of all $\sigma \in T$ at level n in T .
- (3) The *height* of T is the least ordinal α larger than the level of every $\sigma \in T$.
- (4) If $\sigma, \tau \in T$ with $\sigma \prec \tau$ and there is no $\tau' \in T$ with $\sigma \prec \tau' \prec \tau$, then τ is a *direct extension* of σ in T .
- (5) For $k \in \omega$, a node $\sigma \in T$ is *k-branching* in T if it has exactly k many direct extensions in T .
- (6) A node $\sigma \in T$ is a *leaf* of T if it is 0-branching in T . The set of leaves of T is denoted by $\text{leaves}(T)$.
- (7) T is *k-branching* if every $\sigma \in T$ is k -branching in T or a leaf.

Note that all direct extensions of a given node in a tree T must be pairwise incomparable. The height of a tree is always at most ω , and as trees are non-empty, the height is always defined and at least 1. Since all trees are finitely-branching by definition, a tree is of height ω if and only if it is infinite.

REMARK 2.18. It is worth stressing that if two nodes of T are at the same level, they need *not* have the same length. This is because length is not a structural property of a tree as a graph, but rather of its presentation (i.e., the labeling of its nodes). The same is true of being closed under meets. Thus, in general, any result we state or prove for trees will apply also, after appropriate relabeling, to any subset S of $\omega^{<\omega}$ such that (S, \preceq) is isomorphic to (T, \preceq) for some tree T . For any such set S we can freely employ the terms in the preceding definition, since these are independent of presentation.

DEFINITION 2.19. Given $b : \omega \rightarrow \omega$, a tree T is *b-bounded*, or *bounded by b*, if for every $\sigma \in T$ we have $\sigma(i) < b(i)$ for all $i < |\sigma|$. T is *computably bounded* if T is *b-bounded* for some computable b .

A k -branching tree is thus one which is bounded by precisely the functions whose ranges lie in the interval $[k, \infty)$. Clearly, every finitely branching tree is computably bounded relative to its Turing jump.

Notice, however, that because our trees are not closed downwards under \preceq , computably bounded trees here do not necessarily enjoy the usual effectivity properties familiar from computability theory (see, e.g., [42], Chapter 3). For example, the set of infinite paths through a computable, computably bounded tree need not be a Π_1^0 class.

A subset S of a tree T may not itself be a tree, and even if it is, it may not preserve all the structure of T . For example, two nodes at the same level in S may be at different levels in T , or a node may have fewer direct extensions in S than it did in T . This motivates the following definition.

DEFINITION 2.20. A tree S of height α is a *strong subtree* of a tree T if it satisfies the following two properties:

- (1) there exists a function $f : \alpha \rightarrow \omega$, called a *level function*, such that for all $n < \alpha$, if $\sigma \in S(n)$ then $\sigma \in T(f(n))$;
- (2) for all k , a node in S which is not at level $\alpha - 1$ in S is k -branching in S if and only if it is k -branching in T .

See Figure 2.1 for a visual representation of a strong subtree. Given a tree T and $1 \leq \alpha \leq \omega$, we let $\mathcal{S}_\alpha(T)$ be the collection of all strong subtrees of T of height α .

A strong subtree S of a tree T is itself a tree, and so is closed under meets. The branching in S is thus completely determined by the direct extensions in T of the (non-trivial) meets of nodes in S . The level function f ensures that if $\sigma \in S \cap T(f(n))$ is not a leaf of S , then for every $\tau \in T(f(n) + 1)$ extending σ , there exists a unique $\rho \in S \cap T(f(n) + 1)$ extending τ . (See Figure 2.1.)

If the height of T is $\alpha < \omega$ then $\mathcal{S}_\beta(T) = \emptyset$ for all $\beta > \alpha$, and it is also easy to see that the only element of $\mathcal{S}_\alpha(T)$ in this case is T itself. Being a strong subtree of a tree is a transitive relation, so in particular, if $S \in \mathcal{S}_\alpha(T)$ and $U \in \mathcal{S}_\beta(S)$ for some $\beta \leq \alpha$ then $U \in \mathcal{S}_\beta(T)$.

2.5. Forests and products of trees

As mentioned above, in order to study the proof of Milliken's tree theorem we will need to examine the Halpern-Laüchli theorem, whose statements requires us to consider multiple trees in parallel.

DEFINITION 2.21. A *forest* is a non-empty subset X of $\omega^{<\omega}$ such that if a pair of nodes $\sigma, \tau \in X$ has a common initial segment in X then also $\sigma \wedge \tau \in X$.

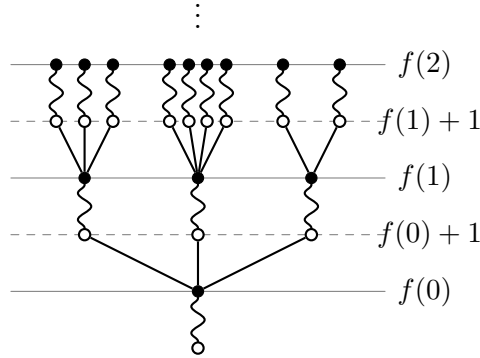

FIGURE 2.1. A strong subtree S of a tree T , with level function f . The circles represent nodes in T ; the solid circles in S , the hollow circles are in $T \setminus S$. The levels of S are included in the levels of T ; solid gray horizontal lines represent levels in S , dashed gray horizontal lines levels in $T \setminus S$. A node connected to another below it by a straight black line denotes a direct extension in T . Wavy lines indicate omitted (skipped over) portions of T . Note that all branchings are preserved: a nodes in S has the same number of direct extensions in S as in T .

Since every pair of nodes in a tree has at least one common initial segment (the root), it is clear that every tree is a forest. Indeed, the following is easy to see: $X \subseteq \omega^{<\omega}$ is a forest if and only if it is a union of disjoint trees. For this reason, we refer to the elements of a forest as nodes, and lift all other terminology from trees to forests. For definiteness, we make this explicit in the following definition.

DEFINITION 2.22. Let X be a forest.

- (1) A *root* of X is any $\rho \in T$ having no proper initial segment in X . The set of all roots of X is denoted by $\text{roots}(X)$.
- (2) The *level* of $\sigma \in X$ is $|\{\tau \in X : \tau \prec \sigma\}|$. We say σ is *at* this level in X .
- (3) For $n \in \mathbb{N}$, $X(n)$ denotes the set of all $\sigma \in X$ at level n in X .
- (4) The *height* of X is the least ordinal α larger than the level of every $\sigma \in X$.
- (5) If $\sigma, \tau \in X$ with $\sigma \prec \tau$ and there is no $\tau' \in X$ with $\sigma \prec \tau' \prec \tau$, then τ is a *direct extension* of σ in X .
- (6) For $k \in \omega$, a node $\sigma \in X$ is *k-branching* in X if it has exactly k many direct extensions in X .
- (7) A node $\sigma \in X$ is a *leaf* of X if it is 0-branching. The set of leaves of X is denoted $\text{leaves}(X)$.

Thus, a forest X is a tree if and only if $\text{roots}(X)$ is a singleton. The height of X is the maximum of the heights of the disjoint trees that comprise it.

Given a forest X and a node $\sigma \in X$, we let $X \upharpoonright \sigma = \{\tau \in X : \tau \succeq \sigma\}$. In particular, whenever $\sigma \in X$ we have that $X \upharpoonright \sigma$ is a tree with root σ .

DEFINITION 2.23. A forest Y of height $\alpha \leq \omega$ is a *strong subforest* of a forest X if it satisfies the following two properties:

- (1) there exists a function $f : \alpha \rightarrow \omega$, called a *level function*, such that for all $n \leq \alpha$, if $\sigma \in X(n)$ then $\sigma \in X(f(n))$;
- (2) for all k , a node in Y which is not at level α in Y is k -branching in Y if and only if it is k -branching in X .

Given a forest X and an $\alpha \leq \omega$, we let $\mathcal{S}_\alpha(X)$ be the collection of all strong subforests of X of height α . We also add the following slightly more general definition.

DEFINITION 2.24. For each $d \geq 1$, if T_0, \dots, T_{d-1} are trees then

$$\mathcal{S}_\alpha(T_0, \dots, T_{d-1})$$

for $\alpha \leq \omega$ is the collection of all tuples (S_0, \dots, S_{d-1}) such that for each $i < d$ we have $S_i \in \mathcal{S}_\alpha(T_i)$, witnessed by one and the same level function. In addition, $\mathcal{S}_{<\alpha}(T_0, \dots, T_{d-1})$ denotes $\bigcup_{n < \alpha} \mathcal{S}_n(T_0, \dots, T_{d-1})$.

Thus, if $X = \bigcup_{i < d} T_i$, where T_0, \dots, T_{d-1} are disjoint trees, then $\mathcal{S}_\alpha(X) = \mathcal{S}_\alpha(T_0, \dots, T_{d-1})$. However, the preceding definition applies to arbitrary trees T_0, \dots, T_{d-1} , disjoint or not.

We include one final definition, which is standard in other investigations of Milliken's tree theorem and will be important to us going forward.

DEFINITION 2.25. Fix $m \geq 1$.

- (1) For a forest X and node $\sigma \in X$, a subset P of X is *m - σ -dense* if every $\tau \in X(m)$ that extends σ has an extension in P .
- (2) For forests X_0, \dots, X_{d-1} and tuple $\pi = (\sigma_0, \dots, \sigma_{d-1}) \in \bigcup_n X_0(n) \times \dots \times X_{d-1}(n)$, a subset P of $X_0 \times \dots \times X_{d-1}$ is an *m - π -dense matrix* if $P = P_0 \times \dots \times P_{d-1}$ where P_i is an m - σ_i -dense subset of X_i , for each $i < d$.

We will of course only be interested in the case where m is larger than the level of σ in X , respectively, of the (common) level in X_i of each of the entries σ_i of π . In the latter case, we will call this common level the *level of π in X* .

The main point in item 2 above is that if P is an m - π -dense matrix then for every $\tau_i \in X_i(m)$ that extends σ_i we can find a ρ_i such that $(\rho_0, \dots, \rho_{d-1}) \in P$, and the latter is true for every choice of possible ρ_i . Note that the ρ_i do not have to be at the same level in their respective forests. Also, notice that the X_i need not be disjoint, and so their union need not be itself a forest.

2.6. Statements of theorems

In this section, we can finally define Milliken’s tree theorem and its combinatorial variants that we will investigate in Chapters 3 and 4, as well as the various application of Milliken’s tree theorem that we will discuss in Chapters 5 to 7.

THEOREM 2.26 (Milliken’s tree theorem). *Let T be an infinite tree with no leaves. For all $n, k \geq 1$ and all $f : \mathcal{S}_n(T) \rightarrow k$ there is an $S \in \mathcal{S}_\omega(T)$ such that f is constant on $\mathcal{S}_n(S)$.*

By analogy with Ramsey’s theorem, we will break this statement up into sub-statements, in this case according to the height of the subtrees being colored. Thus, we define the following:

STATEMENT 2.27. For all $n \geq 1$, MTT^n is the restriction of Milliken’s tree theorem to colorings to strong subtrees of height n .

We will sometimes also refer to MTT^n as *Milliken’s tree theorem for height n* in the sequel. From the computability-theoretic point of view, we will regard an instance of MTT^n as being a tuple (T, b, f, k) , where T is an infinite b -bounded tree with no leaves, and f is a map $\mathcal{S}_n(T) \rightarrow k$. In effect, this means all computable instances of MTT^n are computably bounded.

As discussed in the introduction, the next theorem is the analogue of the pigeonhole principle in the proof of Milliken’s tree theorem.

THEOREM 2.28 (Halpern-Laüchli theorem). *Let T_0, \dots, T_{d-1} be infinite trees with no leaves. For all $k \geq 1$ and all $f : \bigcup_n T_0(n) \times \dots \times T_{d-1}(n) \rightarrow k$ there exists $(S_0, \dots, S_{d-1}) \in \mathcal{S}_\omega(T_0, \dots, T_{d-1})$ such that f is constant on $\bigcup_n S_0(n) \times \dots \times S_{d-1}(n)$.*

Again, one would naturally expect MTT^1 to play this role, so the need for the Halpern-Laüchli theorem is not a priori obvious. In fact, the original paper [30] that introduced what we now call Milliken’s tree theorem actually proved a version for products that looks much more like the “general case” of the Halpern-Laüchli theorem. In many ways, this is really the more natural result, and Milliken’s tree theorem is merely a restriction that suffices for most applications.

THEOREM 2.29 (Product version of Milliken’s tree theorem). *Fix infinite trees T_0, \dots, T_{d-1} with no leaves. For all $n, k \geq 1$ and all colorings $f : \mathcal{S}_n(T_0, \dots, T_{d-1}) \rightarrow k$ there exists $(S_0, \dots, S_{d-1}) \in \mathcal{S}_\omega(T_0, \dots, T_{d-1})$ such that f is constant on $\mathcal{S}_n(S_0, \dots, S_{d-1})$.*

STATEMENT 2.30. For all $n \geq 1$, PMTT^n is the restriction of the product version of Milliken’s tree theorem for height n .

The Halpern-Laüchli theorem is exactly PMTT^1 , since for all T_0, \dots, T_{d-1} we have

$$\mathcal{S}_1(T_0, \dots, T_{d-1}) = \bigcup_n T_0(n) \times \dots \times T_{d-1}(n).$$

In our analysis, we will regard an instance of PMTT^n as a tuple

$$(d, T_0, \dots, T_{d-1}, b, f, k),$$

where the T_i are infinite b -bounded trees with no leaves, and f is a map $\mathcal{S}_n(T_0, \dots, T_{d-1}) \rightarrow k$.

We now state some further applications of Milliken's tree theorem, which concern various structures besides trees. Each of these structures will be countable and, unless otherwise stated, infinite, and will have a countable, relational underlying language. For a finite substructure \mathcal{A} of a structure \mathcal{B} , let $\binom{\mathcal{B}}{\mathcal{A}}$ denote the set of (isomorphic) copies of \mathcal{A} contained in \mathcal{B} . Recall also that if X is a set and n is a positive integer then $[X]^n$ denotes the set of n -element subsets of X . In particular, if B is the domain of \mathcal{B} , then each element of $[B]^n$ may be regarded as a substructure of \mathcal{B} by restriction since the language of \mathcal{B} is relational. (In general, however, $[B]^n$ need not equal $\binom{\mathcal{B}}{\mathcal{A}}$ for any one \mathcal{A} .) When convenient, we may also write $[\mathcal{B}]^n$ for $[B]^n$.

The first application of Milliken's tree theorem we consider is *Devlin's theorem*, also called *Devlin's second theorem*, e.g., in [48], Chapter 6.

THEOREM 2.31 (Devlin's theorem). *For every $n \geq 1$ there exists $\ell \geq 1$ such that for every $k \geq 1$ and every $f : [\mathbb{Q}]^n \rightarrow k$ there is a dense suborder S of \mathbb{Q} with no endpoints satisfying $|f([S]^n)| \leq \ell$.*

The key here is that the bound ℓ does not depend on k or the particular coloring, but only on n . As an instance-solution problem, we will study Devlin's theorem in the following form:

STATEMENT 2.32. For all $n, k, \ell \geq 1$, $\text{DT}_{k,\ell}^n$ is the assertion that for every $f : [\mathbb{Q}]^n \rightarrow k$ there is a dense suborder S of \mathbb{Q} with no endpoints satisfying $|f([S]^n)| \leq \ell$.

Note that $\text{DT}_{k,\ell}^n$ is merely a formal statement, not a necessarily a true theorem for all possible n, k , and ℓ . For example, it is easy to see that $\text{DT}_{k,1}^1$ is true for all k . However, $\text{DT}_{2,1}^2$ is false. To see this, let $(q_n)_{n \in \mathbb{N}}$ be an enumeration of the rationals, and define $f : [\mathbb{Q}]^2 \rightarrow 2$ by letting $f(q_n, q_m) = 0$ if $q_n < q_m \iff n < m$, and $f(q_n, q_m) = 1$ otherwise. Then it is readily seen that every subset $S \subseteq \mathbb{Q}$ of order-type \mathbb{Q} (or even \mathbb{Z}) must contain pairs of both colors under f . For $n = 2$, this situation turns out to be as bad as it can be, as $\text{DT}_{k,2}^2$ is true for all k . This fact was originally observed by Galvin (unpublished). For general n , the corresponding ℓ values were obtained by Devlin [9, Chapter 4].

The second application we consider concerns graph colorings. We use \mathcal{G} as generic notation for a graph, and unless otherwise specified, assume the set of vertices of \mathcal{G} is G , and the set of edges, E . For $x, y \in G$, we write xEy if $(x, y) \in E$ and $\neg xEy$ if $(x, y) \notin E$. The graph \mathcal{G} is a *Rado graph* (or *random graph*) if for every two disjoint finite sets of vertices $F_0, F_1 \subseteq G$ there exists $x \in G$ such that xEy for all $y \in F_0$ and $\neg xEy$ for all $y \in F_1$. Such a graph is, in particular, universal, containing every finite graph as an

induced subgraph. All Rado graphs are isomorphic by the standard back and forth construction, so we usually speak just of *the* Rado graph, and assume we have fixed a canonical computable representative of it, denoted by \mathcal{R} . The principle of interest to us is following, which we will call the *Rado graph theorem* here for definiteness.

THEOREM 2.33 (Rado graph theorem). *For every finite graph \mathcal{G} there exists $\ell \geq 1$ such that for every $k \geq 1$ and every $f : \binom{\mathcal{R}}{\mathcal{G}} \rightarrow k$ there is an isomorphic subgraph \mathcal{R}' of \mathcal{R} satisfying $|f''(\mathcal{R}')| \leq \ell$.*

Again, the bound ℓ does not depend on k , but only, in this case, on the particular subgraph \mathcal{G} . The precise bounds here were obtained by Sauer [36] and Laflamme, Sauer, and Vuksanovic [27]. The result shares much in common with Devlin’s theorem, as we will see further below. Both results are well-known consequences of Milliken’s theorem. (See, e.g., Todorcevic [48], Theorems 6.23 and 6.25 for direct proofs.) We give a more effective proof of the Rado graph theorem from Milliken’s tree theorem in Section 6.3.

We will investigate the Rado graph theorem in the following two forms.

STATEMENT 2.34. For all finite graphs \mathcal{G} and all $k, \ell \geq 1$, $\text{RG}_{k,\ell}^{\mathcal{G}}$ is the assertion that for every coloring $f : \binom{\mathcal{R}}{\mathcal{G}} \rightarrow k$, there is an isomorphic subgraph \mathcal{R}' of \mathcal{R} satisfying $|f''(\mathcal{R}')| \leq \ell$.

STATEMENT 2.35. For all $n, k, \ell \geq 1$, $\text{RG}_{k,\ell}^n$ is the assertion that for every coloring $f : [\mathcal{R}]^n \rightarrow k$, there is an isomorphic subgraph \mathcal{R}' of \mathcal{R} satisfying $|f''[\mathcal{R}']^n| \leq \ell$.

Since there are, up to isomorphism, only finitely many graphs G of a given finite size, we immediately get the implication

$$(\forall \mathcal{G})(\exists \ell)(\forall k)[\text{RG}_{k,\ell}^{\mathcal{G}}] \rightarrow (\forall n)(\exists \ell)(\forall k)[\text{RG}_{k,\ell}^n].$$

The final application we look at, unlike the previous two, is not a familiar one in set theory. However, it has been studied extensively in computable combinatorics and reverse mathematics (see, e.g., [6, 7, 5, 15, 32] for some very recent papers). This is the tree theorem of Chubb, Hirst, and McNicholl [8], which we will refer to as the *Chubb-Hirst-McNicholl (CHM) tree theorem* in this monograph, to avoid confusion with Milliken’s tree theorem. The CHM tree theorem concerns a weaker structure of tree than in Definition 2.16, where we do not insist on being closed under meets. A tree is thus any subset of $2^{<\omega}$ with a root. The theorem asserts the existence, for every finite coloring of the n -tuples of *comparable* nodes of $2^{<\omega}$, of an infinite monochromatic perfect subtree in this weaker sense. The restriction to comparable nodes comes from wanting to extend Ramsey’s theorem to these “weak” trees. And indeed, as in Devlin’s theorem, it is easy to devise a coloring of arbitrary tuples of nodes here where no monochromatic solution exists (e.g., consider coloring all comparable pairs of strings 0, and all incomparable pairs of strings 1). As it turns out, this restriction loses

a great deal of combinatorial structure, which becomes apparent if we look not for monochromatic solutions, but merely for bounds on the numbers of colors used in a solution. It is this generalization of the CHM tree theorem that we investigate.

THEOREM 2.36 (Generalized CHM tree theorem). *For every $n \geq 1$ there exists $\ell \geq 1$ such that for every $k \geq 1$ and every $f : [2^{<\omega}]^n \rightarrow k$ there is an $S \subseteq 2^{<\omega}$ such that (S, \preceq) is isomorphic to $(2^{<\omega}, \preceq)$ and $|f([S]^n)| \leq \ell$.*

STATEMENT 2.37. For all $n, k, \ell \geq 1$, $\text{CHMTT}_{k,\ell}^n$ is the assertion that for every $f : [2^{<\omega}]^n \rightarrow k$ there is an $S \subseteq 2^{<\omega}$ such that (S, \preceq) is isomorphic to $(2^{<\omega}, \preceq)$ and $|f([S]^n)| \leq \ell$.

As with the previous two principles, the CHM tree theorem is a consequence of Milliken's tree theorem. We include a proof in Theorem 7.9 below.

2.7. Big Ramsey degrees and structures

Though we will study each of Devlin's theorem, the Rado graph theorem, and the CHM tree theorem separately and in its own right, we mention a common framework within which all three can be presented, and which better highlights some of the main similarities between the three. Some of the terminology here will also be convenient in our discussions later on.

All three principles can be stated more succinctly using the concept of big Ramsey degrees, which we now review. Recall that if \mathcal{B} is an infinite structure and \mathcal{A} is a finite substructure of \mathcal{B} , then for positive numbers $\ell \leq k$ the notation

$$\mathcal{B} \rightarrow (\mathcal{B})_{k,\ell}^{\mathcal{A}}$$

means that for every coloring $f : \binom{\mathcal{B}}{\mathcal{A}} \rightarrow k$ there exists an isomorphic substructure \mathcal{B}' of \mathcal{B} such that $|f''(\binom{\mathcal{B}'}{\mathcal{A}})| \leq \ell$. The following terminology is standard in structural Ramsey theory.

DEFINITION 2.38. Let \mathcal{B} be a structure.

- For a finite substructure \mathcal{A} of \mathcal{B} , the *big Ramsey degree of \mathcal{A} in \mathcal{B}* is the least number $\ell \in \omega$, if it exists, such that $\mathcal{B} \rightarrow (\mathcal{B})_{k,\ell}^{\mathcal{A}}$ for all $k \in \omega$, in which case we say that the big Ramsey degree of \mathcal{A} is *finite*.
- We say that a structure \mathcal{B} *has finite big Ramsey degrees* if, for every finite substructure \mathcal{A} of \mathcal{B} has finite big Ramsey degree.

In the parlance of this definition, then, the Rado graph theorem is simply the assertion that the Rado graph has finite big Ramsey degrees. Similarly, Devlin's theorem is the assertion that $(\mathbb{Q}, <)$ has finite big Ramsey degrees, since up to isomorphism $(\mathbb{Q}, <)$ has exactly one finite substructure \mathcal{A} of each size $n \geq 1$, and so $\binom{(\mathbb{Q}, <)}{\mathcal{A}} = [\mathbb{Q}]^n$. For the generalized CHM tree theorem the situation is slightly different. While $(2^{<\omega}, \preceq)$ can have more than one non-isomorphic substructure of a given finite size, it still has only finitely many.

Thus, the generalized CHM tree theorem is equivalent to the statement that $(2^{<\omega}, \preceq)$ has finite big Ramsey degrees.

The bounds ℓ in each of Devlin’s theorem, the Rado graph theorem, and the generalized CHM tree theorem are not determined purely by properties of the underlying structures. For example, even though \mathbb{Q} has only one substructure of size 2 up to isomorphism, we saw that we could differentiate two *types* of substructure of size 2 by enriching the structure by an enumeration of the domain. Enrichments of this kind play an important role in these computations, since they can be taken into account in designing colorings with a certain number of unavoidable colors.

A precise formalization of the concept of “enrichment” is given by Zucker [51].

DEFINITION 2.39 (Zucker [51], Definition 1.3). Let \mathcal{B} be a structure in a language \mathcal{L} . A *big Ramsey structure for \mathcal{B}* is a structure $\hat{\mathcal{B}}$ in a language $\hat{\mathcal{L}}$ satisfying the following properties:

- (1) $\mathcal{L} \subseteq \hat{\mathcal{L}}$;
- (2) the restriction of $\hat{\mathcal{B}}$ to \mathcal{L} is \mathcal{B} ;
- (3) for every finite substructure \mathcal{A} of \mathcal{B} there is a number $t_{\hat{\mathcal{B}}}(\mathcal{A})$ such that, up to isomorphism, there are exactly $t_{\hat{\mathcal{B}}}(\mathcal{A})$ many different substructures $\hat{\mathcal{A}}$ of $\hat{\mathcal{B}}$ whose restriction to \mathcal{L} is a copy of \mathcal{A} ;
- (4) every finite substructure \mathcal{A} of \mathcal{B} has big Ramsey degree equal to $t_{\hat{\mathcal{B}}}(\mathcal{A})$;
- (5) for every finite substructure \mathcal{A} of \mathcal{B} and choice $\hat{\mathcal{A}}_0, \dots, \hat{\mathcal{A}}_{t_{\hat{\mathcal{B}}}(\mathcal{A})-1}$ of substructures of $\hat{\mathcal{B}}$ as in property 3, the coloring $f : \binom{\hat{\mathcal{B}}}{\mathcal{A}} \rightarrow t_{\hat{\mathcal{B}}}(\mathcal{A})$ mapping each copy of \mathcal{A} in $\hat{\mathcal{B}}$ to the unique $i < t_{\hat{\mathcal{B}}}(\mathcal{A})$ such that \mathcal{A}' , viewed as a substructure of $\hat{\mathcal{B}}$ by restriction, is isomorphic to $\hat{\mathcal{A}}_i$ witnesses that the big Ramsey degree of \mathcal{A} in \mathcal{B} is at least $t_{\hat{\mathcal{B}}}(\mathcal{A})$.

The idea here is that for every finite substructure \mathcal{A} of \mathcal{B} , the substructures $\hat{\mathcal{A}}_0, \dots, \hat{\mathcal{A}}_{t_{\hat{\mathcal{B}}}(\mathcal{A})}$ of $\hat{\mathcal{B}}$ satisfying property 3 represent all recognizable or describable types of the copies of \mathcal{A} in \mathcal{B} , and the additional structure of $\hat{\mathcal{B}}$ facilitates these descriptions. In the literature, these instances are called more specifically *embedding types* or *Devlin types* based on the specific structure \mathcal{B} .

Zucker [51, Theorem 7.1] provides some sufficient (and somewhat technical) conditions for a structure to admit a big Ramsey structure. For our purposes here, it is enough to know that each of (\mathbb{Q}, \leq) , the Rado graph, and $(2^{<\omega}, \preceq)$ does. We will study the big Ramsey structure of the Rado graph in detail (see also [51], Section 6.3), and we will carefully develop the appropriate notion of type in the sense of the big Ramsey structure for the generalized CHM tree theorem. For an account of a big Ramsey structure for (\mathbb{Q}, \leq) , see [51, Section 6.2].

CHAPTER 3

The Halpern-Laüchli theorem

We begin our analysis of Milliken's tree theorem by studying the computable content of the Halpern-Laüchli theorem (Theorem 2.28). The two main theorems of this chapter are Theorem 3.4, that the Halpern-Laüchli theorem is computably true, and Theorem 3.21, that it admits strong cone avoidance. The first result will be used in the proof that the product version of Milliken's tree theorem admits arithmetical solutions. The second result will be used to prove that the product version of Milliken's tree theorem for colorings of strong subtrees of height 2 admits cone avoidance, in the same way that strong cone avoidance of the pigeonhole principle can be used to prove cone avoidance of Ramsey's theorem for pairs (see, e.g., Hirschfeldt [20], Section 6.7).

3.1. An effective proof of the Halpern-Laüchli theorem

Our effectivization of the the Halpern-Laüchli theorem is based on the proof of that theorem given in Todorcevic [48], where it appears as Theorem 3.2. We include that proof here largely in full, emphasizing the effective analysis when it shows up, with the exception of one technical lemma that we present first. For trees T_0, \dots, T_{d-1} and a tuple $\pi \in T_0(n) \times \dots \times T_{d-1}(n)$ for some $n \in \mathbb{N}$, we call n the *level* of π .

LEMMA 3.1 (Halpern and Laüchli [19], Theorem 1). *Let T_0, \dots, T_{d-1} be infinite tree with no leaves. For all $k \geq 1$ and all $g : T_0 \times \dots \times T_{d-1} \rightarrow k$ there is a $\pi \in \bigcup_n T_0(n) \times \dots \times T_{d-1}(n)$, an m larger than the level of π , and an m - π -dense matrix P for T_0, \dots, T_{d-1} on which g is constant.*

Nota bene that the coloring g above is defined on the full product $T_0 \times \dots \times T_{d-1}$, rather than the level product $\bigcup_n T_0(n) \times \dots \times T_{d-1}(n)$. However, we can obtain a level version, as follows.

LEMMA 3.2. *Let T_0, \dots, T_{d-1} be infinite trees with no leaves. For all $k \geq 1$ and all $f : \bigcup_n T_0(n) \times \dots \times T_{d-1}(n) \rightarrow k$ there is a $\pi \in \bigcup_n T_0(n) \times \dots \times T_{d-1}(n)$, an m larger than the level of π , and an m - π -dense matrix $P \subseteq \bigcup_n T_0(n) \times \dots \times T_{d-1}(n)$ on which f is constant.*

PROOF (FROM THEOREM 3.2 IN [48]). Fix T_0, \dots, T_{d-1} . By compactness, for every $k \geq 1$ there is an $n_k \geq 1$ such that for every coloring

$g : T_0 \times \cdots \times T_{d-1} \rightarrow k$ we can find a π , an m , and an m - π -dense matrix $P = P_0 \times \cdots \times P_{d-1}$ as in Lemma 3.1 with $P_i \subseteq \bigcup_{n < n_k} T_i(n)$ for all $i < d$.

Consider now $f : \bigcup_n T_0(n) \times \cdots \times T_{d-1}(n) \rightarrow k$. We define $g : T_0 \times \cdots \times T_{d-1} \rightarrow k$ as follows. First, for each $\sigma \in \bigcup_{n < n_k} T_i(n)$ fix an extension $\hat{\sigma} \in T_i(n_k)$. Now for all $(\sigma_0, \dots, \sigma_{d-1}) \in T_0 \times \cdots \times T_{d-1}$, set

$$g(\sigma_0, \dots, \sigma_{d-1}) = \begin{cases} f(\hat{\sigma}_0, \dots, \hat{\sigma}_{d-1}) & \text{if } \sigma_i \in \bigcup_{n < n_k} T_i(n) \text{ for all } i < d, \\ 0 & \text{otherwise.} \end{cases}$$

By choice of n_k there is a $\pi \in \bigcup_n T_0(n) \times \cdots \times T_{d-1}(n)$, an m larger than the level of π , and an m - π -dense matrix $Q = Q_0 \times \cdots \times Q_{d-1}$ such that $Q_i \subseteq \bigcup_{n < n_k} T_i(n)$ for all $i < d$ and g is constant on Q . For each $i < d$, let $P_i = \{\hat{\rho} : \rho \in Q\}$, so that now $P_i \subseteq T_i(n_k)$. By definition of g , we have that f is constant on $P = P_0 \times \cdots \times P_{d-1}$. Thus, π , m , and P are as desired. \square

One final critical lemma for us is the following, which is a consequence of the previous one. We include the proof for completeness.

LEMMA 3.3. *Let T_0, \dots, T_{d-1} be infinite trees with no leaves. For all $k \geq 1$ and all $f : \bigcup_n T_0(n) \times \cdots \times T_{d-1}(n) \rightarrow k$ there is a tuple $\pi \in \bigcup_n T_0(n) \times \cdots \times T_{d-1}(n)$ such that for every m larger than the level of π there is an m - π -dense matrix $P \subseteq \bigcup_n T_0(n) \times \cdots \times T_{d-1}(n)$ on which f is constant.*

PROOF (FOLLOWING THEOREM 3.2 IN [48]). Suppose otherwise. Then for every $(\sigma_0, \dots, \sigma_{d-1}) \in \bigcup_n T_0(n) \times \cdots \times T_{d-1}(n)$ there is an $m \geq 1$ such that f is not constant on any m - π -dense matrix $P \subseteq \bigcup_n T_0(n) \times \cdots \times T_{d-1}(n)$. Let m_π be the least such m . Then choose $m_0 < m_1 < \cdots$ so that $m_0 = 0$ and for all $s \geq 0$, $m_\pi < m_{s+1}$ for all tuples $\pi \in \bigcup_{n \leq m_s} T_0(n) \times \cdots \times T_{d-1}(n)$. For each $i < d$, define $S_i = \bigcup_s T_i(m_s)$, and note that the structure (S_i, \preceq) is isomorphic to a tree, so $S_0 \times \cdots \times S_{d-1}$ can be regarded as a product of trees. Using Remark 2.18, apply Lemma 3.2 to the restriction of f to $S_0 \times \cdots \times S_{d-1}$ to get a tuple $\pi \in \bigcup_n S_0(n) \times \cdots \times S_{d-1}(n)$, an m larger than the level of π in this product, and an m - π -dense matrix $P \subseteq \bigcup_n S_0(n) \times \cdots \times S_{d-1}(n)$ on which f is constant. But by construction, the level of π must be equal to m_s for some s , and m must be equal to m_t for some $t > s$. So f cannot, in fact, be constant on P , which is a contradiction. \square

We now come to proving our first main theorem of this chapter.

THEOREM 3.4. *The Halpern-Laüchli theorem is computably true (i.e., every instance computes a solution for itself).*

PROOF. Fix an instance of the Halpern-Laüchli theorem, which is to say, infinite trees T_0, \dots, T_{d-1} with no leaves (and which, recall, we take to be presented with an explicit bound) and a coloring $f : \bigcup_n T_0(n) \times \cdots \times T_{d-1}(n) \rightarrow k$ for some $k \geq 1$. We exhibit an $(f \oplus T_0 \oplus \cdots \oplus T_{d-1})$ -computable

solution, i.e., $(S_0, \dots, S_{d-1}) \in \mathcal{S}_\omega(T_0, \dots, T_{d-1})$ such that f is constant on $\bigcup_n S_0(n) \times \dots \times S_{d-1}(n)$.

Fix, non-effectively, a $\pi = (\sigma_0, \dots, \sigma_{d-1}) \in \bigcup_n T_0(n) \times \dots \times T_{d-1}(n)$ as in Lemma 3.3, and say m_0 is the level of π . By the pigeonhole principle, we can also fix a $j < k$ such that for every $m > m_0$ there is an m - π -dense matrix $P \subseteq \bigcup_n T_0(n) \times \dots \times T_{d-1}(n)$ such that $f(\tau_0, \dots, \tau_{d-1}) = j$ for all $(\tau_0, \dots, \tau_{d-1}) \in P$. Call such a P *good above m* .

Notice that given $m > m_0$ and a set $P \subseteq \bigcup_n T_0(n) \times \dots \times T_{d-1}(n)$, it is computable in f and the T_i whether or not P is good above n . Hence, we can $(f \oplus T_0 \oplus \dots \oplus T_{d-1})$ -computably define sequences of numbers $m_1 < m_2 < \dots$ and sets P_1, P_2, \dots such that $m_0 < m_1$ and each P_s is good above m_s . Now, for each $i < d$, define $S_i \subseteq T_i$ inductively as follows: add σ_i to S_i , and having added $\tau \succeq \sigma_i$ choose the least s such that P_s contains an extension of each direct extension of τ in T_i , and add these extensions to S_i . Then $(S_0, \dots, S_{d-1}) \in \mathcal{S}_\omega(T_0, \dots, T_{d-1})$, and $f(\tau_0, \dots, \tau_{d-1}) = j$ for all $(\tau_0, \dots, \tau_{d-1}) \in \bigcup_n S_0(n) \times \dots \times S_{d-1}(n)$. Clearly, (S_0, \dots, S_{d-1}) is computable from the T_i and the sequences of m_s and P_s , hence from f and the T_i , as desired. \square

In the next section, we will design a good notion of forcing for building infinite strong subtrees, and use this to give more effective proofs of Milliken's tree theorem and its product version. We will need a forest version of the Halpern-Laüchli theorem.

THEOREM 3.5 (Halpern-Laüchli theorem for forests). *Let T_0, \dots, T_{d-1} be infinite trees with no leaves, and $X_0, \dots, X_{d-1} \subseteq \omega^{<\omega}$ be forests such that for each $i < d$, X_i is a strong subforest of T_i of height ω , with common level function. For all $k \geq 1$ and all $f : \bigcup_n T_0(n) \times \dots \times T_{d-1}(n) \rightarrow k$ there exist strong subforests Y_0, \dots, Y_{d-1} of X_0, \dots, X_{d-1} , respectively, with common level function, such that:*

- (1) for each $i < d$, every root of X_i is extended by some root of Y_i ;
- (2) for each $(\sigma_0, \dots, \sigma_{d-1}) \in \text{roots}(X_0) \times \dots \times \text{roots}(X_{d-1})$, f is constant on $\bigcup_n (Y_0 \upharpoonright \sigma_0)(n) \times \dots \times (Y_{d-1} \upharpoonright \sigma_{d-1})(n)$.

In other words, the lemma asserts that no part of any of the forests X_i above any given root is wholly omitted in passing to the subforest Y_i , and the color under f of a tuple in $\bigcup_n Y_0(n) \times \dots \times Y_{d-1}(n)$ depends only on which roots of X_0, \dots, X_{d-1} the elements of the tuple extend.

As with the ordinary Halpern-Laüchli theorem, our interest will be more in an effective version, which we now prove using Theorem 3.4 above.

THEOREM 3.6. *Theorem 3.5 is computably true.*

PROOF. Fix a collection of trees T_0, \dots, T_{d-1} along with strong subforests X_0, \dots, X_{d-1} with a common level function, and a finite coloring $f : \bigcup_n T_0(n) \times \dots \times T_{d-1}(n) \rightarrow k$. For every $i < d$ and $\sigma \in \text{roots}(X_i)$, the set $T_i^\sigma = X_i \upharpoonright \sigma$ is a tree. The result will come from an application of

Theorem 3.4 to the collection of T_i^σ for $i < d$ and $\sigma \in \text{roots}(X_i)$. Define a coloring

$$h : \bigcup_n \prod_{\substack{i < d, \\ \sigma \in \text{roots}(X_i)}} T_i^\sigma(n) \rightarrow k^{|\text{roots}(T_0)| \times \cdots \times |\text{roots}(T_{d-1})|}$$

such that to a tuple $\pi = (\tau_i^\sigma \in T_i^\sigma : i \leq d, \sigma \in \text{roots}(X_i))$, h associates the tuple of all values that f can take on the elements of π . That is,

$$h(\pi) = (f(\tau_0^{\sigma_0}, \dots, \tau_{d-1}^{\sigma_{d-1}}) : (\sigma_0, \dots, \sigma_{d-1}) \in \text{roots}(X_0) \times \cdots \times \text{roots}(X_{d-1})).$$

Note that h is computable from f and the T_i^σ , hence from f , the T_i , and the X_i .

Apply Theorem 3.4 to define a sequence of strong subtrees S_i^σ of T_i^σ , for $i < d$ and $\sigma \in \text{roots}(X_i)$, with a common level function, and computable from h and the T_i^σ . For $i < d$, define $Y_i = \bigcup_{\sigma \in \text{roots}(X_i)} S_i^\sigma$, so that $S_i^\sigma = Y_i \upharpoonright \sigma$. It is clear that each Y_i is a strong subforest of X_i , and that every root of X_i has an extension in Y_i . Moreover, if $(\tau_0, \dots, \tau_{d-1})$ and $(\tau'_0, \dots, \tau'_{d-1})$ both belong to $\bigcup_n S_0^{\sigma_0}(n) \times \cdots \times S_{d-1}^{\sigma_{d-1}}(n)$ for some $(\sigma_0, \dots, \sigma_{d-1}) \in \text{roots}(X_0) \times \cdots \times \text{roots}(X_{d-1})$, then we must have $f(\tau_0, \dots, \tau_{d-1}) = f(\tau'_0, \dots, \tau'_{d-1})$ since h is monochromatic on $\bigcup_n \prod_{i < d, \sigma \in \text{roots}(X_i)} S_i^\sigma(n)$. \square

3.2. Product tree forcing

We now design the main notion of forcing for building strong subtrees. Variants of this notion of forcing will be used throughout the manuscript. Fix a collection of finitely branching trees with no leaves T_0, \dots, T_{d-1} .

DEFINITION 3.7. A *product tree condition* is a tuple

$$(F_0, \dots, F_{d-1}, X_0, \dots, X_{d-1})$$

as follows:

- (1) $(F_0, \dots, F_{d-1}) \in \mathcal{S}_n(T_0, \dots, T_{d-1})$, for some $n \in \mathbb{N}$;
- (2) X_0, \dots, X_{d-1} are infinite strong subforests of T_0, \dots, T_{d-1} , respectively, with a common level function;
- (3) for every $j < d$ and every leaf σ of F_j , say at level k in T_j , $\text{roots}(X_j)$ is $(k+1)$ - σ -dense in T_j .

Thus, the last condition asserts that every node $\tau \in T_j(k+1)$ extending σ has an extension in $\text{roots}(X_j)$.

For instance, let $d = 1$ and $T_0 = 2^{<\omega}$, with $F_0 = \{01, 01001, 01100\}$ and X_0 any strong subforest of $2^{<\omega}$ with $\text{roots}(X_0) = \{0100100110, 0100110101, 0110000010, 0110011100\}$. Then (F_0, X_0) is a product tree condition. The leaves of F_0 are 01001 and 01100 and are at level 5 in $2^{<\omega}$. The roots 0100100110 and 0100110101 of X_0 witness $(5+1)$ - σ -density of $\text{roots}(X_0)$ for $\sigma = 01001$, since the extensions of σ at level 6 in $2^{<\omega}$ are 010010 and 010011.

DEFINITION 3.8. A product tree condition

$$d = (\hat{F}_0, \dots, \hat{F}_{d-1}, \hat{X}_0, \dots, \hat{X}_{d-1})$$

extends $c = (F_0, \dots, F_{d-1}, X_0, \dots, X_{d-1})$, written $d \leq c$, if for every $j < d$, $F_j \subseteq \hat{F}_j$, $X_j \subseteq \hat{X}_j$ and $\hat{F}_j \setminus F_j \subseteq X_j$.

REMARK 3.9. Given a product tree condition

$$c = (F_0, \dots, F_{d-1}, X_0, \dots, X_{d-1}),$$

it is not necessarily the case that $F_0 \cup X_0, \dots, F_{d-1} \cup X_{d-1}$ are strong subtrees of T_0, \dots, T_{d-1} , respectively, as witnessed by the same level function. Indeed, the forests may have extra roots unrelated to the finite trees. However, by removing some roots of the forests, one can always obtain an extension $d = (F_0, \dots, F_{d-1}, Y_0, \dots, Y_{d-1})$ for which it is the case. We can therefore assume this when convenient. However, in the proof of strong cone avoidance of the Halpern-Lauchli theorem (Theorem 3.21), we will use the degree of freedom of being able to have extra roots for the construction of multiple product tree conditions all sharing the same forests.

We now define a forcing relation for product tree conditions. We follow a standard approach to forcing in arithmetic, using strong forcing; see, e.g., Shore [39, Chapter 3] for a complete introduction. We use \Vdash (“forces”) for the forcing relation irrespective of the underlying forcing notion, as no confusion will arise in our treatment. As is usual, we write $\not\Vdash$ (“ \dots does not force \dots ”) as an abbreviation $\neg(\dots \Vdash \dots)$. Throughout, we work in the language of second-order arithmetic. We follow the usual convention that for a $\Delta_0^{0,Z}$ formula $\varphi(G)$ with a free set parameter G , if $\varphi(F)$ holds for a finite set F , then so does $\varphi(F \cup E)$ for every finite set E such that $\min E \setminus F > \max F$. We also assume our pairing function is such that if $\sigma, \tau \in \omega^{<\omega}$ and $|\tau| > |\sigma|$ then the code for τ is larger than the code for σ . So for example, if F is viewed as a subset of Baire and the length of $\tau \in \omega^{<\omega}$ is larger than the length of every string in F , then the code of τ is larger than $\max F$. In particular, if every string in $E \setminus F$ is longer than every string in F and $\varphi(F)$ holds then so does $\varphi(F \cup E)$.

DEFINITION 3.10. Let $c = (F_0, \dots, F_{d-1}, X_0, \dots, X_{d-1})$ be a product tree condition, $Z \subseteq \mathbb{N}$ a set, and $\varphi(G_0, \dots, G_{d-1}, x)$ a $\Delta_0^{0,Z}$ formula with a free set parameters G_0, \dots, G_{d-1} and a free integer parameter x .

- (1) $c \Vdash (\exists x)\varphi(G_0, \dots, G_{d-1}, x)$ if $\varphi(F_0, \dots, F_{d-1}, x)$ holds for some $x \in \mathbb{N}$.
- (2) $c \Vdash (\forall x)\varphi(G_0, \dots, G_{d-1}, x)$ if $\varphi(F_0 \cup E_0, \dots, F_{d-1} \cup E_{d-1}, x)$ holds for all $x \in \mathbb{N}$ and all finite subsets E_0, \dots, E_{d-1} of X_0, \dots, X_{d-1} , respectively, such that $F_0 \cup E_0, \dots, F_{d-1} \cup E_{d-1}$ are finite strong subtrees of T_0, \dots, T_{d-1} , respectively, with a common level function.

Of course, Item 2 should abstractly be defined as there being no d extending c such that $d \Vdash (\exists x)\varphi(G_0, \dots, G_{d-1}, x)$, but this is easily seen to be equivalent

to the given formulation. We give it explicitly in the definition since we will make frequent use of it.

Every filter \mathcal{U} on the set of product tree conditions induces a d -tuple of (finite or infinite) strong subtrees $G_0^{\mathcal{U}}, \dots, G_{d-1}^{\mathcal{U}}$ of T_0, \dots, T_{d-1} , respectively, with common level function. Moreover, if $c \Vdash (\exists x)\varphi(G_0, \dots, G_{d-1}, x)$ or $c \Vdash (\forall x)\varphi(G_0, \dots, G_{d-1}, x)$ for some condition $c \in \mathcal{U}$ and $\Delta_0^{0,Z}$ formula φ , then $(\exists x)\varphi(G_0^{\mathcal{U}}, \dots, G_{d-1}^{\mathcal{U}}, x)$ holds or $(\forall x)\varphi(G_0^{\mathcal{U}}, \dots, G_{d-1}^{\mathcal{U}}, x)$ holds, respectively.

Given a Turing functional Γ , sets $C, Z \subseteq \mathbb{N}$, and a condition c , we write $c \Vdash \Gamma^{G_0 \oplus \dots \oplus G_{d-1} \oplus Z} \neq C$ if there is an $x \in \mathbb{N}$ such that either $c \Vdash \Gamma^{G_0 \oplus \dots \oplus G_{d-1} \oplus Z}(x) \uparrow$ or $c \Vdash \Gamma^{G_0 \oplus \dots \oplus G_{d-1} \oplus Z}(x) \downarrow \neq C(x)$. (Note that $C(x)$ is a definite value, so C is not a parameter in the latter formula.) The following lemma states that given a filter \mathcal{U} on the set of product tree conditions, if for every Turing functional Γ there is a condition $c \in \mathcal{U}$ such that $c \Vdash \Gamma^{G_0 \oplus \dots \oplus G_{d-1} \oplus Z} \neq C$, then $G_0^{\mathcal{U}}, \dots, G_{d-1}^{\mathcal{U}}$ are all infinite.

LEMMA 3.11. *For every $n \in \mathbb{N}$, and all sets $C, Z \subseteq \mathbb{N}$, there is a Turing functional Γ such that if $c = (F_0, \dots, F_{d-1}, X_0, \dots, X_{d-1})$ is any product tree condition satisfying*

$$c \Vdash \Gamma^{G_0 \oplus \dots \oplus G_{d-1} \oplus Z} \neq C$$

then F_0, \dots, F_{d-1} all have height at least n .

PROOF. Let Γ be the Turing functional such that for all sets F_0, \dots, F_{d-1} coding strong subtrees, if the height of each F_j is not at least n then $\Gamma^{F_0 \oplus \dots \oplus F_{d-1} \oplus Z}(x) \uparrow$ for all $x \in \mathbb{N}$ and $Z \subseteq \mathbb{N}$, and otherwise

$$c \Vdash \Gamma^{G_0 \oplus \dots \oplus G_{d-1} \oplus Z}(x) \downarrow = 0$$

for all x and Z .

Now suppose $c \Vdash \Gamma^{G_0 \oplus \dots \oplus G_{d-1} \oplus Z} \neq C$. If $c \Vdash \Gamma^{G_0 \oplus \dots \oplus G_{d-1} \oplus Z}(x) \downarrow \neq C(x)$ for some $x \in \mathbb{N}$, then by Definition 3.10(1), $\Gamma^{F_0 \oplus \dots \oplus F_{d-1} \oplus Z}(x) \downarrow \neq C(x)$, so by choice of Γ , F_0, \dots, F_{d-1} must all have height at least n .

If $c \Vdash \Gamma^{G_0 \oplus \dots \oplus G_{d-1} \oplus Z}(x) \uparrow$ for some $x \in \mathbb{N}$, then by Definition 3.10(2),

$$\Gamma^{(F_0 \cup E_0) \oplus \dots \oplus (F_{d-1} \cup E_{d-1}) \oplus Z}(x) \uparrow$$

for all finite subsets E_0, \dots, E_{d-1} of X_0, \dots, X_{d-1} , respectively, such that $F_0 \cup E_0, \dots, F_{d-1} \cup E_{d-1}$ are finite strong subtrees of T_0, \dots, T_{d-1} with a common level function. But since X_0, \dots, X_{d-1} are infinite, we can find some such E_0, \dots, E_{d-1} with $F_0 \cup E_0, \dots, F_{d-1} \cup E_{d-1}$ all of height at least n , contradicting the definition of Γ . \square

REMARK 3.12. The definition of product tree condition is made with respect to our particular choice of trees T_0, \dots, T_{d-1} . We will always work with a single such choice at any given time, and so do not decorate our conditions by these trees explicitly. In particular, when a product tree condition is mentioned it should be understood as being with respect to whichever trees T_0, \dots, T_{d-1} are currently under discussion.

3.3. Strong cone avoidance of MTT^1

Before proving strong cone avoidance of the product version of Milliken's tree theorem, we prove a similar result for its non-product version. The proof is simpler and is actually sufficient to prove cone avoidance of the non-product version of Milliken's tree theorem for height 2. The techniques involved are a variation of the notion of *k-hierarchy* of Chong et al [7, Section 4]. The theorem proven in this section will not be used in the remainder of the monograph, but can be seen as an instructive warm-up to the proof of Theorem 3.21.

THEOREM 3.13. MTT^1 *admits strong cone avoidance.*

In what follows, fix two sets $C, Z \subseteq \mathbb{N}$ such that $C \not\leq_T Z$. Also fix an infinite Z -computable Z -computably bounded tree T with no leaves and an arbitrary 2-partition $A_0 \sqcup A_1 = T$ representing an instance of MTT_2^1 . Our task is to exhibit an MTT^1 -solution to whose join with Z still does not compute C .

Given a finite strong subtree F of T , a *cover* of F is a set $E \subseteq T$ such that for every leaf σ of F , every immediate extension of σ in T has an extension in E .

DEFINITION 3.14.

- (1) A *tree condition* is a pair (F, X) such that F is a finite strong subtree of T , X is an infinite strong subforest of T , and $\text{roots}(X)$ is a cover of F .
- (2) A tree condition (\hat{F}, \hat{X}) *extends* (F, X) , written $(\hat{F}, \hat{X}) \leq (F, X)$, if $F \subseteq \hat{F}$, $\hat{X} \subseteq X$ and $\hat{F} \setminus F \subseteq X$.
- (3) (F, X) is *cone avoiding* if $C \not\leq_T X \oplus Z$.

Note that a tree condition is nothing but a product tree condition (Definition 3.7) relative to the 1-tuple T .

A tree condition inherits the forcing relation from the one for product tree conditions (Definition 3.10).

DEFINITION 3.15. Let (F, X) be a tree condition and $\varphi(G, x)$ a $\Delta_0^{0,Z}$ formula with a free set parameter G and a free integer parameter x .

1. $(F, X) \Vdash (\exists x)\varphi(G, x)$ if $\varphi(F, x)$ holds for some $x \in \mathbb{N}$.
2. $(F, X) \Vdash (\forall x)\varphi(G, x)$ if $\varphi(F \cup E, x)$ holds for all $x \in \mathbb{N}$ and all finite $E \subseteq X$ such that $F \cup E$ is a finite strong subtree of T .

Every filter \mathcal{U} on the set of tree conditions induces a (finite or infinite) strong subtree $G_{\mathcal{U}}$ of T . Moreover, if $(F, X) \Vdash (\exists x)\varphi(G, x)$ or $(F, X) \Vdash (\forall x)\varphi(G, x)$ for some tree condition $(F, X) \in \mathcal{U}$ and $\Delta_0^{0,Z}$ formula φ , then $(\exists x)\varphi(G_{\mathcal{U}}, x)$ or $(\forall x)\varphi(G_{\mathcal{U}}, x)$ holds, respectively.

Given a Turing functional Γ , we write $(F, X) \Vdash \Gamma^{G \oplus Z} \neq C$ if there is an $x \in \mathbb{N}$ such that either $(F, X) \Vdash \Gamma^{G \oplus Z}(x) \uparrow$ or $(F, X) \Vdash \Gamma^{G \oplus Z}(x) \downarrow \neq C(x)$. We have the following analogue of Lemma 3.11, which is proved in the same way.

LEMMA 3.16. *For every $n \in \mathbb{N}$, there is a Turing functional Γ such that for every tree condition (F, X) , if $(F, X) \Vdash \Gamma^{G \oplus Z} \neq C$ then F has height at least n .*

DEFINITION 3.17. A *compound tree condition* is a tuple (F, \mathcal{F}, X) such that (F, X) is a tree condition with $F \subseteq A_0$, and \mathcal{F} is a finite collection of finite sets as follows:

- (1) for every $E \in \mathcal{F}$, (E, X) is a tree condition with $E \subseteq A_1$;
- (2) $\bigcup_{E \in \mathcal{F}} \text{roots}(E)$ is a cover of F .

A compound tree condition (F, \mathcal{F}, X) is *cone avoiding* if $C \not\leq_{\text{T}} X \oplus Z$.

Equivalently, (F, \mathcal{F}, X) is cone avoiding if (F, X) is cone avoiding as a tree condition, and so is (E, X) for every $E \in \mathcal{F}$. Note that we do not require the finite strong subtrees in \mathcal{F} to be witnessed by the same level function.

LEMMA 3.18.

1. *For every tree condition (F, X) with $F \subseteq A_0$, and every level $\ell \in \mathbb{N}$ such that $X(\ell) \cap A_1$ is a cover of F , (F, \mathcal{F}, Y) is a compound tree condition, where $\mathcal{F} = \{\{\rho\} : \rho \in X(\ell) \cap A_1\}$ and $Y = X \setminus \bigcup_{s \leq \ell} X(s)$.*
2. *For every compound tree condition (F, \mathcal{F}, X) , every $E \in \mathcal{F}$, and every extension $(\hat{E}, \hat{X}) \leq (E, X)$ with $\hat{E} \setminus E \subseteq A_1$ and such that every root of X is extended by a root of \hat{X} , $(F, \hat{\mathcal{F}}, \hat{X})$ is a compound tree condition, where $\hat{\mathcal{F}} = \{\hat{E}\} \cup (\mathcal{F} \setminus \{E\})$.*

PROOF. Immediate from the definitions. \square

LEMMA 3.19. *Suppose there is no infinite strong perfect subtree $S \subseteq T$ such that $S \subseteq A_0$ and $C \not\leq_{\text{T}} S \oplus Z$. Then for every cone avoiding tree condition (F, X) , there is a level $\ell \in \mathbb{N}$ such that $X(\ell) \cap A_1$ is a cover of F .*

PROOF. Suppose first there is some level ℓ such that every root ρ of X has an extension $\sigma \in X(\ell) \cap A_1$. Since $\text{roots}(X)$ is a cover of F , then so is $X(\ell) \cap A_1$.

So now suppose that for every level ℓ , there is some root ρ of X all of whose extensions $\sigma \in X(\ell)$ belong to A_0 . We claim there is an infinite strong subtree $S \subseteq T$ such that $S \subseteq A_0$ and $C \not\leq_{\text{T}} S \oplus Z$, contrary to the hypothesis of the lemma. Let $f : \mathbb{N} \rightarrow \text{roots}(X)$ be the function which to ℓ associates such a root ρ . By strong cone avoidance of RT_2^1 ([14], Lemma 3.2), there is an infinite set of levels H which is f -homogeneous for some root ρ of X and such that $C \not\leq_{\text{T}} H \oplus X \oplus Z$. In particular, for every level $\ell \in H$ and every node σ at level ℓ in X extending ρ we have $\sigma \in A_0$. But now we can $H \oplus X$ -computably build an infinite strong subtree $S \subseteq T$ among these σ . Then $S \subseteq A_0$, and since $S \leq_{\text{T}} H \oplus X$ we also have $C \not\leq_{\text{T}} S \oplus Z$. \square

LEMMA 3.20. *For every cone avoiding compound tree condition (F, \mathcal{F}, X) and every tuple of Turing functionals $(\Gamma_F, \Gamma_E : E \in \mathcal{F})$, one of the following holds:*

1. *There is a cone avoiding extension $(\hat{F}, \hat{X}) \leq (F, X)$ such that $(\hat{F}, \hat{X}) \Vdash \Gamma_F^{G \oplus Z} \neq C$ and $\hat{F} \setminus F \subseteq A_0$;*
2. *There is a cone avoiding extension $(\hat{E}, \hat{X}) \leq (E, X)$ for some $E \in \mathcal{F}$ such that $(\hat{E}, \hat{X}) \Vdash \Gamma_E^{G \oplus Z} \neq C$ and $\hat{E} \setminus E \subseteq A_1$ and every root of X is extended by a root of \hat{X} .*

PROOF. Let W be the set of pairs $(x, v) \in \mathbb{N} \times \{0, 1\}$ such that for every 2-partition $B_0 \sqcup B_1 = X$ one of the following holds:

- (a) there is a finite set $H \subseteq X \cap B_0$ such that $F \cup H$ is a finite strong subtree of T and $\Gamma_F^{(F \cup H) \oplus Z}(x) \downarrow = v$;
- (b) there is some $E \in \mathcal{F}$ and a finite set $H_E \subseteq X \cap B_1$ such that $E \cup H_E$ is a finite strong subtree of T and $\Gamma_E^{(E \cup H_E) \oplus Z}(x) \downarrow = v$.

By compactness, the set W is $X \oplus Z$ -c.e. There are three cases:

Case 1: $(x, 1 - C(x)) \in W$ for some $x \in \mathbb{N}$. Let $B_0 = X \cap A_0$ and $B_1 = X \cap A_1$. If (a) holds with witness H , then let ℓ be the level of the leaves of $F \cup H$ in X , and $\hat{X} = X \setminus \bigcup_{s \leq \ell} X(s)$. Now $(F \cup H, \hat{X})$ is a tree condition satisfying item 1 of the lemma. If (b) holds for some $E \in \mathcal{F}$ with witness H_E , then let ℓ be the level of the leaves of $E \cup H_E$ in X , and $\hat{X} = X \setminus \bigcup_{s \leq \ell} X(s)$. Now $(E \cup H_E, \hat{X})$ is a tree condition satisfying item 2 of the lemma.

Case 2: $(x, C(x)) \notin W$ for some $x \in \mathbb{N}$. Let \mathcal{C} be the $\Pi_1^{0, X \oplus Z}$ class of all sets $B_0 \oplus B_1$ such that $B_0 \sqcup B_1 = X$ and neither (a) nor (b) holds for the pair $(x, C(x))$. By assumption, $\mathcal{C} \neq \emptyset$. By the cone avoidance basis theorem ([24], Corollary 2.11), there is a $B_0 \oplus B_1 \in \mathcal{C}$ such that $C \not\leq_T B_0 \oplus B_1 \oplus X \oplus Z$. For $\sigma \in X$, write $B_i(\sigma)$ for the unique $i < 2$ such that $\sigma \in B_i$. Let $I = \text{roots}(X)$. By Theorem 3.4 applied to the finite I -tuple of infinite trees $(X \upharpoonright \rho : \rho \in I)$ and the coloring g defined on $\bigcup_n \prod_{\rho \in I} (X \upharpoonright \rho)(n)$ by $g(\sigma_\rho : \rho \in I) = (B(\sigma_\rho) : \rho \in I)$, there is a $B_0 \oplus B_1 \oplus X$ -computable finite tuple of infinite strong subtrees $(Y_\rho : \rho \in I)$ of $(X \upharpoonright \rho : \rho \in I)$ with common level function, together with a tuple of colors $(i_\rho \in \{0, 1\} : \rho \in I)$ such that $Y_\rho \subseteq B_{i_\rho}$ for every $\rho \in I$. For every $E \in \mathcal{F}$, let I_E be the set of nodes in I extending the root of E . By assumption, I_E is a cover of E .

If $I_E \subseteq \{\rho \in I : i_\rho = 1\}$ for some $E \in \mathcal{F}$, then $(E, \bigcup_{\rho \in I} Y_\rho)$ is a cone avoiding extension of (E, X) such that every root of X is extended by a root of $\bigcup_{\rho \in I} Y_\rho$, and forcing $\Gamma_E^{G \oplus Z}(x) \uparrow$ or $\Gamma_E^{G \oplus Z}(x) \downarrow \neq C(x)$.

If $I_E \cap \{\rho \in I : i_\rho = 0\} \neq \emptyset$ for every $E \in \mathcal{F}$, then in particular, every root of every $E \in \mathcal{F}$ has an extension in $\{\rho \in I : i_\rho = 0\}$. Since the set of roots of the trees in E form a cover of F , then $\{\rho \in I : i_\rho = 0\}$ is a cover of F . Thus, $(F, \bigcup_{i_\rho=0} Y_\rho)$ is a cone avoiding extension of (F, X) forcing $\Gamma_F^{G \oplus Z}(x) \uparrow$ or $\Gamma_F^{G \oplus Z}(x) \downarrow \neq C(x)$.

Case 3: *otherwise.* Then for $x, y \in \mathbb{N}$ we have $(x, y) \in W$ if and only if $y = C(x)$. But as W is $X \oplus Z$ -c.e., this implies that $C \leq_T X \oplus Z$, which is a contradiction. \square

We are now ready to prove strong cone avoidance of Milliken's tree theorem for height 1.

PROOF OF THEOREM 3.13. Suppose first there is a filter \mathcal{U} of cone avoiding tree conditions such that $F \subseteq A_0$ for every $(F, X) \in \mathcal{U}$, and such that for every Turing functional Γ there is a tree condition $(F, X) \in \mathcal{U}$ with $(F, X) \Vdash \Gamma^{G \oplus Z} \neq C$. Then by definition of a tree condition, $G_{\mathcal{U}}$ is a strong subtree of T . Moreover, by assumption, $G_{\mathcal{U}} \subseteq A_0$ and $C \not\leq_T G_{\mathcal{U}} \oplus Z$. Last, by Lemma 3.16, $G_{\mathcal{U}}$ is infinite, thus $G_{\mathcal{U}}$ satisfies the statement of the theorem.

Suppose now there is no such filter. Then there is a cone avoiding tree condition (F, X) such that $F \subseteq A_0$ and a Turing functional Γ_F such that for every cone avoiding extension (\hat{F}, \hat{X}) with $\hat{F} \setminus F \subseteq A_0$ we have $(\hat{F}, \hat{X}) \not\Vdash \Gamma_F^{G \oplus Z} \neq C$.

Assume there is no infinite strong subtree $S \subseteq T$ such that $S \subseteq A_0$ and $C \not\leq_T S \oplus Z$, otherwise we are done. By Lemma 3.19, there is a level $\ell \in \mathbb{N}$ such that $X(\ell) \cap A_1$ is a cover of F . Let $I = X(\ell) \cap A_1$.

We claim there exists an infinite sequence of cone avoiding compound tree conditions

$$(F, \mathcal{F}_0, X_0), (F, \mathcal{F}_1, X_1), \dots$$

such that for every $s \in \mathbb{N}$, letting $s = (\Gamma_\rho : \rho \in I)$, the following holds:

- (1) $\mathcal{F}_s = \{E_{s,\rho} : \rho \in I\}$;
- (2) $X_s \subseteq X$;
- (3) $\mathcal{F}_{s+1} \setminus \{E_{s+1,\rho}\} = \mathcal{F}_s \setminus \{E_{s,\rho}\}$ for some $\rho \in I$ with $(E_{s+1,\rho}, X_{s+1}) \leq (E_{s,\rho}, X_s)$ and $(E_{s+1,\rho}, X_{s+1}) \Vdash \Gamma_\rho^{G \oplus Z} \neq C$.

By Lemma 3.18(1), letting $\mathcal{F}_0 = \{\{\rho\} : \rho \in I\}$ and $X_0 = X \setminus \bigcup_{t \leq \ell} X(t)$, the tuple (F, \mathcal{F}_0, X_0) is a cone avoiding compound tree condition. Given a compound tree condition (F, \mathcal{F}_s, X_s) and letting $s = (\Gamma_\rho : \rho \in I)$, by Lemma 3.20, either there is a cone avoiding extension $(\hat{F}, \hat{X}) \leq (F, X)$ such that $(\hat{F}, \hat{X}) \Vdash \Gamma_F^{G \oplus Z} \neq C$ and $\hat{F} \setminus F \subseteq A_0$, or there some $\rho \in I$ and a cone avoiding extension $(E_{s+1,\rho}, X_{s+1}) \leq (E_{s,\rho}, X_s)$ such that $(E_{s+1,\rho}, X_{s+1}) \Vdash \Gamma_\rho^{G \oplus Z} \neq C$ and $E_{s+1,\rho} \setminus E_{s,\rho} \subseteq A_1$ and every root of X_s extends in a root of X_{s+1} . The former case cannot happen, so the latter case holds, and we can define $(F, \mathcal{F}_{s+1}, X_{s+1})$ accordingly by Lemma 3.18(2). This proves our claim.

By a pairing argument, there is a $\rho \in I$ such that for every Turing functional Γ there is an $s \in \mathbb{N}$ such that $(E_{s,\rho}, X_s) \Vdash \Gamma^{G \oplus Z} \neq C$. By construction, the conditions $(E_{s,\rho}, X_s)$ for this fixed ρ are compatible for all s . Thus, we can fix a filter \mathcal{U} containing all of them. Again, by definition of a tree condition, $G_{\mathcal{U}}$ is a strong subtree of T . By assumption, $G_{\mathcal{U}} \subseteq A_1$ and

$C \not\leq_T G_{\mathcal{U}} \oplus Z$. Last, by Lemma 3.16, $G_{\mathcal{U}}$ is infinite, thus $G_{\mathcal{U}}$ satisfies the statement of the theorem. This completes the proof of Theorem 3.13. \square

3.4. Strong cone avoidance of the Halpern-Laüchli theorem

We now prove that the Halpern-Laüchli theorem admits strong cone avoidance. This will be used in multiple parts of the rest of the manuscript, to prove that the product version of Milliken's tree theorem for height 2 admits cone avoidance (Theorem 3.21) and hence does not imply ACA_0 over RCA_0 , and also to prove the same for the product version of Milliken's tree theorem for height 3, but where at most 2 colors are allowed in the solution (Theorem 4.28).

THEOREM 3.21. *The Halpern-Laüchli theorem admits strong cone avoidance.*

The meta-analysis of a theorem sometimes requires the use of the classical version of the theorem itself. In order to prove Theorem 3.21, we need the following version of the Halpern-Laüchli theorem:

THEOREM 3.22. *Let T_0, \dots, T_{d-1} be infinite trees with no leaves. For all $k \geq 1$, there is an $N \in \mathbb{N}$ such that for every $f : T_0(N) \times \dots \times T_{d-1}(N) \rightarrow k$ there is an $\ell < N$, a $\pi \in T_0(\ell) \times \dots \times T_{d-1}(\ell)$, and an $(\ell + 1)$ - π -dense matrix $P \subseteq T_0(N) \times \dots \times T_{d-1}(N)$ on which f is constant.*

PROOF. Fix k . The Halpern-Laüchli theorem (Theorem 2.28) implies that for every k -coloring of $\bigcup_n T_0(n) \times \dots \times T_{d-1}(n)$ there exists an $N \in \mathbb{N}$ and a tuple of strong subtrees $(S_0, \dots, S_{d-1}) \in \mathcal{S}_2(T_0, \dots, T_{d-1})$ with level function bounded by N such that f is constant on $\bigcup_{n < 2} S_0(n) \times \dots \times S_{d-1}(n)$. By compactness of the space of k -colorings of $\bigcup_n T_0(n) \times \dots \times T_{d-1}(n)$, we can choose a single such N that works for all k -colorings: that is, for every k -coloring, the trees S_0, \dots, S_{d-1} can be taken as strong subtrees of $\bigcup_{n < N} T_0(n), \dots, \bigcup_{n < N} T_{d-1}(n)$, respectively. The claim is that this N also witnesses the theorem.

Let $f : T_0(N) \times \dots \times T_{d-1}(N) \rightarrow k$ be a coloring. For any $i < d$, $n \in \mathbb{N}$ and $\sigma \in T_i(n)$, let $e(\sigma)$ be any element of $T_i(N)$ compatible with σ : either an extension, or a prefix. Define the coloring $g : \bigcup_n T_0(n) \times \dots \times T_{d-1}(n) \rightarrow k$ by $g(\sigma_0, \dots, \sigma_{d-1}) = f(e(\sigma_0), \dots, e(\sigma_{d-1}))$ for all $(\sigma_0, \dots, \sigma_{d-1})$. By choice of N , we can find $(S_0, \dots, S_{d-1}) \in \mathcal{S}_2(T_0, \dots, T_{d-1})$ with level function bounded by N so that g is constant on $S_0(1) \times \dots \times S_{d-1}(1)$. Thus, f is constant on $P = e(S_0(1)) \times \dots \times e(S_{d-1}(1))$. Moreover, if we let ℓ be the (common) first level of the S_i in T_i , and let π be the unique element of $S_0(0) \times \dots \times S_{d-1}(0)$, then P is an $(\ell + 1)$ - π -dense matrix. \square

In what follows, fix two sets C and Z such that $C \not\leq_T Z$. Also fix a tuple of infinite Z -computable Z -computably bounded trees with no leaves T_0, \dots, T_{d-1} and an arbitrary k -partition $A_0 \sqcup \dots \sqcup A_{k-1} = \bigcup_n T_0(n) \times \dots \times T_{d-1}(n)$ representing an instance of the Halpern-Laüchli theorem (for k -colorings).

For this section, we will need to strengthen the extension relation for product tree conditions (relative to these T_i).

DEFINITION 3.23. Let T_0, \dots, T_{d-1} be infinite trees with no leaves. A product tree condition $d = (\hat{F}_0, \dots, \hat{F}_{d-1}, \hat{X}_0, \dots, \hat{X}_{d-1})$ (relative to these T_i) extends $c = (F_0, \dots, F_{d-1}, X_0, \dots, X_{d-1})$, written $d \leq c$, if for every $j < d$, $F_j \subseteq \hat{F}_j$, $\hat{X}_j \subseteq X_j$ and $\hat{F}_j \setminus F_j \subseteq X_j$, and moreover, every root of X_j is extended by a root of \hat{X}_j .

DEFINITION 3.24. A product tree condition $(F_0, \dots, F_{d-1}, X_0, \dots, X_{d-1})$ is *cone avoiding* if $C \not\leq_T X_0 \oplus \dots \oplus X_{d-1} \oplus Z$. It is *level-homogeneous* if for every n , there is some color $i < k$ such that $F_0(n) \times \dots \times F_{d-1}(n) \subseteq A_i$.

In particular, if d extends c in the sense of Definition 3.23, then d extends c in the sense of Definition 3.8.

Any product tree condition of the form

$$(\{\rho_0\}, \dots, \{\rho_{d-1}\}, X_0, \dots, X_{d-1})$$

is level-homogeneous. Let \mathbb{P} be the set of cone avoiding level-homogeneous product tree conditions, ordered by the stronger relation of Definition 3.23. The following lemma is the core of the argument. The proof of Lemma 3.25 shows that the witnessed condition c can actually be chosen so that its stems are singletons.

LEMMA 3.25. *There is a condition $c \in \mathbb{P}$ such that for every Turing functional Γ , the set of conditions $c' \in \mathbb{P}$ satisfying $c' \Vdash \Gamma^{G_0 \oplus \dots \oplus G_{d-1} \oplus Z} \neq C$ is \mathbb{P} -dense below c .*

PROOF. Assume for the sake of contradiction that for every condition $c \in \mathbb{P}$, there is a Turing functional Γ and a \mathbb{P} -extension, every further \mathbb{P} -extension c' of which satisfies $c' \not\Vdash \Gamma^{G_0 \oplus \dots \oplus G_{d-1} \oplus Z} \neq C$.

We build non-effectively a d -tuple of subsets S_0, \dots, S_{d-1} of T_0, \dots, T_{d-1} , respectively. Formally, these sets will not be trees, as specified in Definition 2.16, since they will not be closed under \wedge . However, the prefix relation induces a tree structure, and seen as such, the S_j will be finitely branching trees with no leaves. (In fact, the S_j will have a common level function.) We may thus use Remark 2.18 to think of the S_j as trees, and in particular, we may apply Theorem 3.22 to them.

Along with S_0, \dots, S_{d-1} , we define the following functions:

- (1) $\text{sets} : \mathbb{N} \rightarrow \mathcal{P}(\omega^{<\omega}) \times \dots \times \mathcal{P}(\omega^{<\omega})$ which to a level $\ell \in \mathbb{N}$ associates a d -tuple X_0, \dots, X_{d-1} of infinite strong subforests of T_0, \dots, T_{d-1} , respectively, with a common level function, such that $C \not\leq_T X_0 \oplus \dots \oplus X_{d-1} \oplus Z$ and for every $j < d$, $S_j(\ell + 1) = \text{roots}(X_j)$;
- (2) $\text{stems} : \bigcup_n S_0(n) \times \dots \times S_{d-1}(n) \rightarrow \mathcal{S}_{<\omega}(T_0, \dots, T_{d-1})$, which to a $\pi \in S_0(\ell) \times \dots \times S_{d-1}(\ell)$ associates a tuple (F_0, \dots, F_{d-1}) whose roots pointwise extend π , and such that $(F_0, \dots, F_{d-1}, \text{sets}(\ell))$ is a \mathbb{P} -condition;

- (3) $\text{req} : \bigcup_n S_0(n) \times \cdots \times S_{d-1}(n) \rightarrow \mathbb{N}$, which to a $\pi \in S_0(\ell) \times \cdots \times S_{d-1}(\ell)$ associates the index $e \in \mathbb{N}$ of a Turing functional Φ_e such that for every \mathbb{P} -extension c' of the condition $(\text{stems}(\pi), \text{sets}(\ell))$, $c' \not\Vdash \Gamma_e^{G_0 \oplus \cdots \oplus G_{d-1} \oplus Z} \neq C$.

Moreover, we ensure that for every level $\ell \in \mathbb{N}$, $\text{sets}(\ell+1)$ is a tuple of strong subforests of $\text{sets}(\ell)$ with common level function.

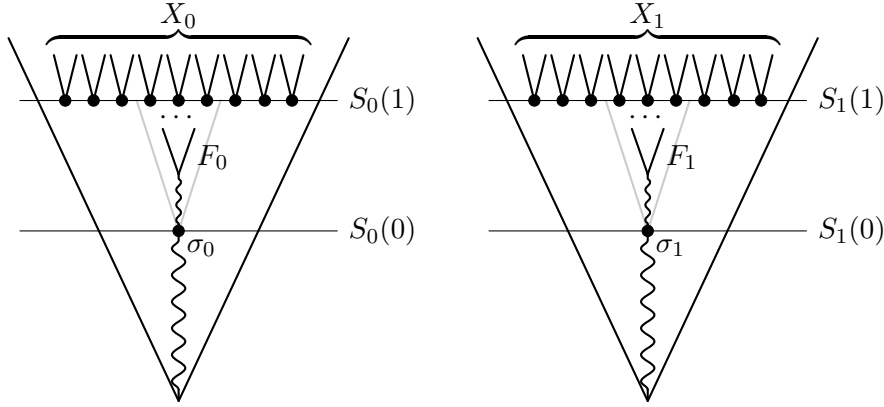

FIGURE 3.1. A representation of the construction of S_0, S_1 , and the functions sets and stems . If $\pi = (\sigma_0, \sigma_1)$, then $\text{stems}(\pi) = (F_0, F_1)$ and $\text{sets}(1) = (X_0, X_1)$.

Construction. We define S_0, \dots, S_{d-1} and the functions sets , stems and req level by level. For convenience of notation, let $\text{sets}(-1) = (T_0, \dots, T_{d-1})$. At level $\ell \geq 0$, assume $\text{sets}(\ell-1)$ is already defined. Say $(Y_0, \dots, Y_{d-1}) = \text{sets}(\ell-1)$. For every $j < d$, let $S_j(\ell) = \text{roots}(Y_j)$. Now let π_0, \dots, π_{r-1} be a finite listing of all the elements in $S_0(\ell) \times \cdots \times S_{d-1}(\ell)$. We define $\text{stems}(\pi_s)$ and $\text{req}(\pi_s)$ successively for each $s < r$, together with a decreasing sequence of d -tuples of cone avoiding strong subforests

$$(X_0^0, \dots, X_{d-1}^0), \dots, (X_0^r, \dots, X_{d-1}^r).$$

Then $\text{sets}(\ell) = (X_0^r, \dots, X_{d-1}^r)$. Initially, let $(X_0^0, \dots, X_{d-1}^0)$ be the tuple $(Y_0 \setminus Y_0(0), \dots, Y_{d-1} \setminus Y_{d-1}(0))$. At stage $s < r$, assume $(X_0^s, \dots, X_{d-1}^s)$ is defined. Say $\pi_s = (\rho_0, \dots, \rho_{d-1})$. In particular,

$$(\{\rho_0\}, \dots, \{\rho_{d-1}\}, X_0^s, \dots, X_{d-1}^s)$$

is a \mathbb{P} -condition. By assumption, this has a \mathbb{P} -extension $(F_0, \dots, F_{d-1}, X_0^{s+1}, \dots, X_{d-1}^{s+1})$ for which there is a Turing functional Φ_e such that every further \mathbb{P} -extension c' satisfies $c' \not\Vdash \Gamma_e^{G_0 \oplus \cdots \oplus G_{d-1} \oplus Z} \neq C$. So we have $(X_0^{s+1},$

\dots, X_{d-1}^{s+1}), and we set $\text{stems}(\pi_s) = (F_0, \dots, F_{d-1})$ and $\text{req}(\pi_s) = e$. Now if $s < r - 1$, proceed to $s + 1$. This finishes the construction. (See Figure 3.1.)

Verification.

CLAIM 3.26. *For every $\ell_0 < \ell_1$ and every $\pi \in S_0(\ell_0) \times \dots \times S_{d-1}(\ell_0)$, the tuple $(\text{stems}(\pi), \text{sets}(\ell_1))$ is a \mathbb{P} -extension of $(\text{stems}(\pi), \text{sets}(\ell_0))$.*

PROOF. Say $\text{sets}(\ell_0) = (X_0, \dots, X_{d-1})$ and $\text{sets}(\ell_1) = (Y_0, \dots, Y_{d-1})$. By an immediate induction, $\text{sets}(\ell_1)$ is a tuple of strong subforests of $\text{sets}(\ell_0)$ with common level function. By construction, for all $j < d$ we have $S_j(\ell_0 + 1) = \text{roots}(X_j)$ and $S_j(\ell_1 + 1) = \text{roots}(Y_j)$, and since we are dealing with extension in \mathbb{P} here, this implies that every root of X_j is extended by a root of Y_j . It follows that $d = (\text{stems}(\pi), \text{sets}(\ell_1))$ is a \mathbb{P} -extension of $(\text{stems}(\pi), \text{sets}(\ell_0))$. \square

From the preceding fact, it follows that the S_j are as claimed. The rest of Properties 1–3 above are evident from the construction.

By Theorem 3.22, there is a level $N \in \mathbb{N}$ such that for every coloring $h : S_0(N) \times \dots \times S_{d-1}(N) \rightarrow k$, there is some $\ell < N$, some $\pi \in S_0(\ell) \times \dots \times S_{d-1}(\ell)$ and some $(\ell + 1)$ - π -dense matrix $M \subseteq S_0(N) \times \dots \times S_{d-1}(N)$ on which h is constant. Fix such an N . Let $(X_0, \dots, X_{d-1}) = \text{sets}(N - 1)$. In particular, for every $j < d$, $S_j(N) = \text{roots}(X_j)$.

Let W be the set of pairs $(x, v) \in \mathbb{N} \times \{0, 1\}$ such that for every k -partition $B_0 \sqcup \dots \sqcup B_{k-1} = \bigcup_n X_0(n) \times \dots \times X_{k-1}(n)$, there is some $\ell < N$, some $\pi \in S_0(\ell) \times \dots \times S_{d-1}(\ell)$, and for every $j < d$, a finite set $H_j \subseteq X_j$ such that if $(F_0, \dots, F_{d-1}) = \text{stems}(\pi)$ then the following hold:

- (a) $(F_0 \cup H_0, \dots, F_{d-1} \cup H_{d-1}) \in S_{<\omega}(T_0, \dots, T_{d-1})$;
- (b) $\bigcup_n H_0(n) \times \dots \times H_{d-1}(n) \subseteq B_i$ for some $i < k$;
- (c) $\Phi_e^{(F_0 \cup H_0) \oplus \dots \oplus (F_{d-1} \cup H_{d-1}) \oplus Z}(x) \downarrow = v$, where $e = \text{req}(\pi)$.

Note that although the trees S_0, \dots, S_{d-1} and the functions sets , stems and req are built non-effectively, only their restrictions to the height N are used. Therefore, since every finite object is computable, they do not add to the complexity of the set W . By compactness, the set W is $X_0 \oplus \dots \oplus X_{d-1} \oplus Z$ -c.e. We break into three cases.

Case 1: $(x, 1 - C(x)) \in W$ for some $x \in \mathbb{N}$. For $i < k$, let $B_i = A_i \cap \bigcup_n X_0(n) \times \dots \times X_{d-1}(n)$. Let $\ell < N$, $\pi = (F_0, \dots, F_{d-1})$ and H_0, \dots, H_{d-1} witness that $(x, 1 - C(x)) \in W$ for the partition B_0, \dots, B_{k-1} . Let ℓ_1 be the common level of the leaves of $F_j \cup H_j$ in X_j , and $\hat{X}_j = X_j \setminus \bigcup_{\ell_0 \leq \ell_1} X_j(\ell_0)$. Then $c' = (F_0 \cup H_0, \dots, F_{d-1} \cup H_{d-1}, \hat{X}_0, \dots, \hat{X}_{d-1})$ is a \mathbb{P} -extension of the condition $(F_0, \dots, F_{d-1}, X_0, \dots, X_{d-1})$ which, by Fact 3.26, is a \mathbb{P} -extension of $(\text{stems}(\pi), \text{sets}(\ell))$ since $\ell_1 \geq \ell$. Moreover

$$c' \Vdash \Phi_e^{G_0 \oplus \dots \oplus G_{d-1} \oplus Z} \neq C$$

where $e = \text{req}(\pi)$. This contradicts Property 3 above, according to which $(\text{stems}(\pi), \text{sets}(\ell))$ has no such \mathbb{P} -extension.

Case 2: $(x, C(x)) \notin W$ for some $x \in \mathbb{N}$. Let \mathcal{C} be the $\Pi_1^{0, X_0 \oplus \dots \oplus X_{d-1} \oplus Z}$ class of all sets $B_0 \oplus \dots \oplus B_{k-1}$ such that $B_0 \sqcup \dots \sqcup B_{k-1} = \bigcup_n X_0(n) \times \dots \times X_{d-1}(n)$ and such that for every $\ell < N$, every $\pi \in S_0(\ell) \times \dots \times S_{d-1}(\ell)$ and every $H_0 \subseteq X_0, \dots, H_{d-1} \subseteq X_{d-1}$, one of (a), (b) or (c) in the definition of W fails for the pair $(x, C(x))$. By assumption, $\mathcal{C} \neq \emptyset$.

By the cone avoidance basis theorem, there is some $B_0 \oplus \dots \oplus B_{k-1} \in \mathcal{C}$ such that $C \not\leq_T B_0 \oplus \dots \oplus B_{k-1} \oplus X_0 \oplus \dots \oplus X_{d-1} \oplus Z$. For $\pi \in \bigcup_n X_0(n) \times \dots \times X_{d-1}(n)$, write $B(\pi)$ for the unique $i < k$ such that $\pi \in B_i$. Recall that for every $j < d$, $S_j(N) = \text{roots}(X_j)$. We define a finite coloring g on $\bigcup_n X_0(n) \times \dots \times X_{d-1}(n)$ by

$$g(\sigma_0, \dots, \sigma_{d-1}) = B(\sigma_0, \dots, \sigma_{d-1}).$$

By Theorem 3.6 applied to g , there is a $B_0 \oplus \dots \oplus B_{k-1} \oplus X_0 \oplus \dots \oplus X_{d-1}$ -computable tuple of infinite strong subtrees $(Y_{j,\rho} : j < d, \rho \in S_j(N))$ of $(X_j \upharpoonright \rho : j < d, \rho \in S_j(N))$ with common level function, together with a coloring $h : S_0(N) \times \dots \times S_{d-1}(N) \rightarrow k-1$, such that

$$\bigcup_n Y_{0,\rho_0}(n) \times \dots \times Y_{d-1,\rho_{d-1}}(n) \subseteq B_{h(\pi)},$$

for every $\pi = (\rho_0, \dots, \rho_{d-1}) \in S_0(N) \times \dots \times S_{d-1}(N)$.

By choice of N , there is some $\ell < N$, some $\pi = (\nu_0, \dots, \nu_{d-1}) \in S_0(\ell) \times \dots \times S_{d-1}(\ell)$ and some $(\ell+1)$ - π -dense matrix $M \subseteq S_0(N) \times \dots \times S_{d-1}(N)$ on which h is constant. Say $M = M_0 \times \dots \times M_{d-1}$ and let $i < k$ be the color of h on this matrix. For every $j < d$, let P_j be the set of nodes in $S_j(N)$ which are not extensions of ν_j . For every $j < k$, let $\hat{Y}_j = \bigcup_{\rho \in M_j \cup P_j} Y_{j,\rho}$.

CLAIM 3.27. $(\text{stems}(\pi), \hat{Y}_0, \dots, \hat{Y}_{d-1}) \mathbb{P}\text{-extends } (\text{stems}(\pi), \text{sets}(\ell))$.

PROOF. Let $(\hat{X}_0, \dots, \hat{X}_{d-1}) = \text{sets}(\ell)$. Since $\ell < N$ and since $\text{sets}(N-1) = (X_0, \dots, X_{d-1})$, it follows by Fact 3.26 that the X_j are strong subtrees of the \hat{X}_j with common level function. Hence, so are the Y_j . Furthermore, by Property 1, for every $j < k$ we have that $\text{roots}(\hat{X}_j) = S_j(\ell+1)$. So every root of \hat{X}_j is extended by a root of \hat{Y}_j . \square

It follows by Property 3 that $(\text{stems}(\pi), \hat{Y}_0, \dots, \hat{Y}_{d-1}) \not\leq \Phi_e^{G_0 \oplus \dots \oplus G_{d-1} \oplus Z} \neq C$ where $e = \text{req}(\pi)$. Now, since the forcing relation depends only on part of the reservoirs extending the roots of the stems, the following fact holds. However, we have the following contradictory fact:

CLAIM 3.28. $(\text{stems}(\pi), \hat{Y}_0, \dots, \hat{Y}_{d-1}) \Vdash \Phi_e^{G_0 \oplus \dots \oplus G_{d-1} \oplus Z} \neq C$, where $e = \text{req}(\pi)$.

PROOF. For every $j < d$, let $H_j \subseteq \hat{Y}_j$ be such that $F_0 \cup H_0, \dots, F_{d-1} \cup H_{d-1}$ are finite strong subtrees of T_0, \dots, T_{d-1} , respectively, with common level function. Since the roots of the F_j pointwise extend π , so do the nodes of each of the H_j . In particular, for every $j < d$, $H_j \subseteq \bigcup_{\rho \in M_j} Y_{j,\rho}$. It follows that $\bigcup_n H_0(n) \times \dots \times H_{d-1}(n) \subseteq B_i$. But $B_0 \oplus \dots \oplus B_{k-1} \in \mathcal{C}$,

so $\Phi_e^{(F_0 \cup H_0) \oplus \dots \oplus (F_{d-1} \cup H_{d-1}) \oplus Z}(x)$ either diverges or is different from $C(x)$. Since the H_j were arbitrary, the claim is proved. \square

The contradiction completes Case 2.

Case 3: *otherwise.* Then $(x, y) \in W$ if and only if $y = C(x)$, which, since W is $X_0 \oplus \dots \oplus X_{d-1} \oplus Z$ -c.e., implies $C \leq_T X_0 \oplus \dots \oplus X_{d-1} \oplus Z$, a contradiction. \square

We are now ready to prove strong cone avoidance of the Halpern-Laüchli theorem.

PROOF OF THEOREM 3.21. Fix two sets C and Z such that $C \not\leq_T Z$. Also fix a tuple of infinite Z -computable Z -computably bounded trees with no leaves $T_0, \dots, T_{d-1} \subseteq \omega^{<\omega}$ and an arbitrary k -partition $A_0 \sqcup \dots \sqcup A_{k-1} = \bigcup_n T_0(n) \times \dots \times T_{d-1}(n)$. Let \mathbb{P} be the set of cone avoiding level-homogeneous product tree conditions (relative to these givens).

By Lemma 3.25, there is some $c \in \mathbb{P}$ below which, for every Turing functional Γ , the set

$$D_\Gamma = \{c' \in \mathbb{P} : c' \Vdash \Gamma^{G_0 \oplus \dots \oplus G_{d-1} \oplus Z} \neq C\}$$

is \mathbb{P} -dense. Let \mathcal{U} be a \mathbb{P} -filter which intersects every set D_Γ . Then by definition of a product tree condition, $G_0^\mathcal{U}, \dots, G_{d-1}^\mathcal{U}$ are strong subtrees of T_0, \dots, T_{d-1} . Moreover, since all conditions in \mathbb{P} are level-homogeneous, so are $G_0^\mathcal{U}, \dots, G_{d-1}^\mathcal{U}$. Since \mathcal{U} intersects every set D_Γ , then $C \not\leq_T G_0^\mathcal{U} \oplus \dots \oplus G_{d-1}^\mathcal{U} \oplus Z$. Last, by Lemma 3.11, $G_0^\mathcal{U}, \dots, G_{d-1}^\mathcal{U}$ are all infinite.

Let $f : \mathbb{N} \rightarrow k$ be the function which on level ℓ associates the color $i < k$ such that $G_0^\mathcal{U}(\ell) \times \dots \times G_{d-1}^\mathcal{U}(\ell) \subseteq A_i$. By strong cone avoidance of RT_k^1 , there is an infinite set of levels $H \subseteq \mathbb{N}$ on which f is constant and $C \not\leq_T H \oplus G_0^\mathcal{U} \oplus \dots \oplus G_{d-1}^\mathcal{U} \oplus Z$. Say f takes the color $i < k$ on H . In particular, for every $\ell \in H$, $G_0^\mathcal{U}(\ell) \times \dots \times G_{d-1}^\mathcal{U}(\ell) \subseteq A_i$, so we can $H \oplus G_0^\mathcal{U} \oplus \dots \oplus G_{d-1}^\mathcal{U} \oplus Z$ -computably thin out to infinite strong subtrees S_0, \dots, S_{d-1} of $G_0^\mathcal{U}, \dots, G_{d-1}^\mathcal{U}$ with common level function, and such that $\bigcup_n S_0(n) \times \dots \times S_{d-1}(n) \subseteq A_i$. In particular, $C \not\leq_T S_0 \oplus \dots \oplus S_{d-1} \oplus Z$. This completes the proof of Theorem 3.21. \square

CHAPTER 4

Milliken's tree theorem

We now turn to the computability-theoretic analysis of the product and non-product versions Milliken's tree theorem, the base cases of which we already studied through the Halpern-Lauchli theorem in the previous chapter. As the product version obviously implies the non-product, we formulate our upper bounds in terms of the former and our lower bounds in terms of the latter. More specifically, we obtain the following. In Section 4.1, we provide an inductive proof of the product version of Milliken's tree theorem in ACA_0 , using the notion of prehomogeneous tree. Using standard methods, it is easy to obtain a reversal for (even the non-product version of) Milliken's tree theorem for height at least 3. For height 1, we already saw in the previous chapter that the product version of Milliken's tree theorem for height 1 is computably true, and hence does not imply ACA_0 . This leaves the situation for trees of height 2, which we address in Section 4.2. Since Milliken's tree theorem for height two implies Ramsey's theorem for pairs, it is not computably true, but we show that the product version admits cone avoidance, and so is strictly weaker than ACA_0 . Finally, in Section 4.4, we study a weakening of Milliken's tree theorem that allows more than one color in the solutions. We prove that the product version of Milliken's tree theorem for height 3, but where up to two colors are allowed in the solution, admits cone avoidance, and hence does not imply ACA_0 . We will make use of this result in our discussion of Devlin's theorem in Chapter 5.

4.1. A proof of PMTT^n in ACA_0

Given a tree F of height $\alpha \leq \omega$ and an a number $n < \alpha$, we write $F \upharpoonright n$ for the subtree of F of height n .

DEFINITION 4.1. Fix $n \in \mathbb{N}$, a collection of trees T_0, \dots, T_{d-1} with no leaves and a coloring $f : \mathcal{S}_{n+1}(T_0, \dots, T_{d-1}) \rightarrow k$.

- (1) A tuple $(S_0, \dots, S_{d-1}) \in \mathcal{S}_\omega(T_0, \dots, T_{d-1})$ is *prehomogeneous* for f if the color of every $(E_0, \dots, E_{d-1}) \in \mathcal{S}_{n+1}(S_0, \dots, S_{d-1})$ depends only on $(E_0 \upharpoonright n, \dots, E_{d-1} \upharpoonright n)$.
- (2) A product tree condition $(F_0, \dots, F_{d-1}, X_0, \dots, X_{d-1})$ is *prehomogeneous* for f if the color of every

$$(E_0, \dots, E_{d-1}) \in \mathcal{S}_{n+1}(F_0 \cup X_0, \dots, F_{d-1} \cup X_{d-1})$$

depends only on $(E_0 \upharpoonright n, \dots, E_{d-1} \upharpoonright n)$ whenever $E_j \upharpoonright n \subseteq F_j$ for every $j < d$.

In particular, note that the product tree condition $(\emptyset, \dots, \emptyset, T_0, \dots, T_{d-1})$ is prehomogeneous for a given f as above.

We add several other useful definitions.

DEFINITION 4.2. Fix a collection of infinite trees T_0, \dots, T_{d-1} with no leaves. A product tree condition $c = (F_0, \dots, F_{d-1}, X_0, \dots, X_{d-1})$ is *computable* if X_0, \dots, X_{d-1} are all computable and computably bounded. An *index* of c is a finite tuple $(F_0, \dots, F_{d-1}, e_0, \dots, e_{d-1})$ such that $\Phi_{e_j} = X_j$ for every $j < d$.

DEFINITION 4.3. If $n \geq 1$ and T is a finite tree, then

$$\mathcal{S}_n^l(T) = \{S \in \mathcal{S}_n(T) : \text{leaves}(S) \subseteq \text{leaves}(T)\}.$$

More generally, if T_0, \dots, T_{d-1} are finite trees, then $\mathcal{S}_n^l(T_0, \dots, T_{d-1})$ equals

$$\{(S_0, \dots, S_{d-1}) \in \mathcal{S}_n(T_0, \dots, T_{d-1}) : (\forall i < d)[S_i \in \mathcal{S}_n^l(T_i)]\}.$$

The main combinatorial result of this section is the following density lemma.

LEMMA 4.4. *Fix $n \in \mathbb{N}$, a collection of computable, computably bounded trees with no leaves T_0, \dots, T_{d-1} , and a computable coloring*

$$f : \mathcal{S}_{n+1}(T_0, \dots, T_{d-1}) \rightarrow k.$$

For every computable product tree condition $c = (F_0, \dots, F_{d-1}, X_0, \dots, X_{d-1})$ which is prehomogeneous (for f), there is a computable prehomogeneous product tree condition $\hat{c} = (\hat{F}_0, \dots, \hat{F}_{d-1}, \hat{X}_0, \dots, \hat{X}_{d-1})$ extending c such that $F_j \subsetneq \hat{F}_j$ for every $j < d$. Moreover, an index of d can be found uniformly \emptyset'' -computably from an index of c .

PROOF. By definition of a product tree condition (Definition 3.7), for every $j < d$ and every leaf σ of F_j , $\text{roots}(X_j)$ is $(t+1)$ - σ -dense with respect to T_j , where t is the level of the leaves of F_j within T_j . For every $j < k$, let \hat{F}_j be F_j augmented by the roots of X_j extending the leaves of F_j . By Remark 3.9, we can assume that $(\hat{F}_0, \dots, \hat{F}_{d-1}) \in \mathcal{S}_{<\omega}(T_0, \dots, T_{d-1})$. Let

$$(E_0^0, \dots, E_{d-1}^0), \dots, (E_0^{p-1}, \dots, E_{d-1}^{p-1})$$

be the (finite) enumeration of all the tuples in $\mathcal{S}_n^l(\hat{F}_0, \dots, \hat{F}_{d-1})$, meaning tuples of strong subtrees (E_0, \dots, E_{d-1}) such that the leaves of E_j are among the leaves of \hat{F}_j , i.e., belong to $X_j(0)$.

We inductively define a finite sequence of d -tuples of computable forests

$$(Y_0^0, \dots, Y_{d-1}^0), \dots, (Y_0^p, \dots, Y_{d-1}^p)$$

such that for every $s < p$:

- (1) $Y_0^{s+1}, \dots, Y_{d-1}^{s+1}$ are infinite strong subforests of Y_0^s, \dots, Y_{d-1}^s , respectively, with common level function;
- (2) $(\hat{F}_0 \cup Y_0^{s+1}, \dots, \hat{F}_{d-1} \cup Y_{d-1}^{s+1}) \in \mathcal{S}_\omega(T_0, \dots, T_{d-1})$;

- (3) there is some color $i < k$ such that for every level $\ell \in \mathbb{N}$, every $j < d$, and every $H_j \subseteq Y_j^{s+1}(\ell)$ for which $(E_0^s \cup H_0, \dots, E_{d-1}^s \cup H_{d-1}) \in \mathcal{S}_{n+1}(T_0, \dots, T_{d-1})$, $f(E_0^s \cup H_0, \dots, E_{d-1}^s \cup H_{d-1}) = i$.

Let Y_0^0, \dots, Y_{d-1}^0 be X_0, \dots, X_{d-1} , respectively, trimmed by their first levels. Assume Y_0^s, \dots, Y_{d-1}^s is defined for $s < p$. Let m be the common level of the leaves of $\hat{F}_0, \dots, \hat{F}_{d-1}$ in T_0, \dots, T_{d-1} , respectively. For every $j < d$, let $R_j = \text{roots}(Y_j^s)$, and for every $\rho \in R_j$, let $Y_{j,\rho} = Y_j^s \upharpoonright \rho$. We can see Y_0^s, \dots, Y_{d-1}^s as a tuple $(Y_{j,\rho} : j < d, \rho \in R_j)$ of trees.

Define a coloring g of

$$\bigcup_m \left(\prod_{\rho \in R_0} Y_{0,\rho}(m) \right) \times \dots \times \left(\prod_{\rho \in R_{d-1}} Y_{d-1,\rho}(m) \right)$$

as follows. For every $j < d$, let $U_j = \{\rho \in R_j : (\exists \mu \in \text{leaves}(E_j^s))[\rho \succeq \mu]\}$, and note that $(E_0^s \cup U_0, \dots, E_{d-1}^s \cup U_{d-1}) \in \mathcal{S}_{n+1}(T_0, \dots, T_{d-1})$. Now, given $\pi = \{\sigma_{j,\rho} \in Y_{j,\rho} : j < d, \rho \in R_j\}$ in the domain of g , let

$$G_j = E_j^s \cup \{\sigma_{j,\rho} : \rho \in U_j\}.$$

for each j . So $(G_0, \dots, G_{d-1}) \in \mathcal{S}_{n+1}(T_0, \dots, T_{d-1})$. Set

$$g(\pi) = f(G_0, \dots, G_{d-1}).$$

Since the Halpern-Laüchli theorem is computably true, there is a computable tuple $(Z_{j,\rho} : j < d, \rho \in R_j)$ of strong subtrees of $(Y_{j,\rho} : j < d, \rho \in R_j)$, respectively, with common level function, together with a color $i < k$ such that for every $\ell \in \mathbb{N}$, every $j < k$, if $H_j \subseteq \prod_{\rho \in R_j} Z_{j,\rho}(\ell)$ is such that $E_j^s \cup H_j \in \mathcal{S}_{n+1}(T_0, \dots, T_{d-1})$ then $f(E_0^s \cup H_0, \dots, E_{d-1}^s \cup H_{d-1}) = i$. For every $j < k$, let $Y_j^{s+1} = \bigcup_{\rho \in R_j} Z_{j,\rho}(\ell)$. This completes the construction of the sequence.

Let $\hat{c} = (\hat{F}_0, \dots, \hat{F}_{d-1}, Y_0^p, \dots, Y_{d-1}^p)$. By items 1 and 2, \hat{c} is a computable product tree condition extending c . Moreover, by item 3 and the fact that c is prehomogeneous for f , so is \hat{c} .

One can \emptyset'' -computably search for a finite tuple

$$(E_0, \dots, E_{d-1}, e_0, \dots, e_{d-1})$$

such that for every $j < d$, Φ_{e_j} is total, and

$$(E_0, \dots, E_{d-1}, \Phi_{e_0}, \dots, \Phi_{e_{d-1}})$$

is a product tree condition extending c and prehomogeneous for f . Indeed, being a strong subforest of T_j is Π_2^0 since T_j is computable and computably bounded. Thus, being a product tree condition is \emptyset'' -decidable. Moreover, being prehomogeneous is Π_1^0 since f is computable, and being an extension of a product tree condition is also Π_2^0 . Since we prove the existence of such an extension, an exhaustive search will always terminate, and the procedure is \emptyset'' -computable, uniformly in an index of c . This completes the proof of Lemma 4.4. \square

LEMMA 4.5. *Fix $n \in \mathbb{N}$, a collection of computable, computably bounded trees with no leaves T_0, \dots, T_{d-1} , and a computable coloring*

$$f : \mathcal{S}_{n+1}(T_0, \dots, T_{d-1}) \rightarrow k.$$

There is a Δ_3^0 sequence S_0, \dots, S_{d-1} of strong subtrees of T_0, \dots, T_{d-1} , respectively, with common level function, such that the tuple (S_0, \dots, S_{d-1}) is prehomogeneous for f .

PROOF. By iterating Lemma 4.4, build a Δ_3^0 descending sequence of computable prehomogeneous product tree conditions $c_0 \geq c_1 \geq \dots$ where

$$c_s = (F_0^s, \dots, F_{d-1}^s, X_0^s, \dots, X_{d-1}^s)$$

and such that $F_j^s \subsetneq F_j^{s+1}$ for every $j < d$ and $s \in \mathbb{N}$. For every $j < d$, let $S_j = \bigcup_s F_j^s$. Since the F_j^s are strictly increasing in s , it follows by definition of a product tree condition that S_0, \dots, S_{d-1} are strong subtrees of T_0, \dots, T_{d-1} , respectively, with common level function. Moreover, S_0, \dots, S_{d-1} are Δ_3^0 , and by definition of a prehomogeneous condition, (S_0, \dots, S_{d-1}) is prehomogeneous for f . \square

THEOREM 4.6. *For every $n \geq 1$ and every set X , every X -computable instance of the product version of Milliken's tree theorem for height n admits a $\Delta_{2n-1}^{0,X}$ solution.*

PROOF. By induction on n . For $n = 1$, the product version of Milliken's tree theorem for height 1 is the Halpern-Laüchli theorem, which is computably true by Theorem 3.4.

Suppose the property holds for n , and fix a set X , and an X -computable sequence of X -computably bounded trees with no leaves $T_0, \dots, T_{d-1} \subseteq \omega^{<\omega}$. Let $f : \mathcal{S}_{n+1}(T_0, \dots, T_{d-1}) \rightarrow k$ be an X -computable coloring. By Lemma 4.5, relativized to X , there is a $\Delta_3^{0,X}$ tuple

$$(S_0, \dots, S_{d-1}) \in \mathcal{S}_\omega(T_0, \dots, T_{d-1})$$

prehomogeneous for f . Let $g : \mathcal{S}_n(S_0, \dots, S_{d-1}) \rightarrow k$ be defined by

$$g(E_0, \dots, E_{d-1}) = f(E_0 \cup H_0, \dots, E_{d-1} \cup H_{d-1})$$

for any $H_0 \subseteq S_0(n), \dots, H_{d-1} \subseteq S_{d-1}(n)$ such that $(E_0 \cup H_0, \dots, E_{d-1} \cup H_{d-1}) \in \mathcal{S}_{n+1}(S_0, \dots, S_{d-1})$. Such a coloring is well defined by prehomogeneity. The coloring g can be seen as a $\Delta_1^{0,X''}$ instance of the product version of Milliken's tree theorem for height n . By induction hypothesis, there is a $\Delta_{2n-1}^{0,X''}$ (hence $\Delta_{2(n+1)-1}^{0,X}$) solution to g , which is by prehomogeneity also a solution to f . This completes the proof of Theorem 4.6. \square

COROLLARY 4.7. *For every $n \geq 1$, the product version of Milliken's tree theorem for height n is provable in ACA_0 , and the product version of Milliken's tree theorem itself is provable in ACA'_0 .*

PROOF. The proof of Theorem 4.6 is formalizable in ACA_0 . The induction on n can then be carried out in ACA'_0 . \square

THEOREM 4.8. *Milliken's tree theorem for height n implies RT^n .*

PROOF. Let $f : [\mathbb{N}]^n \rightarrow k$ be an instance of RT^n . Let $T = 1^{<\omega} = \{\epsilon, 0, 00, \dots\}$ be the unary finitely branching tree with no leaves. Define $g : \mathcal{S}_n(T) \rightarrow k$ by $g(\sigma_0, \dots, \sigma_{n-1}) = f(|\sigma_0|, \dots, |\sigma_{n-1}|)$. Now if S is a strong subtree of T such that $\mathcal{S}_n(S)$ is monochromatic for g then $H = \{|\sigma| : \sigma \in S\}$ is homogeneous for f . \square

COROLLARY 4.9. *For every $n \geq 3$, PMTT^n and MTT^n are equivalent to ACA_0 over RCA_0 . Moreover the product version of Milliken's tree theorem and Milliken's tree theorem are equivalent to ACA'_0 .*

PROOF. For every $n \geq 3$, by Corollary 4.7, ACA_0 implies PMTT^n , which generalizes MTT^n . By Theorem 4.8, MTT^n implies RT^n , and by formalization of a result of Jockusch [23, Theorem 5.7] (as formalized e.g. in [41], Lemma III.7.5), RT^n implies ACA_0 . Moreover, by Corollary 4.7, ACA'_0 implies $(\forall n)\text{PMTT}^n$ which generalizes $(\forall n)\text{MTT}^n$. By Theorem 4.8, $(\forall n)\text{MTT}^n$ implies $(\forall n)\text{RT}^n$, which is itself known to imply ACA'_0 (for a proof, see Hirschfeldt [20], Theorem 6.27). \square

4.2. Cone avoidance of PMTT²

This section is devoted to the proof of cone avoidance of the product version of Milliken's tree theorem for height 2. As in the proof of cone avoidance for Ramsey's theorem for pairs (see Cholak, Jockusch and Slaman [3], Sections 3 and 4) the proof of Theorem 4.15 will be decomposed into two steps, using the notion of stability.

DEFINITION 4.10. Fix $n \geq 1$ and a collection of trees T_0, \dots, T_{d-1} with no leaves. A coloring $f : \mathcal{S}_{n+1}(T_0, \dots, T_{d-1}) \rightarrow k$ is *stable* if for every $(F_0, \dots, F_{d-1}) \in \mathcal{S}_n(T_0, \dots, T_{d-1})$, there is a threshold $t \in \mathbb{N}$ and a color $i < k$ such that for every level $\ell \geq t$ and all $E_0 \subseteq T_0(\ell), \dots, E_{d-1} \subseteq T_{d-1}(\ell)$ for which $(F_0 \cup E_0, \dots, F_{d-1} \cup E_{d-1}) \in \mathcal{S}_{n+1}(T_0, \dots, T_{d-1})$, $f(F_0 \cup E_0, \dots, F_{d-1} \cup E_{d-1}) = i$.

We refer to the $i < k$ above as the *limit color* of the tuple (F_0, \dots, F_{d-1}) . Any stable coloring $f : \mathcal{S}_{n+1}(T_0, \dots, T_{d-1}) \rightarrow k$ induces a coloring

$$g : \mathcal{S}_n(T_0, \dots, T_{d-1}) \rightarrow k$$

which to $(F_0, \dots, F_{d-1}) \in \mathcal{S}_n(T_0, \dots, T_{d-1})$ associates its limit color $i < k$. We shall call g the *limit coloring* of f . Note that g is Δ_2^0 in f and the sequence T_0, \dots, T_{d-1} . The notion of stability is therefore as bridge between computable instances of PMTT^{n+1} and arbitrary instances of PMTT^n . This gives rise to a two step proof of cone avoidance of PMTT^2 .

The first step consists of proving that for every instance of the product version of Milliken's tree theorem for height 2 there exist cone avoiding strong subtrees on which the coloring is stable. We will actually prove a more general theorem for products of trees, and subtrees of arbitrary height.

The second step consists of applying *strong* cone avoidance of the product version of Milliken's tree theorem for height 1, which is just a particular case of the Halpern-Laüchli theorem, and then computably thinning out the result to obtain a solution to the original instance of the product version of Milliken's tree theorem of height 2.

We begin with the first step.

THEOREM 4.11. *Fix sets $C, Z \subseteq \mathbb{N}$ with $C \not\leq_T Z$, an $n \geq 1$, a Z -computable collection of Z -computably bounded trees T_0, \dots, T_{d-1} with no leaves, and a coloring $f : \mathcal{S}_{n+1}(T_0, \dots, T_{d-1}) \rightarrow k$. There exists $(S_0, \dots, S_{d-1}) \in \mathcal{S}_\omega(T_0, \dots, T_{d-1})$ such that f is stable on $\mathcal{S}_{n+1}(S_0, \dots, S_{d-1})$ and such that $C \not\leq_T S_0 \oplus \dots \oplus S_{d-1} \oplus Z$.*

The proof of Theorem 4.11 will employ a refinement of the forcing with product tree conditions. We will require some definitions and preliminary lemmas.

DEFINITION 4.12. Fix sets $C, Z \subseteq \mathbb{N}$ with $C \not\leq_T Z$, an $n \geq 1$, a Z -computable collection of Z -computably bounded trees T_0, \dots, T_{d-1} with no leaves, and a coloring $f : \mathcal{S}_{n+1}(T_0, \dots, T_{d-1}) \rightarrow k$. Let

$$c = (F_0, \dots, F_{d-1}, X_0, \dots, X_{d-1})$$

be a product tree condition (with respect to the T_i).

- (1) c is *cone avoiding* if $C \not\leq_T X_0 \oplus \dots \oplus X_{d-1} \oplus Z$.
- (2) c is *stable* for f if for every tuple $(E_0, \dots, E_{d-1}) \in \mathcal{S}_n(F_0, \dots, F_{d-1})$, there is a color $i < k$ such that for every level $\ell \in \mathbb{N}$ and every $H_0 \subseteq X_0(\ell), \dots, H_{d-1} \subseteq X_{d-1}(\ell)$ for which $(E_0 \cup H_0, \dots, E_{d-1} \cup H_{d-1}) \in \mathcal{S}_{n+1}(T_0, \dots, T_{d-1})$, $f(E_0 \cup H_0, \dots, E_{d-1} \cup H_{d-1}) = i$.

Making progress in satisfying the cone avoidance requirements will demand the use of a computable function dominating the levels of a tuple of strong subtrees with certain nice combinatorial properties.

For now, we will take for granted the following technical result, which is a finite version of Milliken's tree theorem where all subtrees are assumed to keep the leaves and the level function is bounded. For a given tree T , recall the notation $\mathcal{S}_n^l(T)$ from Definition 4.3 which denotes the collection of strong subtrees of T of height n whose leaves are among those of T .

THEOREM 4.13. *Fix a level $\ell \in \mathbb{N}$, a height $n \geq 1$, a number of colors $k \in \mathbb{N}$, an arity $d \geq 1$, and a function $b : \omega \rightarrow \omega$. There exists a function $N \mapsto H(N, \ell, n + 1, k, d, b)$, uniformly b -computable in ℓ , n , k , and d , as follows. If U_0, \dots, U_{d-1} is a sequence of finite b -bounded trees of height $h = H(N, \ell, n + 1, k, d, b)$ for some fixed $N \in \mathbb{N}$, and*

$$\chi : \mathcal{S}_{n+1}^l(U_0, \dots, U_{d-1}) \rightarrow k$$

is any coloring where $\chi(F_0, \dots, F_{d-1})$ depends only on $(F_0 \upharpoonright n, \dots, F_{d-1} \upharpoonright n)$ whenever $F_i \upharpoonright n \subseteq U_i \upharpoonright \ell$ for every i , then there exists $(V_0, \dots, V_{d-1}) \in \mathcal{S}_{\ell+N+1}^l(U_0, \dots, U_{d-1})$ such that:

- (1) $V_i \upharpoonright \ell = U_i \upharpoonright \ell$ for each $i < d$;
- (2) for any $i < d$, the level function of V_i as a subset of U_i is bounded by the function defined by $x \mapsto H(x, \ell, n+1, k, d, b)$ if $x > \ell$, and $x \mapsto x$ if $x \leq \ell$;
- (3) the color of $(F_0, \dots, F_{d-1}) \in \mathcal{S}_{n+1}^l(V_0, \dots, V_{d-1})$ depends only on $(F_0 \upharpoonright n, \dots, F_{d-1} \upharpoonright n) \in \mathcal{S}_n(V_0, \dots, V_{d-1})$.

To help understand the statement of Theorem 4.13, suppose S_0, \dots, S_{d-1} are infinite, computable and computably bounded trees with no leaves. Also fix a coloring $g : \mathcal{S}_{n+1}(S_0, \dots, S_{d-1}) \rightarrow k$. Consider a product tree condition $(E_0, \dots, E_{d-1}, X_0, \dots, X_{d-1})$ for these S_i which is stable for g . Say the E_i are of height ℓ . One would like to extend the stems with N new levels in one step, so that the resulting stems are of height $\ell + N$, while keeping the resulting product tree condition stable for g . Theorem 4.13 provides a sufficient bound $h = H(N, \ell, n+1, k, d, b)$ depending on the number N of new levels we would like to add, on the height ℓ of the stems, the parameters $n+1$ and k of the coloring g , on the number d of trees in the product tree condition, and on the computable bound b over the trees $E_0 \cup X_0, \dots, E_{d-1} \cup X_{d-1}$, so that one can always find such an extension of the stems where the new elements are taken among the first h first levels of $E_0 \cup X_0, \dots, E_{d-1} \cup X_{d-1}$.

In the statement of Theorem 4.13, the finite trees U_0, \dots, U_{d-1} correspond to the trees $E_0 \cup X_0, \dots, E_{d-1} \cup X_{d-1}$ up to level h , respectively. Let Y_0, \dots, Y_{d-1} be the forests obtained from the trees $E_0 \cup X_0, \dots, E_{d-1} \cup X_{d-1}$ by removing their first $h-1$ many levels. For each $j < d$, the tree U_j therefore has three parts. First, we have the first ℓ levels, which correspond to to the stem E_j . Second, we have the levels up to the one before the leaves, which will serve to extend the stem E_j . Very few of these levels will be kept, but h is chosen large enough so that we can always extend with N new levels. Last, the leaves of U_j correspond to the roots of the forest Y_j .

Fixing strong subtrees $(F_0, \dots, F_{d-1}) \in \mathcal{S}_{n+1}^l(U_0, \dots, U_{d-1})$ of height $n+1$ should actually be understood as fixing strong subtrees $(F_0 \upharpoonright n, \dots, F_{d-1} \upharpoonright n)$ of height n from the trees U_0, \dots, U_{d-1} trimmed from their leaves, and then picking a set of roots from Y_0, \dots, Y_{d-1} (or equivalently picking a set of leaves from U_0, \dots, U_{d-1}). This induces a product coloring of the nodes in Y_0, \dots, Y_{d-1} pointwise extending the product of the roots chosen, by considering which color the function g assigns to the strong subtrees $(F_0 \upharpoonright n, \dots, F_{d-1} \upharpoonright n)$ augmented by these nodes. Multiple applications of the Halpern-Lauchli theorem yield subforests Z_0, \dots, Z_{d-1} of Y_0, \dots, Y_{d-1} with the same set of roots such that the induced coloring has a limit color on products of nodes from the Z_i . This limit color therefore depends only on the choice of element from $\mathcal{S}_{n+1}^l(U_0, \dots, U_{d-1})$. This is how we define the limit function $\chi : \mathcal{S}_{n+1}^l(U_0, \dots, U_{d-1})$.

The proof of Theorem 4.13 requires some rather heavy combinatorial development, and so we postpone it to the next section. Instead, we first show how to use the theorem to obtain Theorem 4.11.

LEMMA 4.14. *Fix sets $C, Z \subseteq \mathbb{N}$ with $C \not\leq_{\Gamma} Z$, an $n \geq 1$, a Z -computable collection of Z -computably bounded trees with no leaves T_0, \dots, T_{d-1} , and a coloring $f : \mathcal{S}_{n+1}(T_0, \dots, T_{d-1}) \rightarrow k$. Let \mathbb{P} be the partial order of all stable cone avoiding product tree conditions (with respect to the givens). For every \mathbb{P} -condition c and every Turing functional Γ , there is a \mathbb{P} -condition c' extending c such that $c' \Vdash \Gamma^{G_0 \oplus \dots \oplus G_{d-1} \oplus Z} \neq C$.*

PROOF. Fix $c = (F_0, \dots, F_{d-1}, X_0, \dots, X_{d-1})$. By Remark 3.9, we can assume that $(F_0 \cup X_0, \dots, F_{d-1} \cup X_{d-1}) \in \mathcal{S}_{\omega}(T_0, \dots, T_{d-1})$. Let $b : \mathbb{N} \rightarrow \mathbb{N}$ be a Z -computable function bounding the trees $F_0 \cup X_0, \dots, F_{d-1} \cup X_{d-1}$, and let ℓ be the height of F_0, \dots, F_{d-1} .

Let W be the set of all pairs $(x, v) \in \mathbb{N} \times \{0, 1\}$ such that for every d -tuple of strong subforests Y_0, \dots, Y_{d-1} of X_0, \dots, X_{d-1} , respectively, with common level function dominated by $N \mapsto H(N, \ell, n+1, k, d, b)$, and such that for every $j < d$, every root of X_j is extended by a root of Y_j , there is some d -tuple $H_0 \subseteq Y_0, \dots, H_{d-1} \subseteq Y_{d-1}$ with $(F_0 \cup H_0, \dots, F_{d-1} \cup H_{d-1}) \in \mathcal{S}_{<\omega}(T_0, \dots, T_{d-1})$ and

$$\Gamma^{(F_0 \cup H_0) \oplus \dots \oplus (F_{d-1} \cup H_{d-1}) \oplus Z}(x) \downarrow = v.$$

By compactness, the set W is $X_0 \oplus \dots \oplus X_{d-1} \oplus Z$ -c.e. We have three cases.

Case 1: $(x, 1 - C(x)) \in W$ for some $x \in \mathbb{N}$. By compactness, there is some height $N_0 \in \mathbb{N}$ such that the property holds for every d -tuple of strong subforests of X_0, \dots, X_{d-1} , respectively, of height N_0 with common level function dominated by $N \mapsto H(N, \ell, n+1, k, d, b)$. Let U_0, \dots, U_{d-1} be the finite trees obtained by restricting $F_0 \cup X_0, \dots, F_{d-1} \cup X_{d-1}$, respectively, to their first $H(N_0, \ell, n+1, k, d, b)$ many levels. In particular, U_0, \dots, U_{d-1} are b -bounded trees of height $H(N_0, \ell, n+1, k, d, b)$.

Fixing a tuple $(E_0, \dots, E_{d-1}) \in \mathcal{S}_{n+1}^l(U_0, \dots, U_{d-1})$, the coloring f induces a function

$$g : \bigcup_m \prod_{j < d} \prod_{\rho \in \text{leaves}(E_j)} (X_j \upharpoonright \rho)(m) \rightarrow k$$

define for all tuples $\pi = (\sigma_j^\rho \in (X_j \upharpoonright \rho)(m) : j < d, \rho \in \text{leaves}(E_j))$ by

$$g(\pi) = f(\{(E_j \upharpoonright n) \cup \{\sigma_j^\rho : \rho \in \text{leaves}(E_j)\} : j < d\}).$$

Thus, by iteratively applying strong cone avoidance of the Halpern-Laüchli theorem (Theorem 3.21), there is a d -tuple of strong subforests Y_0, \dots, Y_{d-1} of X_0, \dots, X_{d-1} , respectively, with common level function, such that:

- (a) for every $j < d$, every leaf of U_j is extended by exactly one root of Y_j ;
- (b) for every $(E_0, \dots, E_{d-1}) \in \mathcal{S}_{n+1}^l(U_0, \dots, U_{d-1})$, there is a color $i < k$ such that for every

$$(\sigma_j^\rho : j < d, \rho \in \text{leaves}(E_j)) \in \bigcup_m \prod_{\rho \in \text{leaves}(E_j)} (Y_j \upharpoonright \rho)(m),$$

we have $f(\{(E_j \upharpoonright n) \cup \{\sigma_j^\rho : \rho \in \text{leaves}(E_j)\} : j < d\}) = i$;
(c) $C \not\leq_T Y_0 \oplus \cdots \oplus Y_{d-1} \oplus Z$.

Item (b) induces a coloring $\chi : \mathcal{S}_{n+1}^l(U_0, \dots, U_{d-1}) \rightarrow k$ which associates to (E_0, \dots, E_{d-1}) the unique color $i < k$ as specified there. By Theorem 4.13, there are finite strong subtrees V_0, \dots, V_{d-1} of U_0, \dots, U_{d-1} , respectively, of height $N_0 + \ell$ with common level function, such that for every $j < d$, $V_j \upharpoonright \ell = F_j$, the level function of V_j is bounded by $N \mapsto H(N, \ell, n+1, k, d, b)$ if $N > \ell$, and the color of $(E_0, \dots, E_{d-1}) \in \mathcal{S}_{n+1}^l(V_0, \dots, V_{d-1})$ with respect to χ depends only on $(E_0 \upharpoonright n, \dots, E_{d-1} \upharpoonright n)$. By choice of N_0 , there are some $H_0 \subseteq V_0, \dots, H_{d-1} \subseteq V_{d-1}$ such that $F_0 \cup H_0, \dots, F_{d-1} \cup H_{d-1}$ are finite strong subtrees of T_0, \dots, T_{d-1} , respectively, with common level function, and such that

$$\Gamma^{(F_0 \cup H_0) \oplus \cdots \oplus (F_{d-1} \cup H_{d-1}) \oplus Z}(x) \downarrow = v.$$

The tuple $c' = (F_0 \cup H_0, \dots, F_{d-1} \cup H_{d-1}, Y_0, \dots, Y_{d-1})$ is therefore a cone avoiding stable product tree condition extending c that satisfies

$$c' \Vdash \Gamma^{G_0 \oplus \cdots \oplus G_{d-1} \oplus Z} \neq C.$$

Case 2: $(x, C(x)) \notin W$ for some $x \in \mathbb{N}$. Let \mathcal{C} be the class of all strong subtrees Y_0, \dots, Y_{d-1} of X_0, \dots, X_{d-1} , respectively, with common level function dominated by $N \mapsto H(N, \ell, n+1, k, d, b)$ such that for every $j < d$, every root of X_j is extended in a root of Y_j , and for every d -tuple $H_0 \subseteq Y_0, \dots, H_{d-1} \subseteq Y_{d-1}$ for which $F_0 \cup H_0, \dots, F_{d-1} \cup H_{d-1}$ are finite strong subtrees of T_0, \dots, T_{d-1} , respectively, again with common level function, we have

$$\Gamma^{(F_0 \cup H_0) \oplus \cdots \oplus (F_{d-1} \cup H_{d-1}) \oplus Z}(x) \uparrow \text{ or } \Gamma^{(F_0 \cup H_0) \oplus \cdots \oplus (F_{d-1} \cup H_{d-1}) \oplus Z}(x) \downarrow \neq v.$$

Since the trees T_0, \dots, T_{d-1} are Z -computably bounded and the level function of Y_0, \dots, Y_{d-1} is dominated by the Z -computable function H , it follows that \mathcal{C} is a Π_1^0 class relative to $X_0 \oplus \cdots \oplus X_{d-1} \oplus Z$. Moreover, by assumption, \mathcal{C} is non-empty.

By the cone avoidance basis theorem, there is some $(Y_0, \dots, Y_{d-1}) \in \mathcal{C}$ such that $C \not\leq_T Y_0 \oplus \cdots \oplus Y_{d-1} \oplus Z$. The tuple

$$c' = (F_0, \dots, F_{d-1}, Y_0, \dots, Y_{d-1})$$

is then a \mathbb{P} -condition extending c such that

$$c' \Vdash \Gamma^{G_0 \oplus \cdots \oplus G_{d-1} \oplus Z} \neq C.$$

Case 3: *otherwise.* Then we have that $(x, y) \in W$ if and only if $C(x) = y$, so $C \leq_T X_0 \oplus \cdots \oplus X_{d-1} \oplus Z$. \square

PROOF OF THEOREM 4.11. Fix two sets C and Z such that $C \not\leq_T Z$. Also fix a Z -computable collection of Z -computably bounded trees with no leaves $T_0, \dots, T_{d-1} \subseteq \omega^{<\omega}$. Let $n \geq 1$ and $f : \mathcal{S}_{n+1}(T_0, \dots, T_{d-1}) \rightarrow k$ be a coloring. Let \mathbb{P} be the partial order of all cone avoiding product tree conditions which are stable for f , and let \mathcal{U} be a sufficiently generic \mathbb{P} -filter.

Let $G_0^{\mathcal{U}}, \dots, G_{d-1}^{\mathcal{U}}$ be the strong subtrees of T_0, \dots, T_{d-1} induced by \mathcal{U} . By Lemma 4.14, for every Turing functional Γ , there is some \mathbb{P} -condition $c \in \mathcal{U}$ such that $c \Vdash \Gamma^{G_0^{\mathcal{U}} \oplus \dots \oplus G_{d-1}^{\mathcal{U}}} \neq C$. Hence, $C \not\leq_T G_0^{\mathcal{U}} \oplus \dots \oplus G_{d-1}^{\mathcal{U}} \oplus Z$. Moreover, by Lemma 3.11, $G_0^{\mathcal{U}}, \dots, G_{d-1}^{\mathcal{U}}$ are all infinite. And finally, since \mathcal{U} contains only stable conditions, f is stable on $\mathcal{S}_n(G_0, \dots, G_{d-1})$. This completes the proof of Theorem 4.11. \square

We are ready to prove cone avoidance of PMTT².

THEOREM 4.15. *The product version of Milliken's tree theorem for height 2 admits cone avoidance.*

PROOF. Fix two sets C and Z such that $C \not\leq_T Z$. Also fix a Z -computable collection of Z -computably bounded trees with no leaves $T_0, \dots, T_{d-1} \subseteq \omega^{<\omega}$ and a Z -computable coloring $f : \mathcal{S}_2(T_0, \dots, T_{d-1}) \rightarrow k$.

By Theorem 4.11, there are strong subtrees S_0, \dots, S_{d-1} of T_0, \dots, T_{d-1} , respectively, with common level function, such that f is stable on

$$\mathcal{S}_2(S_0, \dots, S_{d-1}),$$

and such that $C \not\leq_T S_0 \oplus \dots \oplus S_{d-1} \oplus Z$. By stability, the coloring f induces a k -partition $A_0 \sqcup \dots \sqcup A_{k-1} = \bigcup_n S_0(n) \times \dots \times S_{d-1}(n)$ by letting A_i be the set of tuples $(\sigma_0, \dots, \sigma_{d-1}) \in \bigcup_n S_0(n) \times \dots \times S_{d-1}(n)$ such that for all but finitely many levels $\ell \in \mathbb{N}$, whenever $(\{\sigma_0\} \cup H_0, \dots, \{\sigma_{d-1}\} \cup H_{d-1}) \in \mathcal{S}_2(S_0, \dots, S_{d-1})$ then $f(\{\sigma_0\} \cup H_0, \dots, \{\sigma_{d-1}\} \cup H_{d-1}) = i$.

By Theorem 3.21, there is some color $i < k$ and some strong subtrees U_0, \dots, U_{d-1} of S_0, \dots, S_{d-1} , respectively, with common level function, such that $\bigcup_n U_0(n) \times \dots \times U_{d-1}(n) \subseteq A_i$ and $C \not\leq_T U_0 \oplus \dots \oplus U_{d-1} \oplus Z$. By $U_0 \oplus \dots \oplus U_{d-1} \oplus Z$ -computably thinning out the set of levels, we can obtain a tuple of strong subtrees V_0, \dots, V_{d-1} of U_0, \dots, U_{d-1} , respectively, with common level function, such that $\mathcal{S}_2(V_0, \dots, V_{d-1})$ is monochromatic for color j with respect to f . In particular, by transitivity of the strong subtree relation, V_0, \dots, V_{d-1} are strong subtrees of T_0, \dots, T_{d-1} with common level function, and $C \not\leq_T V_0 \oplus \dots \oplus V_{d-1} \oplus Z$. This completes the proof. \square

COROLLARY 4.16. $\text{RCA}_0 \wedge \text{PMTT}^2 \not\vdash \text{ACA}_0$.

PROOF. Immediate by Theorem 4.15 and Lemma 2.15. \square

4.3. Proof of Theorem 4.13

We now prove the main technical result used in the preceding section. We shall restate it in full below for convenience. First, we have the following lemma.

LEMMA 4.17 (Finitary Halpern-Laüchli theorem for leaves). *Fix a number of colors $k \in \mathbb{N}$, an arity $d \geq 1$, and a function $b : \omega \rightarrow \omega$. There exists a function $N \mapsto h_{\text{HL}}(N, k, d, b)$, uniformly b -computable in k and d*

as follows. If U_0, \dots, U_{d-1} is a sequence of finite b -bounded trees of height $h = h_{\text{HL}}(N, k, d, b)$ for some fixed $N \geq 1$, and

$$g : U_0(h-1) \times \dots \times U_{d-1}(h-1) \rightarrow k$$

is any coloring of the d -tuples of leaves from this sequence, then there exists $(V_0, \dots, V_{d-1}) \in \mathcal{S}_N^l(U_0, \dots, U_{d-1})$, such that g is constant on the product of the leaves

$$V_0(N-1) \times \dots \times V_{d-1}(N-1).$$

PROOF. Let \mathcal{C} be the space of all functions

$$f : \bigcup_n T_0(n) \times \dots \times T_{d-1}(n) \rightarrow k$$

where T_0, \dots, T_{d-1} are b -bounded trees. By compactness of \mathcal{C} , the Halpern-Läuchli theorem (Theorem 2.28) yields the existence of a function

$$h_{\text{HL}}(\cdot, k, d, b) : \mathbb{N} \rightarrow \mathbb{N}$$

such that for any N , any collections of b -bounded trees T_0, \dots, T_{d-1} of height $h_{\text{HL}}(N, k, d, b)$, and any $f : \bigcup_{n < h_{\text{HL}}(N, k, d, b)} T_0(n) \times \dots \times T_{d-1}(n) \rightarrow k$, there exists $(S_0, \dots, S_{d-1}) \in \mathcal{S}_N(T_0, \dots, T_{d-1})$ such that f is constant on $\bigcup_{n < N} S_0(n) \times \dots \times S_{d-1}(n)$.

Now, consider the given trees U_0, \dots, U_{d-1} of height $h = h_{\text{HL}}(N, k, d, b)$, and the given coloring g . Define

$$f : \bigcup_{n < h} U_0(n) \times \dots \times U_{d-1}(n) \rightarrow k$$

by $f(\sigma_0, \dots, \sigma_{d-1}) = g(l_{\sigma_0}, \dots, l_{\sigma_{d-1}})$, where l_σ for each $\sigma \in U_i$ denotes a choice of leaf extending σ .

By the property of h_{HL} , let S_0, \dots, S_{d-1} be strong subtrees of T_0, \dots, T_{d-1} of height N and with a common level function such that f is constant on $\bigcup_{n < N} S_0(n) \times \dots \times S_{d-1}(n)$. For $i < d$, set

$$V_i = \bigcup_{n < N-1} S_i(n) \cup \{l_\sigma : \sigma \in S_i(N-1)\}.$$

Thus, $(V_0, \dots, V_{d-1}) \in \mathcal{S}_N^l(U_0, \dots, U_{d-1})$, and as f is constant on $S_0(N-1) \times \dots \times S_{d-1}(N-1)$ it follows that g is constant on $V_0(N-1) \times \dots \times V_{d-1}(N-1)$. (Note that by definition of the V_i and the l_σ , $V_0(N-1) \times \dots \times V_{d-1}(N-1)$ is a subset of $T_0(h-1) \times \dots \times T_{d-1}(h-1)$, the domain of g .) \square

We are now ready to prove Theorem 4.13 stated earlier. Recall that it is a finitary version of Milliken's tree theorem for $\mathcal{S}_{n+1}^l(\cdot)$, meaning that we color strong subtrees of a certain height that also preserve the leaves. We recall the full statement.

THEOREM 4.13. *Fix a level $\ell \in \mathbb{N}$, a height $n \geq 1$, a number of colors $k \in \mathbb{N}$, an arity $d \geq 1$, and a function $b : \omega \rightarrow \omega$. There exists a function $N \mapsto H(N, \ell, n+1, k, d, b)$, uniformly b -computable in ℓ , n , k , and d , as*

follows. If U_0, \dots, U_{d-1} is a sequence of finite b -bounded trees of height $h = H(N, \ell, n+1, k, d, b)$ for some fixed $N \in \mathbb{N}$, and

$$\chi : \mathcal{S}_{n+1}^l(U_0, \dots, U_{d-1}) \rightarrow k$$

is any coloring where $\chi(F_0, \dots, F_{d-1})$ depends only on $(F_0 \upharpoonright n, \dots, F_{d-1} \upharpoonright n)$ whenever $F_i \upharpoonright n \subseteq U_i \upharpoonright \ell$ for every i , then there exists $(V_0, \dots, V_{d-1}) \in \mathcal{S}_{\ell+N+1}^l(U_0, \dots, U_{d-1})$ such that:

- (1) $V_i \upharpoonright \ell = U_i \upharpoonright \ell$ for each $i < d$;
- (2) for any $i < d$, the level function of V_i as a subset of U_i is bounded by the function defined by $x \mapsto H(x, \ell, n+1, k, d, b)$ if $x > \ell$, and $x \mapsto x$ if $x \leq \ell$;
- (3) the color of $(F_0, \dots, F_{d-1}) \in \mathcal{S}_{n+1}^l(V_0, \dots, V_{d-1})$ depends only on $(F_0 \upharpoonright n, \dots, F_{d-1} \upharpoonright n) \in \mathcal{S}_n(V_0, \dots, V_{d-1})$.

We begin by giving the definition of the function H .

DEFINITION 4.18. Fix a level $\ell \in \mathbb{N}$, a height $n \geq 1$, a number of colors $k \in \mathbb{N}$, an arity $d \geq 1$, and a function $b : \omega \rightarrow \omega$. Define a function $N \mapsto \hat{H}(N, \ell, n, k, d, b)$ inductively as follows:

- (1) $\hat{H}(0, \ell, n, k, d, b) = 0$;
- (2) if $\hat{H}(N-1, \ell, n, k, d, b) = H_{N-1}$ is defined, then

$$\hat{H}(N, \ell, n, k, b) = \hat{H}(N-1, \ell, n, k, d, b) + h_{\text{HL}}(2, K, D, B),$$

where

- K is the cardinality of the set of all k -valued functions defined on

$$\mathcal{P}(U_0 \upharpoonright H_N) \times \dots \times \mathcal{P}(U_{d-1} \upharpoonright H_N) \times \mathcal{P}(U_0(H_N)) \times \dots \times \mathcal{P}(U_{d-1}(H_N))$$

for some b -bounded trees T_0, \dots, T_{d-1} ;

- $D = d \times \prod_{i < \ell} b(i) \prod_{i < H_{N-1}} b(\ell + i)$;
- B is the function $n \mapsto b(n + H_{N-1})$.

Define H by

$$H(N, \ell, n, k, d, b) = \ell + \hat{H}(N, \ell, n, k, d, b).$$

Note that D corresponds to a bound on the number of leaves of d many b -bounded trees of height $\ell + H_{N-1}$, and that B is a bounding function for subtrees of a b -bounded tree that contains all the levels starting from H_{N-1} . Figure 4.1 helps shed light on some of the parameters given to h_{HL} in the definition of H .

PROOF OF THEOREM 4.13. We proceed by induction on N , starting with $N = 0$. The base case holds by taking any

$$(V_0, \dots, V_{d-1}) \in \mathcal{S}_{\ell+1}^l(U_0, \dots, U_{d-1})$$

with $V_i \upharpoonright \ell = U_i \upharpoonright \ell$ for all $i < d$. These trees satisfy Items 1 and 2 by construction. Moreover, by assumption on χ , they also satisfy Item 3.

Now, suppose the result is true for some $N \geq 0$. To simplify notation, define $H_N = H(N, \ell, n + 1, k, d, b)$ and $H_{N+1} = H(N + 1, \ell, n + 1, k, d, b)$. The construction of the solution V_0, \dots, V_{d-1} is divided into three steps, summarized as follows.

- (1) We apply Lemma 4.17 to the collection of trees $U_i^\sigma = U_i \upharpoonright \sigma$ for $\sigma \in U_i(H_N)$ and a certain coloring with a large number of colors. This will yield strong subtrees V_i^σ of U_i^σ of height 2 with a common level function. In turn, these will induce a coloring of $\mathcal{S}_{n+1}^l(U_0 \upharpoonright H_N, \dots, U_{d-1} \upharpoonright H_N)$.
- (2) We apply the inductive hypothesis to $U_0 \upharpoonright H_N, \dots, U_{d-1} \upharpoonright H_N$ and the induced coloring, obtaining strong subtrees $\hat{V}_0, \dots, \hat{V}_{d-1}$.
- (3) For each $i < d$, we replace the leaves of \hat{V}_i by V_i^σ to get V_i .

We now give the details of each step of the construction.

Construction.

Step 1. We define a coloring

$$g : \prod_{i < d} \prod_{\sigma \in U_i(H_N)} \text{leaves}(U_i^\sigma) \rightarrow K,$$

where K is the finite set of all functions

$$\zeta : \mathcal{P}(U_0 \upharpoonright H_N) \times \dots \times \mathcal{P}(U_{d-1} \upharpoonright H_N) \times \mathcal{P}(U_0(H_N)) \times \dots \times \mathcal{P}(U_{d-1}(H_N)) \rightarrow k.$$

Let π be an element of the domain of g , meaning a tuple $((\tau_i^\sigma)_{\sigma \in U_i(H_N)})_{i < d}$ consisting of one leaf τ_i^σ from each tree U_i^σ . Then $g(\pi)$ is the function ζ defined as follows. Given $F_i \subseteq U_i \upharpoonright H_N$ and $G_i \subseteq U_i(H_N)$ for each $i < d$,

$$\zeta(F_0, \dots, F_{d-1}, G_0, \dots, G_{d-1}) = \chi((F_i \cup \{\tau_i^\sigma : \sigma \in G_i\})_{i < d})$$

if $(F_i \cup \{\tau_i^\sigma : \sigma \in G_i\})_{i < d} \in \mathcal{S}_{n+1}^l(U_0, \dots, U_{d-1})$, and

$$\zeta(F_0, \dots, F_{d-1}, G_0, \dots, G_{d-1}) = 0$$

otherwise. So in particular, $g(\pi)$ records the values of χ on all strong subtrees of height $n + 1$ that have leaves in π and all other nodes below level H_N in U_0, \dots, U_{d-1} .

By Lemma 4.17 applied to the collection of U_i^σ with the coloring g , using the fact that the height, $H_{N+1} - H_N$, of the trees is sufficiently large by definition of H , we obtain strong subtrees V_i^σ of U_i^σ of height 2 and with common level function such that g is constant on the product of the leaves of the V_i^σ . Call the value assumed by g on this product $\zeta_0 \in K$.

Step 2. The function ζ_0 naturally induces a coloring

$$\chi_N : \mathcal{S}_{n+1}^l(U_0 \upharpoonright H_N + 1, \dots, U_{d-1} \upharpoonright H_N + 1) \rightarrow k$$

as follows. Given (F_0, \dots, F_{d-1}) in the domain of χ_N , let

$$\chi_N(F_0, \dots, F_{d-1}) = \zeta_0(F_0 \upharpoonright n, \dots, F_{d-1} \upharpoonright n, \text{leaves}(F_0), \dots, \text{leaves}(F_{d-1})).$$

Note that by choice of the V_i^σ , if $((\tau_i^\sigma)_{\sigma \in U_i(H_N)})_{i < d}$ is any tuple consisting of one leaf τ_i^σ from each tree V_i^σ , then $(F_i \upharpoonright n \cup \{\tau_i^\sigma : \sigma \in \text{leaves}(F_i)\})_{i < d} \in \mathcal{S}_{n+1}^l(U_0, \dots, U_{d-1})$, so by definition we also have

$$\chi_N(F_0, \dots, F_{d-1}) = \chi((F_i \upharpoonright n \cup \{\tau_i^\sigma : \sigma \in \text{leaves}(F_i)\})_{i < d}).$$

By assumption on χ , it follows that if $F_i \upharpoonright \ell \subseteq (U_i \upharpoonright H_N + 1) \upharpoonright \ell = U_i \upharpoonright \ell$ for all $i < d$, then $\chi_N(F_0, \dots, F_{d-1})$ depends only on $(F_0 \upharpoonright n, \dots, F_{d-1} \upharpoonright n)$. We may thus apply the induction hypothesis to χ_N and the trees $U_0 \upharpoonright H_N + 1, \dots, U_{d-1} \upharpoonright H_N + 1$ to obtain a tuple of strong subtrees $(\hat{V}_0, \dots, \hat{V}_{d-1}) \in \mathcal{S}_{\ell+N+1}^l(U_0 \upharpoonright H_N + 1, \dots, U_{d-1} \upharpoonright H_N + 1)$.

Step 3. Finally, we glue the trees \hat{V}_i to the trees V_i^σ to finish the construction of the solution. More precisely, we let

$$V_i = \hat{V}_i \setminus \text{leaves}(\hat{V}_i) \cup \bigcup_{\sigma \in \text{leaves}(\hat{V}_i)} V_i^\sigma.$$

Note that the height of V_i is $\ell + N + 2$, as desired. This completes the construction.

Verification. We now prove that the collection of V_i is a solution. Item 1 is satisfied since it is satisfied by \hat{V}_i . This is because V_i extends $\hat{V}_i \setminus \text{leaves}(\hat{V}_i)$, and the height of \hat{V}_i is at least $\ell + 1$, so we have $V_i \upharpoonright \ell = (\hat{V}_i \setminus \text{leaves}(\hat{V}_i)) \upharpoonright \ell = \hat{V}_i \upharpoonright \ell = U_i \upharpoonright \ell$.

Item 2 is satisfied by construction.

It remains to verify Item 3. Suppose $(F_0, \dots, F_{d-1}) \in \mathcal{S}_{n+1}^l(V_0, \dots, V_{d-1})$. We consider two cases.

Case 1: $F_i(n-1) \subseteq V_i(\ell + N)$ for each $i < d$. Since $F_i \in \mathcal{S}_{n+1}^l(V_i)$ for each $i < d$ and there is only one level in V_i above $\ell + N$, the elements of $F_i(n) = \text{leaves}(F_i)$ are uniquely determined by those of $F_i(n-1)$. Namely, $F_i(n) = \{\sigma \in V_i(\ell + n + 1) : (\exists \tau \in F_i(n-1))[\tau \prec \sigma]\}$. Thus, F_i is completely determined by $F_i \upharpoonright n$, and so also $\chi(F_0, \dots, F_{d-1})$ depends only on $(F_0 \upharpoonright n, \dots, F_{d-1} \upharpoonright n)$.

Case 2: $F_i(n-1) \subseteq V_i \upharpoonright \ell + N$ for each $i < d$. In this case, we have $F_i \upharpoonright n \subseteq \hat{V}_i \setminus \text{leaves}(\hat{V}_i) \subseteq U_i \upharpoonright H_N$. So, if we define

$$\hat{F}_i = F_i \upharpoonright n \cup \{\sigma \in U_i(H_N) : (\exists \tau \in \text{leaves}(F_i))[\sigma \prec \tau]\}$$

then $(\hat{F}_0, \dots, \hat{F}_{d-1}) \in \mathcal{S}_{n+1}^l(\hat{V}_0, \dots, \hat{V}_{d-1})$. By choice of the \hat{V}_i , we know that $\chi_N(\hat{F}_0, \dots, \hat{F}_{d-1})$ depends only on $(\hat{F}_0 \upharpoonright n, \dots, \hat{F}_{d-1} \upharpoonright n) = (F_0 \upharpoonright n, \dots, F_{d-1} \upharpoonright n)$.

Separately, by definition of χ_N and choice of the V_i^σ , we have that if $((\tau_i^\sigma)_{\sigma \in U_i(H_N)})_{i < d}$ is any tuple consisting of one leaf τ_i^σ from each tree V_i^σ , then

$$\begin{aligned} \chi_N(\hat{F}_0, \dots, \hat{F}_{d-1}) &= \chi((\hat{F}_i \upharpoonright n \cup \{\tau_i^\sigma : \sigma \in \text{leaves}(\hat{F}_i)\})_{i < d}) \\ &= \chi((F_i \upharpoonright n \cup \{\tau_i^\sigma : \sigma \in \text{leaves}(\hat{F}_i)\})_{i < d}). \end{aligned}$$

Since the leaves of F_0, \dots, F_{d-1} form precisely such a tuple $((\tau_i^\sigma)_{\sigma \in U_i(H_N)})_{i < d}$ and $F_i \upharpoonright n \cup \text{leaves}(F_i) = F_i$ for each $i < d$, we conclude

$$\chi_N(\hat{F}_0, \dots, \hat{F}_{d-1}) = \chi(F_0, \dots, F_{d-1}).$$

Combining the previous two paragraphs, we find that $\chi(F_0, \dots, F_{d-1})$ depends only on $(F_0 \upharpoonright n, \dots, F_{d-1} \upharpoonright n)$, as was to be shown. \square

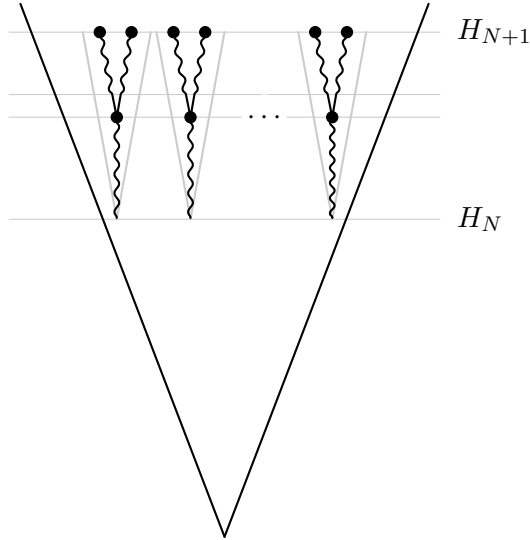

FIGURE 4.1. The construction of a tree in Theorem 4.13 when $d = 1$. Given a tree T of height H_N , cutting at level H_N yields a collection of finite perfect trees whose roots are nodes at level H_N . A finite coloring of $\mathcal{S}_{n+1}^l(T)$ yields a coloring of product of leaves from the collection, by merging the colors of all possible closure into a tree of height $n + 1$. The level H_{N+1} is chosen large enough above H_N so that one can apply Lemma 4.17 to obtain strong subtrees of height 2, represented in bold. As explained in the proof, this yields a coloring of $\mathcal{S}_n^l(T \upharpoonright H_N)$, and one can apply the induction hypothesis.

4.4. Milliken's tree theorem with more colors

As we have seen in the preceding sections, there is a computably detectable difference between Milliken's tree theorem for heights 2 and 3 that parallels that for Ramsey's theorem for pairs and triples. More specifically, Milliken's tree theorem for height 2 admits cone avoidance while the version for height 3 does not. In the case of Ramsey's theorem, more can be said. Wang [49, Theorem 3.2] proved the surprising result that if we weaken Ramsey's theorem for n -tuples to permit a larger number ℓ of colors in the

solution (instead of just one, which is to say, requiring the solutions to be homogeneous sets), and if ℓ is sufficiently large relative to n , then the resulting statement admits strong cone avoidance. More recently, Cholak and Patey [4, Corollary 4.17] gave explicit bounds on the relationship between ℓ and n , proving that cone avoidance holds so long as ℓ is at least as large as the n th Catalan number.

STATEMENT 4.19 (Ramsey's theorem for n -tuples and k colors). $\text{RT}_{k,\ell}^n$ is the statement: "For any coloring $f : [\mathbb{N}]^n \rightarrow k$, there exists an infinite set $H \subseteq \mathbb{N}$ such that f uses at most ℓ colors on $[H]^n$ ".

In this section, we prove a similar result for the product version of Milliken's tree theorem for height 2. More precisely, we show that whenever the number of colors in the solutions is allowed to be at least 2, then the resulting statement for height 2 admits strong cone avoidance (Theorem 4.27), while the statement for height 3 admits cone avoidance (Theorem 4.28).

The notion of level-homogeneous coloring sets a bridge between Ramsey's theorem and Milliken's tree theorem. Let $T_0, \dots, T_{d-1} \subseteq \omega^{<\omega}$ be finitely branching trees with no leaves. Recall that the level function witnessing a strong subtree is the function mapping the levels of the strong subtree to the levels in the original tree (see Definition 2.20).

DEFINITION 4.20. A coloring

$$f : \mathcal{S}_n(T_0, \dots, T_{d-1}) \rightarrow k$$

is *level-homogeneous* if the color of $(E_0, \dots, E_{d-1}) \in \mathcal{S}_n(T_0, \dots, T_{d-1})$ depends only on its level function. A product tree condition

$$(F_0, \dots, F_{d-1}, X_0, \dots, X_{d-1})$$

is *level-homogeneous* for f if for every

$$(E_0, \dots, E_{d-1}) \in \mathcal{S}_n(F_0 \cup X_0, \dots, F_{d-1} \cup X_{d-1})$$

such that $E_j \upharpoonright 1 \subseteq F_j$ for every $j < d$, the color of (E_0, \dots, E_{d-1}) depends only on its level function.

Note that the notion of level-homogeneous here extends that in Definition 3.24, which is the particular case when $n = 1$ and f is the function mapping a tuple in $\mathcal{S}_1(T_0, \dots, T_{d-1})$ to the unique $i < k$ such that A_i contains this tuple.

Any level-homogeneous coloring $f : \mathcal{S}_n(T_0, \dots, T_{d-1}) \rightarrow k$ induces a coloring $g : [\mathbb{N}]^n \rightarrow k$ which to some $F \in [\mathbb{N}]^n$ associates the color of any element of $\mathcal{S}_n(T_0, \dots, T_{d-1})$ whose level function has range F . This coloring g is well-defined by level-homogeneity of f , and for every homogeneous set $H \subseteq \mathbb{N}$ for g , the *principal function* $p_H : \mathbb{N} \rightarrow \mathbb{N}$, which to x associates the $(x + 1)$ st element of H in natural order, is the level function of a solution to f .

THEOREM 4.21. *Fix two sets C and Z such that $C \not\leq_T Z$. Also fix a Z -computable collection of Z -computably bounded trees with no leaves T_0, \dots, T_{d-1} . Let $f : \mathcal{S}_2(T_0, \dots, T_{d-1}) \rightarrow k$ be a coloring. Then, there exist strong subtrees $(S_0, \dots, S_{d-1}) \in \mathcal{S}_\omega(T_0, \dots, T_{d-1})$ over which f is level-homogeneous, and such that $C \not\leq_T S_0 \oplus \dots \oplus S_{d-1} \oplus Z$.*

PROOF. Fix $C, Z, T_0, \dots, T_{d-1}$ and f . By Theorem 4.11, there are strong subtrees $(U_0, \dots, U_{d-1}) \in \mathcal{S}_\omega(T_0, \dots, T_{d-1})$ on which f is stable, and such that $C \not\leq_T U_0 \oplus \dots \oplus U_{d-1} \oplus Z$.

We build strong subtrees $(G_0, \dots, G_{d-1}) \in \mathcal{S}_\omega(U_0, \dots, U_{d-1})$ on which f is level-homogeneous, and such that $C \not\leq_T G_0 \oplus \dots \oplus G_{d-1} \oplus Z$. These sets will be constructed by forcing with product tree conditions. Recall that a product tree condition $c = (F_0, \dots, F_{d-1}, X_0, \dots, X_{d-1})$ is *cone avoiding* (with respect to the given set C) if $C \not\leq_T X_0 \oplus \dots \oplus X_{d-1} \oplus Z$ (see Definition 3.24). Let \mathbb{P} be the collection of all cone avoiding product tree conditions which are level-homogeneous for f .

The proof of the following lemma is very similar to that of Lemma 3.25. In particular, we need again that condition extensions cannot remove roots of forests (see Definition 3.23).

LEMMA 4.22. *There is some condition $c \in \mathbb{P}$ such that for every Turing functional Γ , the set of conditions $c' \in \mathbb{P}$ such that $c' \Vdash \Gamma^{G_0 \oplus \dots \oplus G_{d-1} \oplus Z} \neq C$ is \mathbb{P} -dense below c .*

PROOF. Assume for the sake of contradiction that for every condition $c \in \mathbb{P}$, there is a Turing functional Γ and some extension, every further extension of which c' satisfies $c' \Vdash \Gamma^{G_0 \oplus \dots \oplus G_{d-1} \oplus Z} \neq C$.

As in Lemma 3.25, we build (non-effectively) a d -tuple S_0, \dots, S_{d-1} of infinite subsets of T_0, \dots, T_{d-1} , respectively, together with three functions:

1. $\text{sets} : \mathbb{N} \rightarrow \mathcal{P}(\omega^{<\omega}) \times \dots \times \mathcal{P}(\omega^{<\omega})$ which to a level $\ell \in \mathbb{N}$ associates a d -tuple X_0, \dots, X_{d-1} of infinite strong subforests of T_0, \dots, T_{d-1} , respectively, with common level function, such that $C \not\leq_T X_0 \oplus \dots \oplus X_{d-1} \oplus Z$ and such that for every $j < d$, $S_j(\ell + 1) = \text{roots}(X_j)$;
2. $\text{stems} : \bigcup_n S_0(n) \times \dots \times S_{d-1}(n) \rightarrow \mathcal{S}_{<\omega}(T_0, \dots, T_{d-1})$, which to a $\pi \in S_0(\ell) \times \dots \times S_{d-1}(\ell)$ associates a tuple (F_0, \dots, F_{d-1}) whose roots pointwise extend π , and such that $(F_0, \dots, F_{d-1}, \text{sets}(\ell))$ is a \mathbb{P} -condition;
3. $\text{req} : \bigcup_n S_0(n) \times \dots \times S_{d-1}(n) \rightarrow \mathbb{N}$, which to a $\pi \in S_0(\ell) \times \dots \times S_{d-1}(\ell)$ associates an index e of a Turing functional Φ_e such that for every \mathbb{P} -extension c' of $(\text{stems}(\pi), \text{sets}(\ell))$, $c' \Vdash \Phi_e^{G_0 \oplus \dots \oplus G_{d-1} \oplus Z} \neq C$.

Moreover, we require that for every level $\ell \in \mathbb{N}$, $\text{sets}(\ell + 1)$ are strong subforests of $\text{sets}(\ell)$ with common level function.

The construction is now exactly the same as in the proof Lemma 3.25. Moreover, the following fact still holds:

FACT 4.23. For every $\ell_0 < \ell_1$ and every $\pi \in S_0(\ell_0) \times \cdots \times S_{d-1}(\ell_0)$, the tuple $(\text{stems}(\pi), \text{sets}(\ell_1))$ is a \mathbb{P} -extension of $(\text{stems}(\pi), \text{sets}(\ell_0))$.

By Theorem 3.22, there is a level $N \in \mathbb{N}$ such that for every coloring $h : S_0(N) \times \cdots \times S_{d-1}(N) \rightarrow k$, there is some $\ell < N$, some $\pi \in S_0(\ell) \times \cdots \times S_{d-1}(\ell)$ and some $(\ell + 1)$ - π -dense matrix $M \subseteq S_0(N) \times \cdots \times S_{d-1}(N)$ monochromatic for h . Fix such an N . Let $(X_0, \dots, X_{d-1}) = \text{sets}(N - 1)$. In particular, for every $j < d$, $S_j(N) = \text{roots}(X_j)$.

Let W be the set of pairs $(x, v) \in \mathbb{N} \times \{0, 1\}$ such that for every k -coloring $g : \mathcal{S}_2(X_0, \dots, X_{d-1}) \rightarrow k$, there is some $\ell < N$, some $\pi \in S_0(\ell) \times \cdots \times S_{d-1}(\ell)$, and for every $j < d$, there is a finite set $H_j \subseteq X_j$ such that, letting $(F_0, \dots, F_{d-1}) = \text{stems}(\pi)$, the following holds

- (a) $(F_0 \cup H_0, \dots, F_{d-1} \cup H_{d-1}) \in \mathcal{S}_{<\omega}(U_0, \dots, U_{d-1})$;
- (b) g restricted to $\mathcal{S}_2(H_0, \dots, H_{d-1})$ is monochromatic for some $i < k$;
- (c) $\Phi_e^{(F_0 \cup H_0) \oplus \cdots \oplus (F_{d-1} \cup H_{d-1}) \oplus Z}(x) \downarrow = v$, where $e = \text{req}(\pi)$.

By compactness, the set W is $X_0 \oplus \cdots \oplus X_{d-1} \oplus Z$ -c.e. There are three cases:

Case 1: $(x, 1 - C(x)) \in W$ for some $x \in \mathbb{N}$. For $i < k$, let g be the restriction of f to $\mathcal{S}_2(X_0, \dots, X_{d-1})$. Let $\ell < N$, $\pi = (F_0, \dots, F_{d-1})$ and H_0, \dots, H_{d-1} witness that $(x, 1 - C(x)) \in W$ for g . Let ℓ_1 be a level large enough to witness stability of f for every level of H_j , and let $\hat{X}_j = X_j \setminus \bigcup_{\ell_0 \leq \ell_1} X_j(\ell_0)$. Then $c' = (F_0 \cup H_0, \dots, F_{d-1} \cup H_{d-1}, \hat{X}_0, \dots, \hat{X}_{d-1})$ is a \mathbb{P} -extension of $(F_0, \dots, F_{d-1}, X_0, \dots, X_{d-1})$ which, by Fact 4.23, is a \mathbb{P} -extension of $(\text{stems}(\pi), \text{sets}(\ell))$. Moreover

$$c' \Vdash \Phi_e^{G_0 \oplus \cdots \oplus G_{d-1} \oplus Z} \neq C$$

where $e = \text{req}(\pi)$. This contradicts item 3, according to which c has no such \mathbb{P} -extension.

Case 2: $(x, C(x)) \notin W$ for some $x \in \mathbb{N}$. Let \mathcal{C} be the $\Pi_1^{0, X_0 \oplus \cdots \oplus X_{d-1} \oplus Z}$ class of all colorings $g : \mathcal{S}_2(X_0, \dots, X_{d-1}) \rightarrow k$ such that for every $\ell < N$, every $\pi \in S_0(\ell) \times \cdots \times S_{d-1}(\ell)$ and every $H_0 \subseteq X_0, \dots, H_{d-1} \subseteq X_{d-1}$, one of (a), (b) or (c) fails for the pair $(x, C(x))$. By assumption, $\mathcal{C} \neq \emptyset$.

By the cone avoidance basis theorem, there is some $g \in \mathcal{C}$ such that $C \not\leq_{\text{T}} g \oplus X_0 \oplus \cdots \oplus X_{d-1} \oplus Z$. For every $j < d$, recall that $S_j(N) = \text{roots}(X_j)$. We can see X_0, \dots, X_{d-1} as a tuple $(X_j \upharpoonright \rho : j < d, \rho \in S_j(N))$ of trees. For every $\theta = (\rho_0, \dots, \rho_{d-1}) \in S_0(N) \times \cdots \times S_{d-1}(N)$, we let g_θ be the restriction of g over

$$\mathcal{S}_2(X_0 \upharpoonright \rho_0, \dots, X_{d-1} \upharpoonright \rho_{d-1}) \rightarrow k$$

By successive applications of cone avoidance of PMTT² (Theorem 4.15) applied to g_θ for each $\theta \in S_0(N) \times \cdots \times S_{d-1}(N)$, there is a tuple of infinite strong subtrees $(Y_{j,\rho} : j < d, \rho \in S_j(N))$ of $(X_j \upharpoonright \rho : j < d, \rho \in S_j(N))$ with common level function, together with a coloring $h : S_0(N) \times \cdots \times S_{d-1}(N) \rightarrow k$, such that for every $\theta = (\rho_0, \dots, \rho_{d-1}) \in S_0(N) \times \cdots \times S_{d-1}(N)$, g_θ restricted to $\mathcal{S}_2(X_0 \upharpoonright \rho_0, \dots, X_{d-1} \upharpoonright \rho_{d-1})$ is monochromatic for color $h(\theta)$.

By choice of N , there is some $\ell < N$, some $\pi = (\nu_0, \dots, \nu_{d-1}) \in S_0(\ell) \times \dots \times S_{d-1}(\ell)$ and some $(\ell + 1)$ - π -dense matrix $M \subseteq S_0(N) \times \dots \times S_{d-1}(N)$ monochromatic for h . Say $M = M_0 \times \dots \times M_{d-1}$ and $i < k$ is the color of monochromaticity. For every $j < d$, let P_j be the set of nodes in $S_j(N)$ which are not extensions of ν_j . For every $j < k$, let $\hat{Y}_j = \bigcup_{\rho \in M_j \cup P_j} Y_{j,\rho}$.

FACT 4.24. $c' = (\text{stems}(\pi), \hat{Y}_0, \dots, \hat{Y}_{d-1})$ is a \mathbb{P} -extension of $(\text{stems}(\pi), \text{sets}(\ell))$.

PROOF. Let $(\hat{X}_0, \dots, \hat{X}_{d-1}) = \text{sets}(\ell)$. By item 1, for every $j < k$, $\text{roots}(\hat{X}_j) = S_j(\ell + 1)$. In particular, every root of \hat{X}_j is extended by a root of \hat{Y}_j . \square

In particular, by Fact 4.23 and item 3, $c' \not\Vdash \Phi_e^{G_0 \oplus \dots \oplus G_{d-1} \oplus Z} \neq C$ where $e = \text{req}(\pi)$. Moreover, since the forcing relation depends only on part of the reservoirs extending the roots of the stems, the following fact holds.

FACT 4.25. $c' \Vdash \Phi_e^{G_0 \oplus \dots \oplus G_{d-1} \oplus Z} \neq C$, where $e = \text{req}(\pi)$.

PROOF. We claim that $c' \Vdash \Phi_e^{G_0 \oplus \dots \oplus G_{d-1} \oplus Z}(x) \neq C(x)$, where as usual the inequality includes the possibility that the left side diverges. For every $j < d$, let $H_j \subseteq \hat{Y}_j$ be such that $F_0 \cup H_0, \dots, F_{d-1} \cup H_{d-1}$ are finite strong subtrees of T_0, \dots, T_{d-1} , respectively, with common level function. In particular, for every $j < d$, $H_j \subseteq \bigcup_{\rho \in M_j} Y_{j,\rho}$, so g restricted to $\mathcal{S}_2(H_0, \dots, H_{d-1})$ is monochromatic for color i , hence since $g \in \mathcal{C}$, $\Phi_e^{(F_0 \cup H_0) \oplus \dots \oplus (F_{d-1} \cup H_{d-1}) \oplus Z}(x)$ either diverges, or is different from $C(x)$. This means

$$c' \Vdash \Phi_e^{G_0 \oplus \dots \oplus G_{d-1} \oplus Z}(x) \neq C(x),$$

as needed. \square

Fact 4.25 contradicts Fact 4.24 and item 3 of the construction, according to which c has no such \mathbb{P} -extension. This completes Case 2.

Case 3: *otherwise*. Then W is an $X_0 \oplus \dots \oplus X_{d-1} \oplus Z$ -c.e. graph of the characteristic function of C , hence $C \leq X_0 \oplus \dots \oplus X_{d-1} \oplus Z$. This is a contradiction. \square

We are now ready to complete the proof Theorem 4.21. By Lemma 4.22, there is some cone avoiding level-homogeneous product tree condition c below which, for every Turing functional Γ , the set

$$D_\Gamma = \{c' \in \mathbb{P} : c' \Vdash \Gamma^{G_0 \oplus \dots \oplus G_{d-1} \oplus Z} \neq C\}$$

is \mathbb{P} -dense. Let \mathcal{U} be a \mathbb{P} -filter which intersects every set D_Γ . Then by definition of a product tree condition, $G_0^\mathcal{U}, \dots, G_{d-1}^\mathcal{U}$ are strong subtrees of T_0, \dots, T_{d-1} . Moreover, since all conditions in \mathbb{P} are level-homogeneous, so are $G_0^\mathcal{U}, \dots, G_{d-1}^\mathcal{U}$. Since \mathcal{U} intersects every set D_Γ , we have $C \not\leq_T G_0^\mathcal{U} \oplus \dots \oplus G_{d-1}^\mathcal{U} \oplus Z$. Lastly, by Lemma 3.11, $G_0^\mathcal{U}, \dots, G_{d-1}^\mathcal{U}$ are all infinite. This completes the proof of Theorem 4.21. \square

STATEMENT 4.26. For all $n, k, \ell \geq 1$, $\text{PMTT}_{k,\ell}^n$ is the following statement. Let T_0, \dots, T_{d-1} be infinite trees with no leaves. For all colorings

$$f : \mathcal{S}_n(T_0, \dots, T_{d-1}) \rightarrow k$$

there exists $(S_0, \dots, S_{d-1}) \in \mathcal{S}_\omega(T_0, \dots, T_{d-1})$ such that f takes at most ℓ values on $\mathcal{S}_n(S_0, \dots, S_{d-1})$.

THEOREM 4.27. $(\forall k)\text{PMTT}_{k,2}^2$ admits strong cone avoidance.

PROOF. Fix two sets C and Z such that $C \not\leq_T Z$. Also fix a Z -computable collection of Z -computably bounded trees with no leaves $T_0, \dots, T_{d-1} \subseteq \omega^{<\omega}$. Let $f : \mathcal{S}_2(T_0, \dots, T_{d-1}) \rightarrow k$ be a coloring. By Theorem 4.21, there exist strong subtrees $(S_0, \dots, S_{d-1}) \in \mathcal{S}_\omega(T_0, \dots, T_{d-1})$ on which f is level-homogeneous, and such that $C \not\leq_T S_0 \oplus \dots \oplus S_{d-1} \oplus Z$.

Let $g : [\mathbb{N}]^2 \rightarrow k$ which to some $\{x_0 < x_1\} \in [\mathbb{N}]^2$ associates the color of any element of $\mathcal{S}_2(S_0, \dots, S_{d-1})$ whose level function has for range $\{x_0, x_1\}$. By strong cone avoidance of $\text{RT}_{k,2}^2$ (see Wang [49], Theorem 3.2, or Cholak and Patey [4], Corollary 4.17), there exists an infinite set $H \subseteq \mathbb{N}$ such that g restricted to $[H]^2$ uses at most 2 colors. Using H , one can compute strong subtrees $(U_0, \dots, U_{d-1}) \in \mathcal{S}_\omega(S_0, \dots, S_{d-1})$ whose level function is the principal function of H . By definition of g , f uses at most 2 colors over $\mathcal{S}_2(U_0, \dots, U_{d-1})$. And by transitivity of the strong subtree relation, $(U_0, \dots, U_{d-1}) \in \mathcal{S}_\omega(T_0, \dots, T_{d-1})$. This completes the proof of Theorem 4.27. \square

THEOREM 4.28. $(\forall k)\text{PMTT}_{k,2}^3$ admits cone avoidance.

PROOF. Fix two sets C and Z such that $C \not\leq_T Z$. Also fix a Z -computable collection of Z -computably bounded trees with no leaves $T_0, \dots, T_{d-1} \subseteq \omega^{<\omega}$. Let $f : \mathcal{S}_3(T_0, \dots, T_{d-1}) \rightarrow k$ be a Z -computable coloring.

By Theorem 4.11, there are strong subtrees

$$(S_0, \dots, S_{d-1}) \in \mathcal{S}_\omega(T_0, \dots, T_{d-1})$$

on which f is stable, and such that $C \not\leq_T S_0 \oplus \dots \oplus S_{d-1} \oplus Z$. Let $g : \mathcal{S}_2(S_0, \dots, S_{d-1})$ be the limit coloring induced by stability of f . By strong cone avoidance of $\text{PMTT}_{k,2}^2$ (Theorem 4.27), there are strong subtrees $(U_0, \dots, U_{d-1}) \in \mathcal{S}_\omega(S_0, \dots, S_{d-1})$ on which g uses at most 2 colors, and $C \not\leq_T U_0 \oplus \dots \oplus U_{d-1} \oplus Z$. By $U_0 \oplus \dots \oplus U_{d-1} \oplus Z$ -computably thinning out the set of levels, we can obtain a tuple of strong subtrees $(V_0, \dots, V_{d-1}) \in \mathcal{S}_\omega(U_0, \dots, U_{d-1})$, on which f uses at most 2 colors. In particular, by transitivity of the strong subtree relation, $(V_0, \dots, V_{d-1}) \in \mathcal{S}_\omega(T_0, \dots, T_{d-1})$. Last, $C \not\leq_T V_0 \oplus \dots \oplus V_{d-1} \oplus Z$. This completes the proof of Theorem 4.28. \square

COROLLARY 4.29. $(\forall k)\text{PMTT}_{k,2}^3$ does not imply ACA_0 over RCA_0 .

PROOF. Immediate by Theorem 4.28 and Lemma 2.15. \square

CHAPTER 5

Devlin’s theorem

We now turn to some applications of Milliken’s tree theorem and of our preceding work. We begin, in this chapter, with Devlin’s theorem. This states that the dense linear orders admit big Ramsey numbers, meaning that for every n there exists an ℓ such that for any finite coloring of the n -tuples of rationals, there exists a dense linear subordering of \mathbb{Q} on which the coloring takes only ℓ colors. This corresponds to the statement $(\forall k)DT_{k,\ell}^n$. Moreover, the function which associates to each n the minimal such ℓ is known, being the sequence of the so-called “odd tangent numbers” $t_{DT}(n)$, as defined in [48, p. 147]. (To list the first few, we have $t_{DT}(1) = 1$, $t_{DT}(2) = 2$, $t_{DT}(3) = 16$, and $t_{DT}(4) = 272$.)

Some variants of Devlin’s theorem, such as the Erdős-Rado theorem for colorings of rationals (see Section 5.5 below), have previously been studied in the reverse mathematics literature. So part of our motivation here is to see what new insights can be obtained using the tools from our earlier sections. Another, of course, is to understand more directly how Devlin’s theorem compares to Milliken’s tree theorem in its computable content. As remarked following Definition 2.38 above, one important idea here is to distinguish features that are intrinsic to a structure yet somehow hidden, as is the case when a structure has a big Ramsey degree bigger than 1. This is what we alluded to as being describable by an “enrichment” of the language and gives rise to the notion of big Ramsey structure (Definition 2.39). In the case of Devlin’s theorem, this can be made explicit using a representation of the rationals in terms of binary strings and so-called Joyce trees, which we define below. This is a somewhat technical construction, but it eliminates the need for more intricate combinatorial objects, such as embedding types, and will simplify our discussion not only of Devlin’s theorem but also of the Rado graph theorem which we consider in the next chapter.

5.1. A big Ramsey structure for dense linear orders

As noted below Statement 2.32 above, the big Ramsey degree of Devlin’s theorem for pairs is 2, while there is only one sub-order of size 2. We now describe an enrichment to the language of orders to obtain a big Ramsey structure for the dense linear orders with no endpoints which reflects this fact. We will see that we can represent any countable order as an anti-chain A in $2^{<\omega}$ with respect to the prefix relation, equipped with the lexicographic

order $<_{\text{lex}}$. Then, given two elements $\sigma, \tau \in A$, some extra structure induced by the string representation can be exploited, such as the comparison between the length of σ and the length of τ , but as well with respect to length of their meet $\sigma \wedge \tau$.

As we will see in Theorem 5.11 we can always ensure that the length of any string in $A^\wedge = \{\sigma \wedge \tau : \sigma, \tau \in A\}$ is unique. There are then 2 possible cases for a pair $\sigma <_{\text{lex}} \tau$ in A : either $|\sigma| >_{\mathbb{N}} |\tau|$, or $|\sigma| <_{\mathbb{N}} |\tau|$. The case of the equality has been ruled out since all lengths of the strings in A^\wedge will be unique. While there are examples where their lengths are not unique (see the figure below), the example where they are unique will prove to be very illustrative.

A finite subset of n elements in A can be represented as a particular kind of binary tree, known as a Joyce tree. A *Joyce tree* of size n is a labeled tree with $2n - 1$ vertices, such that every non-leaf has exactly two immediate children. The labels are among $\{1, \dots, 2n - 1\}$ and every child has a label greater than its parent (see Street [44]). See Figure 5.1 for some examples of Joyce trees.

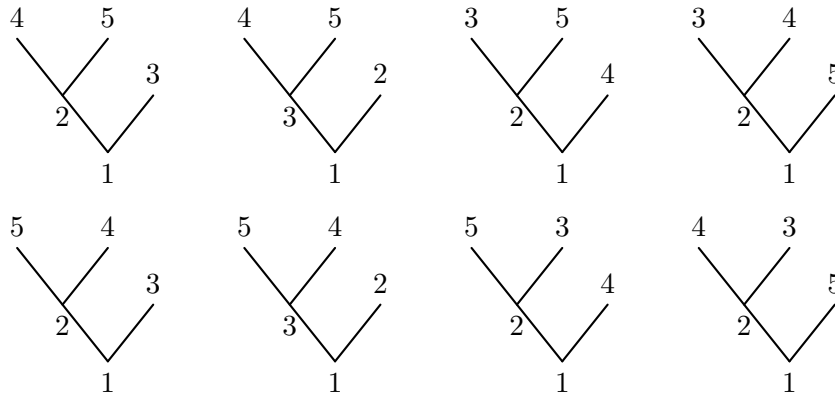

FIGURE 5.1. Eight Joyce trees among the sixteen Joyce trees with three leaves. The eight remaining Joyce trees are mirror reflections of these along a vertical axis through the root node.

Recall that a function is *symmetric* if its value is the same no matter the order of its arguments. In what follows, we use the string representation of a countable order $(X, <)$ to enrich the order with a symmetric binary function $\llbracket \cdot, \cdot \rrbracket : X^2 \rightarrow \mathbb{N}$. We shall later refer to any value of the range of $\llbracket \cdot, \cdot \rrbracket$ as a *label*. The label of an element $x \in X$ is $\llbracket x, x \rrbracket$ and $\llbracket x, y \rrbracket$ is the label given to $x \wedge y$. Again the illustrative example is when all lengths are unique, to consider the lengths of these nodes as the labels.

However there are other examples. Consider the first tree in Figure 5.1 and name its leaves x, y and z , from left to right. This tree induces a symmetric function $\llbracket \cdot, \cdot \rrbracket : \{x, y, z\}^2 \rightarrow \{1, \dots, 5\}$ as follows: $\llbracket x, x \rrbracket = 4$,

$\llbracket y, y \rrbracket = 5$, $\llbracket z, z \rrbracket = 3$, $\llbracket x, y \rrbracket = 2$, $\llbracket x, z \rrbracket = 1$, $\llbracket y, z \rrbracket = 1$. The tree representation also induces an ordering of the labels $\{1, \dots, 5\}$ by reading them from left to right. In this case, $4 < 2 < 5 < 1 < 3$. As we will later see in Lemma 5.4 ($\{x, y, z\}, <, \llbracket \cdot, \cdot \rrbracket$) can be used to recover the original Joyce tree.

DEFINITION 5.1. A *Joyce order* is an order $(X, <)$ equipped with a symmetric function $\llbracket \cdot, \cdot \rrbracket : X^2 \rightarrow \mathbb{N}$ such that for every $x, y, z, t \in X$, not all equal, with $x \leq y$ and $z \leq t$:

- (J1) $\llbracket x, y \rrbracket <_{\mathbb{N}} \llbracket x, z \rrbracket \implies (x < y \iff z < y)$;
- (J2) $\llbracket x, y \rrbracket <_{\mathbb{N}} \llbracket x, z \rrbracket \implies \llbracket x, y \rrbracket = \llbracket z, y \rrbracket$;
- (J3) $\llbracket x, y \rrbracket = \llbracket z, t \rrbracket \implies \llbracket x, y \rrbracket <_{\mathbb{N}} \min(\llbracket x, z \rrbracket, \llbracket y, t \rrbracket)$.

Note that the axioms of a Joyce order are universal, hence every subset of a Joyce order induces again a Joyce order.

Every Joyce tree gives rise to a Joyce order. Let X be the set of leaves, $\llbracket x, y \rrbracket$ be the label of the node $x \wedge y$, and $<_{\text{lex}}$ be the lexicographical order on X . Then, we claim that $(X, <_{\text{lex}}, \llbracket \cdot, \cdot \rrbracket)$ is a Joyce order: If $\llbracket x, y \rrbracket <_{\mathbb{N}} \llbracket x, z \rrbracket$, then as $x \wedge y$ and $x \wedge z$ are comparable and every child has a label greater than its parent, $x \wedge y < x \wedge z$. But then, $x <_{\text{lex}} y \iff (x \wedge z) <_{\text{lex}} y \iff z <_{\text{lex}} y$, and $x \wedge y = (x \wedge z) \wedge y = z \wedge y$, so both (J1) and (J2) hold. Finally let $x, y, z, t \in X$ not all equal be such that $\llbracket x, y \rrbracket = \llbracket z, t \rrbracket$. By injectivity of the labelling, $x \wedge y = z \wedge t$. If $x = y$ then $x \wedge y = x$ is a leaf, so $z \wedge t$ is a leaf, thus $x = y = z = t$, a contradiction. Therefore, $x \neq y$ and $z \neq t$. Now, suppose $y = z$. As a Joyce tree is binary branching, and $x <_{\text{lex}} y = z <_{\text{lex}} t$, one cannot have $x \wedge y = z \wedge t$, a contradiction. Finally suppose that x, y, z, t are all different. The fact that $x <_{\text{lex}} y$ and $z <_{\text{lex}} t$ implies $(x \wedge y)0 \preceq x$ and $(x \wedge y)0 \preceq z$, so $x \wedge y < x \wedge z$. By the fact that the label of a child is greater than those of its parents, $\llbracket x, y \rrbracket <_{\mathbb{N}} \llbracket x, z \rrbracket$. Similarly, $\llbracket x, y \rrbracket <_{\mathbb{N}} \llbracket y, t \rrbracket$.

We can use the illustrative example when $X \subseteq \omega^{<\omega}$, $<$ is $<_{\text{lex}}$, and all lengths in $X^\wedge = \{\sigma \wedge \tau : \sigma, \tau \in X\}$ are unique to get an intuition about these rules. Assume $x \wedge z$ is longer than $x \wedge y$. (J1) says that either y is to the left of both x and z (i.e. $y < x$ and $y < z$) or y is to the right of both x and z . (J2) says that $x \wedge y = z \wedge y$ (after all $x \wedge y \preceq x \wedge z$). The third axiom (J3) says that if both pairs x, y and z, t have a meet with the same label, $x < y$, and $z < t$, then $x \wedge z$ must properly above $x \wedge y$ and similarly for $y \wedge t$. This implies the meets are binary branching in X^\wedge . This also implies that different meets must have different labels.

LEMMA 5.2. *The following is true in any Joyce order $(X, <, \llbracket \cdot, \cdot \rrbracket)$:*

- (1) for all $x, y \in X$ with $x \neq y$, $\llbracket x, y \rrbracket <_{\mathbb{N}} \min(\llbracket x, x \rrbracket, \llbracket y, y \rrbracket)$;
- (2) for all $x, y \in X$ with $x \neq z$, $\llbracket x, x \rrbracket \neq \llbracket z, z \rrbracket$;
- (3) for all $x, z, t \in X$ with $z \neq t$, $\llbracket x, x \rrbracket \neq \llbracket z, t \rrbracket$.

PROOF. Item 1: by (J3) with $x = z$ and $y = t$. Item 2: by (J3) with $x = y$ and $z = t$, $\llbracket x, x \rrbracket = \llbracket z, z \rrbracket \implies \llbracket x, x \rrbracket <_{\mathbb{N}} \min(\llbracket x, z \rrbracket, \llbracket x, z \rrbracket)$. By Item 1, $\llbracket x, x \rrbracket <_{\mathbb{N}} \min(\llbracket x, z \rrbracket, \llbracket x, z \rrbracket)$ cannot hold, so $\llbracket x, x \rrbracket \neq \llbracket z, z \rrbracket$. Item 3: by (J3) with $x = y$, $\llbracket x, x \rrbracket = \llbracket z, t \rrbracket \implies \llbracket x, x \rrbracket <_{\mathbb{N}} \min(\llbracket x, z \rrbracket, \llbracket x, t \rrbracket)$. Since

$z \neq t$, then either $x \neq z$ or $x \neq t$. In either case, by Item 1, $\llbracket x, z \rrbracket <_{\mathbb{N}} \llbracket x, x \rrbracket$ or $\llbracket x, t \rrbracket <_{\mathbb{N}} \llbracket x, x \rrbracket$, so $\llbracket x, x \rrbracket <_{\mathbb{N}} \min(\llbracket x, z \rrbracket, \llbracket x, t \rrbracket)$ cannot hold, hence $\llbracket x, x \rrbracket \neq \llbracket z, t \rrbracket$. \square

The first item says that the label of $x \wedge y$ is less than the labels of x and y . The second says that each leaf has a unique label. The third says that no meet can have the same label as a leaf. Items 4 and 5 of the following lemma show that the labels of the leaves and meets are always different.

LEMMA 5.3. *Let $(X, <, \llbracket \cdot, \cdot \rrbracket)$ be a (finite or infinite) Joyce order with minimal label $\ell \in \omega$. Let $x \leq y \in X$ be such that $\llbracket x, y \rrbracket = \ell$ and let $X_x = \{z \in X : \llbracket x, z \rrbracket >_{\mathbb{N}} \ell\}$ and $X_y = \{z \in X : \llbracket y, z \rrbracket >_{\mathbb{N}} \ell\}$. The following holds:*

- (1) if $x = y$ then $|X| = 1$ and $X_x = X_y = \emptyset$;
- (2) if $x < y$ then $X = X_x \sqcup X_y$ with $x \in X_x$ and $y \in X_y$;
- (3) for all $z \in X_x$ and all $t \in X_y$, $z < t$ and $\llbracket z, t \rrbracket = \ell$;
- (4) the labels over X_x^2 and X_y^2 are disjoint;
- (5) if $|X| = n$ then there are $2n + 1$ distinct labels over X^2 .

PROOF. Item 1: Let $z \in X$. If $z \neq x$ we would have by Item 1 of Lemma 5.2 $\llbracket x, z \rrbracket <_{\mathbb{N}} \llbracket x, x \rrbracket$, a contradiction with the minimality of ℓ . Therefore, $z = x$ and $|X| = 1$. As $x \notin X_x \subseteq X$, $X_x = X_y = \emptyset$.

Item 2: Let $z \in X_x$. By (J2), we must have $\llbracket y, z \rrbracket = \ell$, and therefore $z \notin X_y$, so $X_x \cap X_y = \emptyset$. Now, let $t \in X$ such that $\llbracket x, t \rrbracket = \ell$. By (J3) applied with $x = z$, we have $\llbracket x, y \rrbracket < \llbracket y, t \rrbracket$, and so $t \in X_y$. By Item 1 of Lemma 5.2, $x \in X_x$ and $y \in X_y$.

Item 3: We have $\llbracket x, z \rrbracket > \ell = \llbracket x, y \rrbracket$, so by (J2), we must have $\llbracket y, z \rrbracket = \ell$. But we also have $\llbracket t, y \rrbracket > \ell = \llbracket y, z \rrbracket$, so by another application of (J2), we must have $\llbracket z, t \rrbracket = \ell$.

Item 4: Let $z_0, t_0 \in X_x$ and $z_1, t_1 \in X_y$. Suppose $\llbracket z_0, t_0 \rrbracket = \llbracket z_1, t_1 \rrbracket$. By application of (J3), we would have $\llbracket z_0, t_0 \rrbracket <_{\mathbb{N}} \llbracket z_0, t_1 \rrbracket$, however by Item 3 $\llbracket z_0, t_1 \rrbracket = \ell$, and $\llbracket z_0, t_0 \rrbracket <_{\mathbb{N}} \ell$ is a contradiction.

Item 5: By induction over $n \geq 1$. For $n = 1$, $X = \{x\}$, then the unique label is $\llbracket x, x \rrbracket$. For $n > 1$, assume by induction hypothesis that any non-empty Joyce order of size $m < n$ has $2m - 1$ distinct labels. Let $\ell \in \omega$ be the minimal label of X and let $x \leq y \in X$ be such that $\llbracket x, y \rrbracket = \ell$. Define X_x and X_y as above. By Item 1, since $|X| > 1$, then $x < y$. By Item 2, $X_x \neq \emptyset$ and $X_y \neq \emptyset$ and $X = X_x \sqcup X_y$. By induction hypothesis, there are $2|X_x| - 1$ distinct labels over X_x^2 and $2|X_y| - 1$ distinct labels over X_y^2 . By item 4, the labels are disjoint, so there are $2(|X_x| + |X_y|) - 2 = 2n - 2$ distinct labels over $X_x^2 \cup X_y^2$. Last, by Item 3, for every $z \in X_x$ and $t \in X_y$, $\llbracket z, t \rrbracket = \ell$, so the only label over $X_x \times X_y$ is ℓ . Therefore there are $2n - 1$ distinct labels over $X^2 = X_x^2 \cup X_y^2 \cup (X_x \times X_y)$. \square

LEMMA 5.4 (Representing a finite Joyce order as a Joyce tree). *There is a computable function J_X such that if $(X, <, \llbracket \cdot, \cdot \rrbracket)$ is a Joyce order of where*

$|X| = n$ then J_X is Joyce tree of size n . We shall refer to J_X as the Joyce tree coded by X .

PROOF. Let L be the set of labels over X^2 and l be the minimal label. For every string $\sigma \in 2^{<\omega}$, we will define a binary tree $J_{X,\sigma} \subseteq 2^{<\omega}$ whose root is σ , with $2n - 1$ nodes, such that every non-leaf has two immediate children, and every node has a unique label in L . The construction goes inductively as follows:

If $\ell = \llbracket x, x \rrbracket$ for some $x \in X$, then by Lemma 5.3, $X = \{x\}$ and $J_{X,\sigma} = \{\sigma\}$ where σ has label ℓ . If $\ell = \llbracket x, y \rrbracket$ with $x < y$, then let X_x and X_y be defined as in Lemma 5.3. By Item 2 of Lemma 5.3, $X = X_x \sqcup X_y$. By Items 3 and 4 of Lemma 5.3, $L = L_x \sqcup L_y \sqcup \{\ell\}$, where L_x and L_y are the sets of labels over X_x^2 and X_y^2 , respectively. By induction hypothesis one can define J_{X_x,σ_0} and J_{X_y,σ_1} , which are L_x -labelled and L_y -labelled, respectively. Then $J_{X,\sigma} = \{\sigma\} \sqcup J_{X_x,\sigma_0} \sqcup J_{X_y,\sigma_1}$ where σ is given label ℓ .

Let $v : L \rightarrow \{1, \dots, 2n - 1\}$ be the unique isomorphism between $(L, <_{\mathbb{N}})$ and $(\{1, \dots, 2n - 1\}, <_{\mathbb{N}})$ seen as linear orders. Then renaming the labels of $J_{X,\sigma}$ according to v , one obtains a Joyce tree J_X . \square

DEFINITION 5.5. The *Joyce structure* of a Joyce order is a structure $(X, <, R)$ such that for all x, y, z, t , $R(x, y, z, t) \iff \llbracket x, y \rrbracket < \llbracket z, t \rrbracket$. A *DLO Joyce structure* is the Joyce structure of a dense linear Joyce order with no endpoints.

By abuse of language, we may say that two Joyce orders are isomorphic whenever their corresponding Joyce structures are isomorphic. The construction of a Joyce tree from a Joyce order does not depend on the labels but on the ordering of the labels. Moreover two different orders of the labels yields two different Joyce trees. Hence the following lemma holds.

LEMMA 5.6 (RCA₀). *Two finite Joyce structures are isomorphic if and only if they yield the same Joyce tree.*

Just after the definition of a Joyce order, Definition 5.1, we showed every Joyce tree yielded a Joyce order which in turn yields a Joyce structure. Hence the number of Joyce tree of size n , Joyce orders of size n , and Joyce structure of size n are all the same. Street [44] shows that this is the odd tangent number of n (also see [48, p. 147]).

We now prove that every dense linear order with no endpoints can be enriched into a DLO Joyce structure. Actually, since these orders are computably categorical, that is, any two dense linear orders with no endpoints are isomorphic, and furthermore this isomorphism is computable in the orders, it suffices to prove the existence of a DLO Joyce order. For this, we need to consider the following ordering on $2^{<\omega}$:

DEFINITION 5.7 (the ordering $<_{\mathbb{Q}}$ on $2^{<\omega}$). Given two strings $\sigma, \tau \in 2^{<\omega}$, define $\sigma <_{\mathbb{Q}} \tau$ if and only if one of the following holds:

- (1) $\sigma \prec \tau$ and $\tau(|\sigma|) = 1$;

- (2) $\tau \prec \sigma$ and $\sigma(|\tau|) = 0$;
- (3) σ and τ are incomparable and $\sigma <_{\text{lex}} \tau$, where $<_{\text{lex}}$ is the lexicographical order.

Intuitively, if $\sigma <_{\mathbb{Q}} \tau$ then σ lies to the left of τ if one draws the standard picture of the tree $2^{<\omega}$, growing upwards from the root. (See, e.g., Figure 5.2.)

THEOREM 5.8 (RCA₀). *There exists a DLO Joyce order.*

PROOF. Let X be the rational language $(000 \cup 100)^*01$, that is, the set of strings $\sigma \in 2^{<\omega}$ of length $3n + 2$ for some $n \in \omega$, such that $\sigma(3n) = 0$, $\sigma(3n + 1) = 1$, and for every $j < n$, $\sigma(3j + 1) = \sigma(3j + 2) = 0$. For example, $10000010001 \in X$. In particular, X is an infinite antichain with respect to the prefix order. Let $<_{\text{lex}}$ be the lexicographic order restricted to X , that is, $\sigma <_{\text{lex}} \tau$ if $\sigma(|\sigma \wedge \tau|) <_{\mathbb{N}} \tau(|\sigma \wedge \tau|)$. Then $(X, <_{\text{lex}})$ is a dense linear order with no endpoints. Indeed, letting f be the natural one-to-one map from X to $2^{<\omega}$, f is an order isomorphism between $(X, <_{\text{lex}})$ and $(2^{<\omega}, <_{\mathbb{Q}})$ where $<_{\mathbb{Q}}$ is order defined in Definition 5.7. Last, fix an injective function $v : 2^{<\omega} \rightarrow \omega$ such that for every $\sigma, \tau \in 2^{<\omega}$, if $|\sigma| < |\tau|$ then $v(\sigma) < v(\tau)$, and for every $\sigma, \tau \in X$, define $\llbracket \sigma, \tau \rrbracket = v(\sigma \wedge \tau)$. Then $(X, <_{\text{lex}}, \llbracket \cdot, \cdot \rrbracket)$ is a dense linear Joyce order with no endpoints.

We prove that $(X, <_{\text{lex}}, \llbracket \cdot, \cdot \rrbracket)$ satisfies axioms (J1), (J2) and (J3). Let $x, y, z, t \in X$, not all equal, with $x \leq_{\text{lex}} y$ and $z \leq_{\text{lex}} t$.

Suppose $\llbracket x, y \rrbracket < \llbracket x, z \rrbracket$. By definition, $v(x \wedge y) < v(x \wedge z)$. By choice of the map v , $|x \wedge y| \leq |x \wedge z|$, so $x <_{\text{lex}} y$ iff $z <_{\text{lex}} y$. This shows (J1).

Now suppose $\llbracket x, y \rrbracket < \llbracket x, z \rrbracket$. By definition, $v(x \wedge y) < v(x \wedge z)$. By choice of the map v , $|x \wedge y| \leq |x \wedge z|$, so $x \wedge y = z \wedge y$, hence $v(x \wedge y) = v(z \wedge y)$. This shows (J2).

Finally, suppose $\llbracket x, y \rrbracket = \llbracket z, t \rrbracket$. By definition, $v(x \wedge y) = v(z \wedge t)$. By injectivity of the map v , $x \wedge y = z \wedge t$, so $x \wedge y \prec x \wedge z$ and $x \wedge y \prec y \wedge t$, hence $v(x \wedge y) <_{\mathbb{N}} \min(v(x \wedge z), v(y \wedge t))$. This shows (J3). \square

Depending on the choice of v in the above construction, the DLO Joyce orders won't be isomorphic. Consider the 3 leafs with the least labels. The leaf 01 always has the least label. The other 2 leafs with minimal labels are always $x = 00001$ and $y = 10001$. Note that $x < y$. Now the structures yielded by v_0 and v_1 where $v_0(00001) < v_0(10001)$ (hence the label of x is less than the label of y) and $v_1(00001) > v_1(10001)$ (hence the label of x is greater than the label of y) are not isomorphic.

COROLLARY 5.9 (RCA₀). *Every dense linear order with no endpoints $(X, <)$ can be equipped with a function $\llbracket \cdot, \cdot \rrbracket : X^2 \rightarrow \mathbb{N}$ to form a DLO Joyce order.*

PROOF. Let $(Y, <_Y, \llbracket \cdot, \cdot \rrbracket_Y)$ be the DLO Joyce order of Theorem 5.8. By computable categoricity of the dense linear orders with no endpoints, there exists an order isomorphism f between $(X, <)$ and $(Y, <_Y)$. Define

$[\cdot, \cdot] : X^2 \rightarrow \mathbb{N}$ by $[[x, y]] = [[f(x), f(y)]]_Y$. Then $(X, <, [[\cdot, \cdot]])$ is a DLO Joyce order. \square

One can canonically represent any countable Joyce order as a set of strings which are pairwise incomparable under the prefix relation, equipped with the lexicographic order the natural $[[\cdot, \cdot]]$ operation, that is, $[[\sigma, \tau]] = |\sigma \wedge \tau|$.

DEFINITION 5.10. A *coded Joyce order* is a Joyce order of the form $(X, <_{\text{lex}}, |\cdot \wedge \cdot|)$, with $X \subseteq 2^{<\omega}$, where $|\sigma \wedge \tau|$ is the length of the longest common prefix of σ and τ , such that for all $\sigma, \tau, \rho \in X$ with $|\rho| > |\sigma \wedge \tau|$ and $\sigma \wedge \tau \not\leq \rho$, then $\rho(|\sigma \wedge \tau|) = 0$.

In particular, letting $\sigma = \tau$, if $|\rho| > |\sigma|$, then $\rho(|\sigma|) = 0$. Since a coded Joyce order is fully specified by its set X , we shall simply refer to X when talking about the coded Joyce order $(X, <_{\text{lex}}, |\cdot \wedge \cdot|)$. Note that any subset of a coded Joyce order is again a coded Joyce order, since the axioms are universal.

THEOREM 5.11 (RCA₀). *Every countable Joyce order is isomorphic to a coded Joyce order.*

PROOF. Let $(X, <, [[\cdot, \cdot]])$ be a countable Joyce order. Let L be the set of labels over X^2 . For every $x \in X$, let L_x be the set of labels $\ell \in L$ such that $\ell <_{\mathbb{N}} [[x, x]]$ and such that there is some $y \in X$ such that $y < x$ and $[[y, x]] = \ell$. Let $\sigma_x \in 2^{<\omega}$ be the unique string of length $[[x, x]]$, such that for every $j < [[x, x]]$, $\sigma_x(j) = 1$ if and only if $j \in L_x$. Let $Y = \{\sigma_x : x \in X\}$.

CLAIM 5.12. $(Y, <_{\text{lex}}, |\cdot \wedge \cdot|)$ is isomorphic to $(X, <, [[\cdot, \cdot]])$.

PROOF. We first prove that for all $x, y, z, t \in X$, $[[x, y]] < [[z, t]] \implies |\sigma_x \wedge \sigma_y| <_{\mathbb{N}} |\sigma_z \wedge \sigma_t|$. We actually prove the stronger fact that for every $x, y \in X$, $[[x, y]] = |\sigma_x \wedge \sigma_y|$. If $x = y$, it is clear as by construction, σ_x is of length $[[x, x]]$. If $x \neq y$, we first prove that $[[x, y]] \leq |\sigma_x \wedge \sigma_y|$: indeed, for all $\ell < [[x, y]]$, by (J2) we have $\ell \in L_x$ if and only if $\ell \in L_y$. It remains to show $[[x, y]] \geq |\sigma_x \wedge \sigma_y|$: if $x < y$ we have that $[[x, y]] \in L_y \setminus L_x$, and if $y < x$, $[[x, y]] \in L_x \setminus L_y$. So in any case, $\sigma_x([[x, y]]) \neq \sigma_y([[x, y]])$, so $|\sigma_x \wedge \sigma_y| \leq [[x, y]]$.

Let $x < y \in X$. Then, $[[x, y]] \notin L_x$, as if z is such that $[[x, z]] = [[x, y]]$, then by (J3) $[[x, y]] <_{\mathbb{N}} [[y, z]]$ and by (J1) and the fact that $x < y$, we have $x < z$. So $\sigma_x(|x \wedge y|) = \sigma_x([[x, y]]) = 0$. However, $[[x, y]] \in L_y$ as witnessed by x , so $\sigma_y(|x \wedge y|) = \sigma_y([[x, y]]) = 1$. Therefore, $\sigma_x <_{\text{lex}} \sigma_y$. \square

CLAIM 5.13. $(Y, <_{\text{lex}}, |\cdot \wedge \cdot|)$ is a coded Joyce order.

PROOF. By the previous claim, $(Y, <_{\text{lex}}, |\cdot \wedge \cdot|)$ is a Joyce order isomorphic to $(X, <, [[\cdot, \cdot]])$. Fix $\sigma_x, \sigma_y, \sigma_z \in Y$ with $|\sigma_z| > |\sigma_x \wedge \sigma_y|$ and $\sigma_x \wedge \sigma_y \not\leq \sigma_z$. Assume $x \leq y$ without loss of generality. Let $\ell = [[x, y]] = |\sigma_x \wedge \sigma_y|$. Suppose for the contradiction that $\ell \in L_z$. Then there is some $u \in X$ with $u < z$ such that $[[u, z]] = |\sigma_u \wedge \sigma_z| = \ell = [[x, y]] = |\sigma_x \wedge \sigma_y|$. Since $u < z$, then $\sigma_u <_{\text{lex}} \sigma_z$ and since $x \leq y$ and $u < z$, by (J3), $|\sigma_y \wedge \sigma_z| >_{\mathbb{N}} \ell$ and $|\sigma_u \wedge \sigma_x| >_{\mathbb{N}} \ell$.

Let $\ell_0 = |\sigma_y \wedge \sigma_z|$. In particular, $\sigma_x \wedge \sigma_y = \sigma_x \wedge \sigma_y \upharpoonright \ell_0 = \sigma_x \wedge \sigma_z \upharpoonright \ell_0$, so $\sigma_x \wedge \sigma_y \preceq \sigma_z$, contradiction. So $\ell \notin L_z$, hence $\sigma_z(\ell) = 0$. \square

This completes the proof of Theorem 5.11. \square

Note that the proof in Theorem 5.11 yields a coded Joyce order whose set of lengths correspond exactly to the labels of the original Joyce order.

REMARK 5.14. Since Joyce structures only consider the ordering between the labels and not their actual value, we can always pick a Joyce order isomorphic to the original one, whose set of labels is an initial segment of \mathbb{N} , and using Theorem 5.11, we can represent it as a coded Joyce order whose lengths coincide with the labels, and hence form an initial segment of \mathbb{N} .

Todorcevic [48, Lemma 6.20] made an explicit construction of a computable coded DLO Joyce order, under a different terminology.

COROLLARY 5.15. *There exists a computable coded DLO Joyce order.*

PROOF. Immediate by Theorem 5.11 and Theorem 5.8. \square

5.2. A proof of Devlin's theorem

Note that the substructure of any Joyce structure is a Joyce structure, with the same witness function $|\cdot \wedge \cdot|$. Not all DLO Joyce structures are isomorphic, as already remarked in the paragraph below Theorem 5.8. However they all contain all Joyce structures. In particular, two DLO Joyce structures might not be isomorphic, but there exists an embedding from the first to the second, as well as from the second to the first.

THEOREM 5.16 (RCA₀). *Let \mathbb{X} be a DLO Joyce structure, and \mathbb{F} be a (finite or infinite) Joyce structure. Then, there exists an embedding from \mathbb{F} to \mathbb{X} .*

PROOF. Let $(X, <_{\text{lex}}, |\cdot \wedge \cdot|)$ be a computably coded DLO Joyce order with Joyce structure \mathbb{X} , which can always be found using Corollary 5.15. Let $(F, <_{\text{lex}}, |\cdot \wedge \cdot|)$ be a Joyce order of \mathbb{F} . By Remark 5.14, we can suppose that the length of the elements of F^\wedge form an initial segment of \mathbb{N} . The cardinality of F^\wedge , $S \in \omega \cup \{\omega\}$, is that for all $s < S$, then there exists a unique element of F^\wedge of length s , σ_s . We need to include the meets in our construction, so instead of building a map from F to X , we build a map from F^\wedge to X . In the end, restricting the mapping to F will yield the embedding.

By induction on $s < S$, we build x_s, a_s and b_s such that:

- (1) $x_s, a_s, b_s \in X$;
- (2) $a_s <_{\text{lex}} x_s <_{\text{lex}} b_s$;
- (3) $|a_s \wedge b_s| <_{\mathbb{N}} |x_s| <_{\mathbb{N}} |a_{s+1} \wedge b_{s+1}|$;
- (4) If $t < s$ and $\sigma_t \prec \sigma_s$, then: If $\sigma_s(t) = 0$, then x_s, a_s, b_s are in the interval (a_t, x_t) . Similarly, if $\sigma_s(t) = 1$, then x_s, a_s, b_s are in the interval (x_t, b_t) .

Suppose that a_t, b_t and x_t are defined for $t < s$. Let $t_0 < s$ be biggest such that there exists $\tau \in F$ such that $|\sigma_s \wedge \tau| = t_0$. Let A be the interval (a_{t_0}, x_{t_0}) if $\sigma_s(t_0) = 0$, and A be the interval (x_{t_0}, b_{t_0}) if $\sigma_s(t_0) = 1$. In either case A is a dense linear Joyce order with no endpoints. Let $a_s, b_s \in A$ such that $|a_s \wedge b_s| \succ_{\mathbb{N}} |x_{s-1}|$: They exist as A is infinite and $|A| \geq n$ implies $|\{|\sigma \wedge \tau| : \sigma \neq \tau \in A\}| \geq \log_2(n)$. Define x_s to be any element of (a_s, b_s) , which has to verify $|a_s \wedge b_s| < |x_s|$. Items 1, 2 and 3 are satisfied, as well as item 4 for t_0 . By definition of t_0 , if $\sigma_t \prec \sigma_s$, then either $t = t_0$ or $\sigma_t \prec \sigma_{t_0}$. In the former case, item 4 for t is satisfied. In the latter case, as a_{t_0}, σ_{t_0} and b_{t_0} satisfy item 4, $x_{t_0}, a_{t_0}, b_{t_0}$ are in the interval specified by item 4. But then, so are x_s, a_s, b_s , so they satisfy item 4 for all t .

We now define the embedding ϕ : if $y \in F$, then $\phi(y)$ is defined to be $x_{|y \wedge y|}$. It remains to show that ϕ is an embedding. An important fact is the following: If $x \prec_{\text{lex}} y \in F$, and $t = |x \wedge y|$, then $|a_t \wedge b_t| \leq_{\mathbb{N}} |\phi(x) \wedge \phi(y)| <_{\mathbb{N}} |x_t|$. Indeed, by Item 4 $\phi(x) \in (a_t, x_t)$ and $\phi(y) \in (x_t, b_t)$. Combining the fact with Item 3, we get that $|x \wedge y| <_{\mathbb{N}} |z \wedge t|$ implies $|\phi(x) \wedge \phi(y)| <_{\mathbb{N}} |\phi(z) \wedge \phi(t)|$.

Now suppose that for $x, y, z, t \in F$ with $x \prec_{\text{lex}} y$ and $z \prec_{\text{lex}} t$, $|x \wedge y| = |z \wedge t| = s$. This implies that $s_0 = |x \wedge z| \succ_{\mathbb{N}} s$ and $s_1 = |y \wedge t| \succ_{\mathbb{N}} s$. But then by Item 3 and the fact of the previous paragraph, $|\phi(x) \wedge \phi(z)| \succ_{\mathbb{N}} |a_{s_0} \wedge b_{s_0}| \succ_{\mathbb{N}} |x_s| \succ_{\mathbb{N}} |\phi(x) \wedge \phi(y)|$ and $|\phi(y) \wedge \phi(t)| \succ_{\mathbb{N}} |a_{s_0} \wedge b_{s_0}| \succ_{\mathbb{N}} |x_s| \succ_{\mathbb{N}} |\phi(x) \wedge \phi(y)|$. Therefore, by (J2), $|\phi(x) \wedge \phi(y)| = |\phi(z) \wedge \phi(t)|$.

Finally, suppose $x \prec_{\text{lex}} y \in F$. Let $s = |x \wedge y|$, by Item 4 we have $\phi(x) \in (a_s, x_s)$ and $\phi(y) \in (x_s, b_s)$ so $\phi(x) \prec_{\text{lex}} \phi(y)$. \square

The *age* of a structure Mc is the set of all its finitely generated substructures.

COROLLARY 5.17. *The age of any DLO Joyce structure is the set of finite Joyce structures.*

THEOREM 5.18 (RCA₀). *There exists a DLO Joyce order*

$$(2^{<\omega}, \prec_T, \llbracket \cdot, \cdot \rrbracket_T)$$

such that for every coded Joyce order X , the Joyce structures of

$$(X, \prec_T, \llbracket \cdot, \cdot \rrbracket_T)$$

and

$$(X, \prec_{\text{lex}}, | \cdot \wedge \cdot |)$$

are isomorphic.

PROOF. Let $(U, \prec_{\text{lex}}, \llbracket \cdot, \cdot \rrbracket_U)$ be the DLO Joyce order defined in Theorem 5.8, that is, $U = (000 \cup 100)^*01$ and $\llbracket \sigma, \tau \rrbracket_U = v(\sigma \wedge \tau)$ for some injective function $v : 2^{<\omega} \rightarrow \omega$ such that for every $\sigma, \tau \in 2^{<\omega}$, if $|\sigma| < |\tau|$ then $v(\sigma) < v(\tau)$.

Define the DLO Joyce order $(2^{<\omega}, \prec_T, \llbracket \cdot, \cdot \rrbracket_T)$ as follows: Given $\sigma \in 2^{<\omega}$, let $\hat{\sigma}$ be the binary string of length $3|\sigma| + 2$ defined for every $j < |\sigma|$ by

$\hat{\sigma}(3j) = \sigma(j)$, $\hat{\sigma}(3j+1) = \hat{\sigma}(3j+2) = 0$, and $\hat{\sigma}(3|\sigma|) = 0$ and $\hat{\sigma}(3|\sigma|+1) = 1$. For instance, if $\sigma = 0110$ then $\hat{\sigma} = 00010010000001$. Let $\sigma <_T \tau$ if and only if $\hat{\sigma} <_{\text{lex}} \hat{\tau}$ and $\llbracket \sigma, \tau \rrbracket_T = \llbracket \hat{\sigma}, \hat{\tau} \rrbracket_U$.

Let X be a coded Joyce order. We shall now show that $(X, <_T, \llbracket \cdot, \cdot \rrbracket_T)$ and $(X, <_{\text{lex}}, | \cdot \wedge \cdot |)$ are isomorphic via the identify function.

Fix $\sigma, \tau \in X$. If $\sigma <_{\text{lex}} \tau$, then $\hat{\sigma} <_{\text{lex}} \hat{\tau}$, hence $\sigma <_T \tau$. Conversely, if $\sigma <_T \tau$, then $\hat{\sigma} <_{\text{lex}} \hat{\tau}$, but since σ and τ are incomparable with respect to the prefix relation, this implies that $\sigma <_{\text{lex}} \tau$. Thus $\sigma <_T \tau$ if and only if $\sigma <_{\text{lex}} \tau$.

Fix $\sigma, \tau, \rho, \mu \in X$. If $|\sigma \wedge \tau| <_{\mathbb{N}} |\rho \wedge \mu|$, then $|\hat{\sigma} \wedge \hat{\tau}| <_{\mathbb{N}} |\hat{\rho} \wedge \hat{\mu}|$, then $v(\hat{\sigma} \wedge \hat{\tau}) <_{\mathbb{N}} v(\hat{\rho} \wedge \hat{\mu})$, hence $\llbracket \sigma, \tau \rrbracket_T <_{\mathbb{N}} \llbracket \rho, \mu \rrbracket_T$. Conversely, assume $\llbracket \sigma, \tau \rrbracket_T <_{\mathbb{N}} \llbracket \rho, \mu \rrbracket_T$. Unfolding the definition, $v(\hat{\sigma} \wedge \hat{\tau}) <_{\mathbb{N}} v(\hat{\rho} \wedge \hat{\mu})$. If $|\hat{\sigma} \wedge \hat{\tau}| \neq |\hat{\rho} \wedge \hat{\mu}|$, then by definition of v , $|\hat{\sigma} \wedge \hat{\tau}| <_{\mathbb{N}} |\hat{\rho} \wedge \hat{\mu}|$, hence $|\sigma \wedge \tau| <_{\mathbb{N}} |\rho \wedge \mu|$. If $|\hat{\sigma} \wedge \hat{\tau}| = |\hat{\rho} \wedge \hat{\mu}|$, then, since X is a coded Joyce order, $\sigma \wedge \tau = \rho \wedge \mu$, so $\hat{\sigma} \wedge \hat{\tau} = \hat{\rho} \wedge \hat{\mu}$ and $v(\hat{\sigma} \wedge \hat{\tau}) = v(\hat{\rho} \wedge \hat{\mu})$, contradiction. \square

DEFINITION 5.19. A *Joyce order diagonalization* for some Joyce order

$$(U, <_U, \llbracket \cdot, \cdot \rrbracket_U)$$

is a function $h : 2^{<\omega} \rightarrow U$, such that for every coded Joyce order X ,

$$(h[X], <_U, \llbracket \cdot, \cdot \rrbracket_U)$$

is isomorphic to $(X, <_{\text{lex}}, | \cdot \wedge \cdot |)$.

COROLLARY 5.20 (RCA₀). *Every DLO Joyce order $(U, <_U, \llbracket \cdot, \cdot \rrbracket_U)$ has a Joyce order diagonalization.*

PROOF. Let $(2^{<\omega}, <_T, \llbracket \cdot, \cdot \rrbracket_T)$ be the Joyce order of Theorem 5.18. By Theorem 5.16, there is an embedding $h : 2^{<\omega} \rightarrow U$. By definition of an embedding, for every coded Joyce order $X \subseteq 2^{<\omega}$, $(h[X], <_U, \llbracket \cdot, \cdot \rrbracket_U)$ is isomorphic to $(X, <_T, \llbracket \cdot, \cdot \rrbracket_T)$. By Theorem 5.18, $(X, <_T, \llbracket \cdot, \cdot \rrbracket_T)$ is isomorphic to $(X, <_{\text{lex}}, | \cdot \wedge \cdot |)$. Thus h is a Joyce order diagonalization. \square

The following lemma bridges finite coded Joyce orders of size n and strong subtrees of $2^{<\omega}$ of height $2n - 1$, by showing that any coded Joyce order of size n is a subset of a strong subtree of size $2n - 1$, and, conversely, any strong subtree of height $2n - 1$ is a superset of at most one coded Joyce order of size n .

LEMMA 5.21. *Let F be a finite coded Joyce order of size n and $T \in \mathcal{S}_\omega(2^{<\omega})$. Then every $E \in \mathcal{S}_{2n-1}(T)$ contains at most one coded Joyce order isomorphic to F . Moreover, every coded Joyce order $H \subseteq T$ isomorphic to F is included in some $E \in \mathcal{S}_{2n-1}(T)$.*

PROOF. Let $E \in \mathcal{S}_{2n-1}(T)$, h its level function and $F_0, F_1 \subseteq E$ be two coded Joyce orders isomorphic to F . By Item 5 of Lemma 5.3, the set $\{|\sigma \wedge \tau| : \sigma, \tau \in F_0\}$ has cardinality $2n - 1$, and similarly for F_1 .

Remark that F_0 and F_1 are uniquely identified as the set of leaves of respectively F_0^\wedge and F_1^\wedge , and that the isomorphism between F_i and F can

be extended to an isomorphism between F_i^\wedge and F^\wedge , where the element of length $h(j)$ (or equivalently of level j) of F_i^\wedge is mapped to the element of level j of F . Let ℓ be the first level, if it exists, where $F_0^\wedge \upharpoonright h(\ell) \neq F_1^\wedge \upharpoonright h(\ell)$. Let $\sigma_i \in F_i^\wedge$ be the unique element of $F_i^\wedge(\ell)$, and σ the unique element of $F(\ell)$. For every $j < \ell$, the values of $\sigma_0(h(j)) = \sigma_1(h(j))$ are determined: 0 iff there is a τ where $\sigma <_{\text{lex}} \tau \in F^\wedge(j)$ and 1 iff there is a τ where $\sigma >_{\text{lex}} \tau \in F^\wedge(j)$. As E is a strong subtree, determining the values of σ at levels $h(j)$ for $h(j) < |\sigma_i|$ entirely defines σ_i . Therefore, $F_0^\wedge = F_1^\wedge$ and $F_0 = F_1$.

For the second part, let $H \subseteq T$ be a coded Joyce order isomorphic to F . We claim that H is included in some $E \in \mathcal{S}_{2n-1}(T)$. Let $H^\wedge = \{\sigma \wedge \tau : \sigma, \tau \in H\}$ be the \wedge -closure of H . In particular, H^\wedge is a finite tree of height $2n-1$ with exactly one string at each level. Since $T \in \mathcal{S}_\omega(2^{<\omega})$ and $H \subseteq T$ then $H^\wedge \subseteq T$. Let $L = \{\ell_0 < \dots < \ell_{2n-2}\}$ be the set of levels of the nodes of H^\wedge in T . Let E be the largest (in the sense of inclusion) subtree of T of height $2n-1$ containing H^\wedge such that for every $i < 2n-1$, $E(i) \subseteq T(\ell_i)$. We claim that for every $i < 2n-2$, every node $\sigma \in E(i)$ is 2-branching in E . Since $E \subseteq 2^{<\omega}$ is a tree, it is \wedge -closed, σ is at most 2-branching. Since $T \in \mathcal{S}_\omega(2^{<\omega})$, every node in T is 2-branching. Then σ has two extensions $\tau_0, \tau_1 \in T(\ell_{i+1})$ such that $\tau_0 \wedge \tau_1 = \sigma$. By maximality of E , σ is 2-branching in E . Thus $E \in \mathcal{S}_{2n-1}(T)$. \square

THEOREM 5.22 (ACA₀). *Let \mathbb{X} be a countable DLO Joyce structure, and \mathbb{F} be a finite Joyce structure. Then, the big Ramsey number of \mathbb{F} in \mathbb{X} is 1.*

PROOF. Let X be a countable coded DLO Joyce order and F be a finite coded Joyce order of size n . Fix a coloring $f : \binom{X}{F} \rightarrow k$. Here, $\binom{X}{F}$ denotes all the subcopies of F in X .

Let $h : 2^{<\omega} \rightarrow X$ be a Joyce order diagonalization, which exists by Corollary 5.20. Let $g : \mathcal{S}_{2n-1}(2^{<\omega}) \rightarrow k$ be defined for every $E \in \mathcal{S}_{2n-1}(2^{<\omega})$ by $g(E) = f(h(H))$ where $H \subseteq E$ is the unique element coded Joyce order isomorphic to F , if it exists. Otherwise let $g(E) = 0$. This coloring is well-defined by Lemma 5.21.

By Milliken's tree theorem for height $2n-1$, there is a strong subtree $S \in \mathcal{S}_\omega(2^{<\omega})$ such that g restricted to $\mathcal{S}_{2n-1}(S)$ is monochromatic for some color $i < k$. In particular, by Lemma 5.21, for every coded Joyce order $H \subseteq S$ isomorphic to F , there is some $E \in \mathcal{S}_{2n-1}(S)$ containing H , and $g(E) = f(h(H)) = i$.

Since $S \in \mathcal{S}_\omega(2^{<\omega})$, there is an injective function $\phi : 2^{<\omega} \rightarrow S$ such that $\phi[X]$ is a coded Joyce order isomorphic to X . In particular, since h is a Joyce diagonalization, $Y = h[\phi[X]]$ is a DLO coded Joyce order isomorphic to X , hence a subcopy of X . Note that Y is a coded Joyce order since it is a subset of X which is a coded Joyce order.

We claim that f restricted to $\binom{Y}{F}$ is monochromatic for color i . Let \hat{H} be a copy of F in $Y = h[\phi[X]]$. Let $H \subseteq \phi[X]$ be such that $h[H] = \hat{H}$. In particular since $\phi[X]$ is a coded Joyce order, so is H , so since h is a Joyce

order diagonalization, $\hat{H} = h[H]$ is a coded Joyce order isomorphic to H . In other words, H is a copy of F in $\phi[X] \subseteq S$, so H is a copy of F in S . By Lemma 5.21, there is some $E \in \mathcal{S}_{2n-1}(S)$ containing H , and by definition of g , $g(E) = f(h(H))$. By choice of S , g restricted to $\mathcal{S}_{2n-1}(S)$ is homogeneous for color i , so $g(E) = f(h[H]) = i$, so $f(\hat{H}) = i$. \square

STATEMENT 5.23 (Joyce Devlin's theorem for n -tuples and ℓ colors). $\text{JDT}_{k,\ell}^n$ is the statement: "For any Joyce structure \mathbb{X} and coloring $f : [\mathbb{X}]^n \rightarrow k$, there exists a strong subcopy of \mathbb{X} such that f uses at most ℓ colors".

COROLLARY 5.24 (Tight bounds on Joyce Devlin's theorem). *For any n , $(\forall k)\text{JDT}_{k,\ell}^n$ holds, ℓ being the number of Joyce orders with n elements, and this bound is tight.*

PROOF. Let ℓ be the number of Joyce order structures with n elements. Let $F_0, \dots, F_{\ell-1}$ be a finite enumeration of all the finite coded Joyce orders of size n .

We first prove that $(\forall k)\text{JDT}_{k,\ell}^n$ holds. Fix a coloring $f : [X]^n \rightarrow k$ for some countable DLO Joyce structure $(X, <, \mathbf{R})$. By Theorem 5.22, build a finite decreasing sequence of subsets $X = X_0 \supseteq X_1 \supseteq \dots \supseteq X_\ell$ of X such that for every $s < \ell$:

- (1) $(X_{s+1}, <, \mathbf{R})$ is a subcopy of $(X_s, <, \mathbf{R})$;
- (2) every copy of F_s in $(X_{s+1}, <, \mathbf{R})$ is monochromatic for f for some color $i_s < k$.

The Joyce structure $(X_\ell, <, \mathbf{R})$ is a subcopy of $(X, <, \mathbf{R})$. Moreover, for every $E \in [X_\ell]^n$, $(E, <, \mathbf{R})$ is isomorphic to F_s for some $s < \ell$, so $f(E) = i_s$. It follows that $f[X_\ell]^n \subseteq \{i_s : s < \ell\}$, hence $|f[X_\ell]^n| \leq \ell$.

We now show that the bound is tight. Let $f : [X]^n \rightarrow k$ be defined by $f(E) = s$ for the unique $s < \ell$ such that $(E, <, \mathbf{R})$ is isomorphic to F_s . Let $(Y, <, \mathbf{R})$ be a subcopy of $(X, <, \mathbf{R})$. In particular, $(Y, <, \mathbf{R})$ is a DLO Joyce structure, so by Theorem 5.16, for every $s < \ell$, there is an embedding of F_s into $(Y, <, \mathbf{R})$. Therefore, $|f[Y]^n| \geq \ell$. \square

It is clear that Joyce Devlin's theorem for n -tuples and ℓ colors implies Devlin's theorem for n -tuples and ℓ colors: indeed, by the existence of a DLO Joyce structure and computable categoricity of dense linear orders without endpoints, any such order can be turned into a DLO Joyce structure (see Corollary 5.9). The following theorem shows the converse:

THEOREM 5.25 (RCA_0). *Let $\mathbb{X} = (X, <, \mathbf{R})$ be a DLO Joyce structure. Let $\mathbb{X}' = (X', <)$ be an isomorphic subcopy of $(X, <)$, that is, a dense linear order with no endpoints. Then, there exists a subcopy $(X'', <)$ of $(X', <)$ such that $(X'', <, \mathbf{R})$ is a subcopy of \mathbb{X} .*

PROOF. The structure $\hat{\mathbb{X}}' = (X', <, \mathbf{R})$ is a DLO Joyce structure, even if it might not be isomorphic to \mathbb{X} . By Theorem 5.16, there exists an embedding of \mathbb{X} into $\hat{\mathbb{X}}'$. The image of the embedding is \mathbb{X}'' . \square

COROLLARY 5.26 (RCA₀). *Devlin's theorem for n -tuples and ℓ colors implies Joyce Devlin's theorem for n -tuples and ℓ colors.*

COROLLARY 5.27 (RCA₀). *The tight bound for Devlin's theorem and Joyce Devlin's theorem for n elements are the same, that is, the number of Joyce structures with n elements, or the number of Joyce trees with n leaves, or the odd tangent number of n .*

PROOF. Let b_0 and b_1 be the tight bound for Devlin's theorem and Joyce Devlin's theorem for n elements, respectively.

We first claim that $b_0 \leq b_1$. Let $(X, <)$ be a dense linear order with no endpoints. By Corollary 5.9, one can enrich this order with a relation R so that $(X, <, R)$ is a DLO Joyce structure. Let $f : [X]^n \rightarrow k$ be a coloring. By choice of b_1 , there is a Joyce subcopy $(Y, <, R)$ of $(X, <, R)$ such that $|f[Y]^n| \leq b_1$. In particular, $(Y, <)$ is a subcopy of $(X, <)$ so $b_0 \leq b_1$.

We then claim that $b_1 \leq b_0$. Let $(X, <, R)$ be a DLO Joyce structure. Let $f : [X]^n \rightarrow k$ be a coloring. By choice of b_0 , there is a subcopy $(Y, <)$ of $(X, <)$ such that $|f[Y]^n| \leq b_0$. By Theorem 5.25, there is a subcopy $(Z, <, R)$ of $(Y, <)$ such that $(Z, <, R)$ is a Joyce subcopy of $(X, <, R)$. In particular, $|f[Z]^n| \leq b_0$. Thus $b_1 \leq b_0$.

It follows that $b_0 = b_1$. Moreover, by Corollary 5.24, this tight bound is the number of Joyce structures with n elements, that is, the odd tangent number of n (see [48, p. 147]). \square

5.3. Lower bounds on Devlin's theorem

A coloring that witness the need for 2 colors for Devlin's theorem for pairs is the coloring f_0 defined as follows. Let $(q_n)_{n \in \mathbb{N}}$ be an enumeration of the rationals, and define $f_0 : [\mathbb{Q}]^2 \rightarrow 2$ by letting $f_0(q_n, q_m) = 0$ if $q_n < q_m \iff n < m$, and $f_0(q_n, q_m) = 1$ otherwise. Now every subset $S \subseteq \mathbb{Q}$ of order-type \mathbb{Q} (or even \mathbb{Z}) must contain pairs of both colors under f_0 , as every element of a dense linear order has infinitely many element both below it and above it.

Recall the ordering $<_{\mathbb{Q}}$ on $2^{<\omega}$ from Definition 5.7. An explicit embedding of $<_{\mathbb{Q}}$ into \mathbb{Q} is given by the following function: $\sigma \mapsto \sum_{i < |\sigma|} (\sigma(i) - \frac{1}{2})2^{-i}$. Thus, the i th bit of σ contributes to the sum either -2^{-i-1} or 2^{-i-1} , depending as it is 0 or 1.

THEOREM 5.28. *There is a computable instance of $DT_{4,3}^2$ all of whose solutions compute the halting set.*

PROOF. Recall the order $<_{\mathbb{Q}}$ from Definition 5.7, and that $(\mathbb{Q}, <) \cong (2^{<\omega}, <_{\mathbb{Q}})$ via a computable bijection. Therefore, the rationals will now be considered as finite strings.

Let $f_{<_{\mathbb{Q}}} : [2^{<\omega}]^2 \rightarrow 2$ be the function such that $f_{<_{\mathbb{Q}}}(\sigma, \tau) = 1$ if and only if $|\sigma| < |\tau| \iff \sigma <_{\mathbb{Q}} \tau$. Any dense (in the sense of $<_{\mathbb{Q}}$) subset of $2^{<\omega}$ must contain a pair with both 0, and a pair with color 1. Let also $f_J : [\mathbb{N}]^3 \rightarrow 2$ be such that for any $x < y < z$, $f_J(x, y, z) = 1$ if and only if $K_y \upharpoonright x = K_z \upharpoonright x$,

where K is a complete Σ_1^0 set with fixed computable enumeration $(K_s)_{s \in \omega}$. (The function f_J was devised by Jockusch [23, Theorem 5.7] to show the analogue of the present theorem for Ramsey's theorem for triples.)

The function of interest for us is the product function $f = f_{<_{\mathbb{Q}}} \times f_J : (\sigma, \tau) \mapsto (f_{<_{\mathbb{Q}}}(\sigma, \tau), f_J(|\sigma \wedge \tau|, |\sigma|, |\tau|))$. This is a 4-coloring, so by $\text{DT}_{4,3}^2$ let $S \subseteq 2^{<\omega}$ be a dense linear ordering for $<_{\mathbb{Q}}$ such that f uses at most three colors on $[S]^2$. Suppose for instance that for some $c \in 2$ and for every $\sigma, \tau \in S$, we have $f(\sigma, \tau) \neq (1, 1 - c)$. (The case where the color $(0, 1 - c)$ is avoided is symmetric). This means that any $\sigma_0 <_{\mathbb{Q}} \sigma_1$ in S with $|\sigma_0| < |\sigma_1|$ must have color c under f_J .

The remainder of the proof consists of two parts. The first is the proof that c must be 1, and the second is an argument to show how to compute K from S . The main ingredient will be the fact that for every $n \in \mathbb{N}$, we can find arbitrarily long strings σ and τ in S with $|\sigma \wedge \tau| > n$. This is depicted in Figure 5.2.

Given two strings $\sigma <_{\mathbb{Q}} \tau$, define $]\sigma, \tau[= \{\rho \in 2^{<\omega} : \sigma <_{\mathbb{Q}} \rho <_{\mathbb{Q}} \tau\}$. Note that if $I \subseteq 2^{<\omega}$ is a dense linear ordering without endpoints under $<_{\mathbb{Q}}$, then so is $I \cap]\sigma, \tau[$. Also, note that if $\xi, \rho \in]\sigma, \tau[$ then $\xi \wedge \rho = \sigma \wedge \tau$.

FACT 5.29. If $I \subseteq 2^{<\omega}$ is a dense linear ordering without endpoints under $<_{\mathbb{Q}}$, then I contains a pair of incompatible strings, σ and τ . Moreover, for every $n \in \mathbb{N}$, we can find such σ and τ so that $|\sigma \wedge \tau| > n$.

PROOF. Fix $n \in \mathbb{N}$. As I is infinite but 2^n is finite, there exist $\rho_0, \rho_1 \in I$ such that $\rho_0 \upharpoonright n = \rho_1 \upharpoonright n$. If ρ_0 and ρ_1 are incompatible, then these can serve as σ and τ . So suppose otherwise, say $\rho_0 <_{\mathbb{Q}} \rho_1$. Fix any $\xi \in I \cap]\rho_0, \rho_1[$. Since $I \cap]\rho_0, \rho_1[$ is a dense linear order without endpoints, there are infinitely many $\sigma, \tau \in I \cap]\rho_0, \rho_1[$ with $\sigma <_{\mathbb{Q}} \xi <_{\mathbb{Q}} \tau$, so these can be chosen so that $|\sigma| > |\xi|$ and $|\tau| > |\xi|$. But now, if σ and τ were compatible, then by definition of $<_{\mathbb{Q}}$ they would both be above or both below ξ , a contradiction. Thus, σ and τ are incomparable elements of I . Furthermore, since $\rho_0 <_{\mathbb{Q}} \sigma <_{\mathbb{Q}} \tau <_{\mathbb{Q}} \rho_1$, we have $\sigma \upharpoonright n = \tau \upharpoonright n$, so $|\sigma \wedge \tau| > n$. \square

FACT 5.30. If $I \subseteq 2^{<\omega}$ is a dense linear ordering without endpoints under $<_{\mathbb{Q}}$, then for every $n \in \mathbb{N}$ there exists four pairwise incompatible strings $\alpha_j^i \in I$ for $i, j \in 2$ such that $\alpha_0^0 <_{\mathbb{Q}} \alpha_1^0 <_{\mathbb{Q}} \alpha_0^1 <_{\mathbb{Q}} \alpha_1^1$, the strings $\alpha_0^0 \wedge \alpha_1^0$ and $\alpha_0^1 \wedge \alpha_1^1$ are incompatible, and $|\alpha_0^0 \wedge \alpha_1^0 \wedge \alpha_0^1 \wedge \alpha_1^1| > n$. (See Figure 5.2.)

PROOF. Fix $n \in \mathbb{N}$. First, suppose that whenever $\rho_0, \rho_1 \in I$ satisfy $|\rho_0 \wedge \rho_1| > n$ then they are incompatible. Since I is infinite and 2^n is finite, we can then pick $\alpha_0^0 <_{\mathbb{Q}} \alpha_1^0 <_{\mathbb{Q}} \alpha_0^1 <_{\mathbb{Q}} \alpha_1^1$ in I with $|\alpha_0^0 \wedge \alpha_1^0 \wedge \alpha_0^1 \wedge \alpha_1^1| > n$. Then by assumption, all the α_j^i must be pairwise incompatible, as must $\alpha_0^0 \wedge \alpha_1^0$ and $\alpha_0^1 \wedge \alpha_1^1$.

So suppose otherwise, and fix $\rho_0 <_{\mathbb{Q}} \rho_1$ with $|\rho_0 \wedge \rho_1| > n$. Fix $\gamma \in S \cap]\rho_0, \rho_1[$ (represented in grey in Figure 5.2). As $S \cap]\rho_0, \gamma[$ and $S \cap]\gamma, \rho_1[$ are two dense linear orderings without endpoints, we can apply the preceding fact

to find incompatible $\alpha_0^0, \alpha_1^0 \in S \cap]\rho_0, \gamma[$ and incompatible $\alpha_0^1, \alpha_1^1 \in S \cap]\gamma, \rho_1[$ with $|\alpha_0^0 \wedge \alpha_1^0| > |\gamma|$ and $|\alpha_0^1 \wedge \alpha_1^1| > |\gamma|$.

Since $|\alpha_0^i \wedge \alpha_1^i| > |\gamma|$ for each $i \in 2$, we have $|\alpha_j^i| > |\gamma|$ for all $i, j \in 2$. Hence, α_j^0 and α_j^1 are incompatible for each $j \in 2$, being on opposite sides of γ under $<_{\mathbb{Q}}$.

Since $\alpha_0^0, \alpha_1^0 <_{\mathbb{Q}} \gamma <_{\mathbb{Q}} \alpha_0^1, \alpha_1^1$, we have necessarily $\alpha_0^0 \wedge \alpha_1^0 \leq_{\mathbb{Q}} \gamma \leq_{\mathbb{Q}} \alpha_0^1, \alpha_1^1$, but since $|\alpha_0^i \wedge \alpha_1^i| > |\gamma|$ for each $i \in 2$ these inequalities must be strict. It follows that $\alpha_0^0 \wedge \alpha_1^0$ and $\alpha_0^1 \wedge \alpha_1^1$ are incompatible, as desired.

Finally, as $\rho_0 <_{\mathbb{Q}} \alpha_j^i <_{\mathbb{Q}} \rho_1$ for all $i, j \in 2$, we have $\rho_0 \leq_{\mathbb{Q}} \alpha_0^0 \wedge \alpha_1^0 \wedge \alpha_0^1 \wedge \alpha_1^1 \leq_{\mathbb{Q}} \rho_1$, meaning that $\alpha_0^0 \wedge \alpha_1^0 \wedge \alpha_0^1 \wedge \alpha_1^1 = \rho_0 \wedge \rho_1$ and hence $|\alpha_0^0 \wedge \alpha_1^0 \wedge \alpha_0^1 \wedge \alpha_1^1| > n$. \square

We now use Fact 5.30 to prove that the color 1 for f_J cannot be avoided. Fix any n , and find $\alpha_j^i \in S$ for $i, j \in 2$ as in Fact 5.30. Fix l such that $K_l \upharpoonright N = K \upharpoonright N$, where $N = |\alpha_0^0 \wedge \alpha_1^0 \wedge \alpha_0^1 \wedge \alpha_1^1|$. Pick $\sigma_n \in S \cap]\alpha_0^0, \alpha_1^0[$ and $\sigma_m \in S \cap]\alpha_0^1, \alpha_1^1[$ such that $n < m$ and $|\sigma_n|, |\sigma_m| > l$. Now, as $\sigma_n \wedge \sigma_m = \alpha_0^0 \wedge \alpha_1^0 \wedge \alpha_0^1 \wedge \alpha_1^1$, we have $f_J(|\sigma_n \wedge \sigma_m|, |\sigma_n|, |\sigma_m|) = 1$ as the approximation for $K \upharpoonright N$ does not change after stage l . Therefore, the product coloring f assigns (σ_n, σ_m) the color $(1, 1)$. In particular, $c = 1$, as desired.

It remains to show that K is S -computable. Given n , we uniformly compute $K \upharpoonright n$ from S . First, search for four strings $(\alpha_j^i)_{i,j \in 2}$ in S satisfying Fact 5.30, which will be found as they exist. Then, output $K_{|\alpha_0^0|} \upharpoonright n$. Indeed, if it were the case that $K_{|\alpha_0^0|} \upharpoonright n \neq K \upharpoonright n$, then it would also be true that $K_{|\alpha_0^0|} \upharpoonright n \neq K_l \upharpoonright n$ for all sufficiently large l . But then we would have $f_J(\alpha_0^0, \sigma) = 0$ for any $\sigma \in S \cap]\alpha_0^1, \alpha_1^1[$ with $|\sigma|$ sufficiently big, contradicting that fact that $c = 1$. \square

COROLLARY 5.31. *Over RCA_0 , $\text{DT}_{4,3}^2$ implies ACA.*

THEOREM 5.32. *For every $k, \ell \geq 1$, $\text{RT}_{k,\ell}^2 \leq_c \text{DT}_{2k,2\ell+1}^2$.*

PROOF. Let $f : [\omega]^2 \rightarrow k$ be an instance of $\text{RT}_{k,\ell}^2$. Let $\mathbb{Q} = \{x_0, x_1, \dots\}$ be a computable enumeration of all the rationals. Define $g : [\mathbb{Q}]^2 \rightarrow 2k$ for every pair $\{x_p, x_q\} \in [\mathbb{Q}]^2$ by $g(x_p, x_q) = (0, f(p, q))$ if $x_p <_{\mathbb{Q}} x_q$ and $g(x_p, x_q) = (1, f(p, q))$ otherwise. Let $U \subseteq \mathbb{Q}$ be a solution to the instance g of $\text{DT}_{2k,2\ell+1}^2$, that is, $(U, <_{\mathbb{Q}})$ is a DLO order and $|g[U]^2| \leq 2\ell + 1$. Let $d < 2$ and $I \subseteq \{0, \dots, 2k - 1\}$ with $|I| \leq \ell$ be such that $\{i : (d, i) \in g[U]^2\} \subseteq I$. Say $d = 0$, the other case is symmetrical. Build U -computably an infinite sequence $x_{p_0} <_{\mathbb{Q}} x_{p_1} <_{\mathbb{Q}} \dots$ such that $p_n < p_{n+1}$. Such a sequence exists since $(U, <_{\mathbb{Q}})$ has no endpoints. For every $s < t \in \omega$, $f(x_{p_s}, x_{p_t}) = (0, f(p_s, p_t))$. Since $\{i : (d, i) \in g[U]^2\} \subseteq I$, $f(p_s, p_t) \in I$. Thus, letting $H = \{p_s : s \in \omega\}$, $f[H]^2 \subseteq I$ so $|f[H]^2| \leq \ell$. \square

We now give a better lower bound to Devlin's theorem for pairs by constructing a computable instance of it with no Σ_3^0 solution.

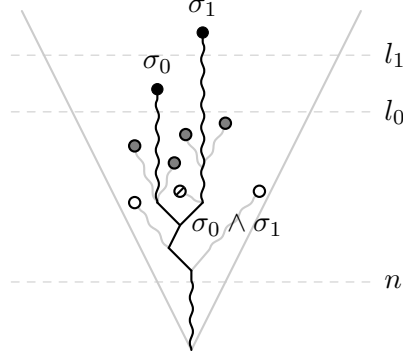

FIGURE 5.2. Finding σ_0 and σ_1 above l_0 and l_1 , with a meet above n . The nodes ρ_0 and ρ_1 from Fact 5.29 are represented as hollow nodes, the node γ from the proof of Fact 5.30 is represented by a slashed node, and the nodes α_j^i from Fact 5.30 are in grey.

DEFINITION 5.33. A set $H \subseteq \mathbb{N}$ is *thin* for a $\sigma \in k^{<\mathbb{N}}$ if there exists some $i < 2$ such that for all $n \in H$, $n < |\sigma| \implies \sigma(n) \neq i$. It is *thin* for a tree $T \subseteq 2^{<\mathbb{N}}$ if the tree $\{\sigma \in T : H \text{ is thin for } \sigma\}$ is infinite.

Whenever $k = 2$, a thin set is also called *homogeneous*.

DEFINITION 5.34. A Δ_2^0 *approximation* of a sequence $\sigma \in k^{\leq \omega}$ is a sequence $(\sigma_s)_{s \in \mathbb{N}}$ of finite sequence such that for every n , $\lim \sigma_s(n)$ exists and has value $\sigma(n)$.

A Δ_3^0 *approximation* of a sequence σ is a sequence $(\sigma_{s,t})_{s,t \in \mathbb{N}}$ such that for every $s \in \mathbb{N}$, $(\sigma_{s,t})_{t \in \mathbb{N}}$ is a Δ_2^0 approximation of a sequence σ_s , and $(\sigma_s)_{s \in \mathbb{N}}$ is a Δ_2^0 approximation of σ .

THEOREM 5.35. Let F be a finite Joyce order with two elements, \mathbb{J} be a DLO Joyce structure and k be an integer. For every Δ_3^0 approximation of an infinite tree $T \subseteq k^{<\infty}$, there exists a coloring $f : \binom{\mathbb{J}}{F} \rightarrow k$ such that for every DLO Joyce suborder $S \subseteq \mathbb{J}$, if f avoids 1 color in $\binom{S}{F}$ then S computes a thin set for T .

PROOF. We can always suppose \mathbb{J} is a coded Joyce order. Let m, M be such that $\{m; M\} = F$, and $|m| < |M|$. Let $(T_{s,t})_{s,t \in \mathbb{N}}$ be a Δ_3^0 approximation of an infinite tree, that is for every $s \in \mathbb{N}$, $T_s = \lim_t T_{s,t}$ exists and $T = \lim_s T_s$ exists. Let $P_{s,t}$ be the leftmost path of $T_{s,t}$ of length s . Note that $P_s = \lim_t P_{s,t}$ is the leftmost path of T_s of length s , and $P = \lim_s P_s$ is the leftmost path of T . If $\{\sigma, \tau\} \in \binom{\mathbb{J}}{F}$ with $|\sigma| > |\tau|$, define

$$f(\sigma, \tau) = P_{|\sigma|, |\tau|}(|\sigma \wedge \tau|),$$

a computable coloring of $\binom{\mathbb{J}}{F}$ in k colors.

Now, suppose that $S \subseteq 2^{<\omega}$ is of order-type \mathbb{Q} and such that $\binom{S}{F}$ avoids some color $i < k$ for f . The claim is that the set

$$H = \{|a \wedge c| : (\exists a, b, c, d \in S)[a <_{\text{lex}} b <_{\text{lex}} c <_{\text{lex}} d \wedge |a \wedge c| < |a \wedge b|, |c \wedge d|]\}$$

is thin for P , and thus for T .

Here, we suppose $m <_{\text{lex}} M$, so that if $x, y \in \mathbb{J}$ satisfies $|x| < |y|$, then $\{x, y\} \in \binom{\mathbb{J}}{F}$ iff $x <_{\text{lex}} y$. Let $\ell \in H$, fix a, b, c, d witnessing it. Let $s_0 > \ell$ be such that $P_s(\ell)$ has settled for every $s \geq s_0$. Let $\sigma \in S$ in the interval with bounds a and b such that $s_1 = |\sigma| \geq s_0$, which exists as there are infinitely many elements of S in this interval. Let t_0 be such that $P_{s_1, t_0}(\ell)$ has settled for every $t \geq t_0$, and let $\tau \in S$ be in the interval with bounds c and d with $t_1 = |\tau| \geq \max(t_0, \ell, s_1)$. Then, $\{\sigma, \tau\} \in \binom{S}{F}$ and $f_P(\sigma, \tau) = P_{s_1, t_1}(\ell) \neq i$ as $\binom{S}{F}$ avoids color i . By our choice of t_1 , $P_{s_1, t_1}(\ell) = P_{s_1}(\ell)$, and by our choice of s_1 , $P_{s_1}(\ell) = P(\ell) \neq i$, that is, H is thin for P , and thus for T .

If $m >_{\text{lex}} M$, we do the same argument, but we take σ in the interval with bounds c and d , and τ in the interval with bound a and b , to get the same conclusion.

We proved that H is thin for T . As H is c.e. in S , it contains an infinite computable subset, which is thin for T as well. \square

COROLLARY 5.36. *Let k be an integer. For every Δ_3^0 approximation of an infinite tree $T \subseteq k^{<\omega}$, there exists a coloring $f : [\mathbb{Q}]^2 \rightarrow 2k$ such that for every DLO Joyce suborder $S \subseteq \mathbb{J}$, if f takes only $2k - 1$ color on $[S]^2$ then S computes a thin set for T .*

PROOF. Let F_0 and F_1 be the two Joyce structure with two elements. Let f_0 and f_1 be given by Theorem 5.35 for F_0 and F_1 . Define $f : \mathbb{Q} \rightarrow 2k$ by enriching \mathbb{Q} to a Joyce order, and if $\sigma, \tau \in \mathbb{Q}$, then $f(\sigma, \tau) = (i, f_i(\sigma, \tau))$ if and only if $\{\sigma, \tau\}$ is isomorphic to F_i .

If $S \subseteq \mathbb{Q}$ is an isomorphic substructure such that f takes at most $2k - 1$ color on $[S]$, then let (i, j) with $i < 2$ and $j < k$ be an avoided color. Then, f_i avoids color j on $\binom{S}{F_i}$, and by our choice of f_i , S computes a thin set for T . \square

DEFINITION 5.37. A function $f : \omega \rightarrow \omega$ is *DNC relative to X* if for every e , $f(e) \neq \Phi_e^X(e)$. Here, $f(e)$ can be any value if $\Phi_e^X(e) \uparrow$. A Turing degree is DNC relative to X if it computes such a function.

LEMMA 5.38. *For every $k \geq 2$ and set X , there exists an X -computable tree $T \subseteq k^{<\mathbb{N}}$ such that every infinite set thin for T is of DNC degree relative to X .*

PROOF. Let $T \subseteq k^{<\mathbb{N}}$ be an infinite X -computable tree such that every infinite path is a Martin-Löf random relative to X in base k . Let H be an infinite set thin for T . In particular, there is some path $P \in [T]$ and some color $i < k$ such that $H \subseteq \{x : P(x) \neq i\}$. Let Z be the Martin-Löf random P in base 2. The set H computes an infinite subset of Z or of \bar{Z} , hence is of DNC degree relative to X . \square

COROLLARY 5.39. *For every $\ell \geq 2$, there exists a computable instance of $(\forall k)DT_{k,\ell}^2$ such that every solution is of DNC degree relative to \emptyset'' .*

PROOF. Fix $\ell \geq 2$. By Lemma 5.38 relativized to \emptyset'' , there exists a computable Δ_3^0 -approximation of a tree $T \subseteq \ell^{<\mathbb{N}}$ such that every infinite set thin for T is of DNC degree relative to \emptyset'' . By Theorem 5.35, let f be a computable instance of $DT_{2\ell,\ell}^2$ such that every solution compute a set H thin for T . Then every solution is of DNC degree relative to \emptyset'' . \square

LEMMA 5.40. *For every X -c.e. dense linear order with no endpoints $(D, <_D)$, there is an X -computable subset $S \subseteq D$ such that $(S, <_D)$ is a sub-copy of $(D, <_D)$.*

PROOF. We build an X -computable $<_{\mathbb{N}}$ -increasing sequence

$$x_0 <_{\mathbb{N}} x_1 <_{\mathbb{N}} \dots$$

of elements of D such that letting $S = \{x_n : n \in \mathbb{N}\}$, $(S, <_D)$ is a dense linear order without endpoints. Start with $x_0 \in D$ being any element. Having defined $F = \{x_0 <_{\mathbb{N}} x_1, \dots <_{\mathbb{N}} x_n\}$, consider a minimal interval in $F \cup \{-\infty, +\infty\}$ with respect to $<_D$, that is, an interval (a, b) with $a <_D b \in F \cup \{-\infty, +\infty\}$ such that $(a, b) \cap F = \emptyset$. Then wait until some element x_{n+1} appears in $W \cap (a, b)$ with $x_{n+1} >_{\mathbb{N}} x_n$. Such element must be found since, as $(D, <_D)$ is a DLO with no endpoints, there are infinitely many elements in $W \cap (a, b)$, so elements of arbitrary large value with respect to $<_{\mathbb{N}}$. By choosing the minimal interval in an appropriate way, we can ensure that $(S, <_D)$ is a DLO with no endpoints. Since D is X -c.e., searching for x_{n+1} is done X -computably, so $S \leq_T X$. \square

COROLLARY 5.41. *For every $\ell \geq 2$, there exists a computable instance of $(\forall k)DT_{k,\ell}^2$ with no Σ_3^0 solution.*

PROOF. By Corollary 5.39, there is a computable instance $f : [\mathbb{Q}]^2 \rightarrow k$ of $(\forall k)DT_{k,\ell}^2$ such that every solution is of DNC degree relative to \emptyset'' . Suppose for the contradiction that there is a Σ_3^0 sub-copy $(U, <_{\mathbb{Q}})$ of $(\mathbb{Q}, <_{\mathbb{Q}})$ such that $|f[U]^2| \leq \ell$. By Lemma 5.40, there is a Δ_3^0 subset $H \subseteq U$ such that $(H, <_{\mathbb{Q}})$ is a sub-copy of $(\mathbb{Q}, <_{\mathbb{Q}})$. Since H is of DNC degree relative to \emptyset'' , it computes a function $f : \omega \rightarrow \omega$ such that for all e , $f(e) \neq \Phi_e^{\emptyset''}(e)$. Since H is Δ_3^0 , so is f , hence there is some e such that $\Phi_e^{\emptyset''} = f$. But then $f(e) = \Phi_e^{\emptyset''}(e)$, contradiction. \square

5.4. Above the big Ramsey number of Devlin's theorem

In the case of Devlin's theorem for pairs, the existence of the big Ramsey number implies ACA_0 . By Corollary 5.31, this is also the case when weakening the statement by allowing 3 instead of 2 colors in the solution. We shall now conclude the chapter about Devlin's theorem by proving that this bound is tight, in that the statement $(\forall k)DT_{k,4}^2$ does not imply ACA_0 over RCA_0 . The proof consists essentially of replacing the use of Milliken's

tree theorem for height 3 by the statement $(\forall k)\text{PMTT}_{k,2}^3$ which admits cone avoidance by Theorem 4.28. The cost of this substitution is an increase in the number of colors allowed in the solution.

THEOREM 5.42 ($\text{RCA}_0 \wedge (\forall k)\text{PMTT}_{k,2}^3$). *Let X be a DLO Joyce structure and F be a Joyce structure of size 2. Then for every $k \in \omega$ and every coloring $f : \binom{X}{F} \rightarrow k$, there is a subcopy Y of X such that f uses at most 2 colors over $\binom{Y}{F}$.*

PROOF. The proof is exactly the same as the one of Theorem 5.22, but replacing an application of Milliken's tree theorem for height 3 by $(\forall k)\text{PMTT}_{k,2}^3$. \square

THEOREM 5.43. $(\forall k)\text{PMTT}_{k,2}^3$ implies $(\forall k)\text{JDT}_{k,4}^2$ over RCA_0 .

PROOF. Let F_0 and F_1 be the two coded Joyce orders of size 2. Let X be a coded DLO Joyce order and let $f : [X]^2 \rightarrow k$ be a coloring. By Theorem 5.42, there is a subcopy X_0 of X such that f uses at most 2 colors i_0, i_1 over $\binom{X_0}{F_0}$. Again by Theorem 5.42, there is a subcopy X_1 of X_0 such that f uses at most 2 colors j_0, j_1 over $\binom{X_1}{F_1}$. We claim that $f[X_1]^2 \subseteq \{i_0, i_1, j_0, j_1\}$. Let $E \in [X_1]^2$. In particular, E is isomorphic to F_0 or F_1 . In the first case, $f(E) \in \{i_0, i_1\}$ and in the second case, $f(E) \in \{j_0, j_1\}$. Thus X_1 is a subcopy of X such that $|f[X]^2| \leq 4$. \square

COROLLARY 5.44. $(\forall k)\text{JDT}_{k,4}^2$ admits cone avoidance.

PROOF. By Theorem 4.28, $(\forall k)\text{PMTT}_{k,2}^3$ admits cone avoidance hence so does $(\forall k)\text{JDT}_{k,4}^2$ by Theorem 5.43. \square

COROLLARY 5.45. $(\forall k)\text{JDT}_{k,4}^2$ does not imply ACA_0 over RCA_0 .

PROOF. By Theorem 4.28, $(\forall k)\text{PMTT}_{k,2}^3$ admits cone avoidance, hence there is a model M_c of $\text{RCA}_0 \wedge (\forall k)\text{PMTT}_{k,2}^3$ which is not a model of ACA_0 . In particular, $M_c \models (\forall k)\text{JDT}_{k,4}^2$ by Theorem 5.43. \square

5.5. The Erdős Rado theorem

Erdős and Rado proved that it is always possible to obtain either a copy of \mathbb{Q} of one color, or else an infinite homogeneous set (in the sense of Ramsey's theorem) of the other color.

THEOREM 5.46 (Erdős Rado theorem). *For every $f : [\mathbb{Q}]^2 \rightarrow 2$, there exists a subset $S \subseteq \mathbb{Q}$ such that either S is infinite and f -homogeneous of color 0, or S is of order-type \mathbb{Q} and f -homogeneous of color 1.*

STATEMENT 5.47. ER^2 is the statement denoting the Erdős Rado theorem.

This statement was studied by [5, 16, 15] in the setting of reverse mathematics. One would expect it to be a consequence of Devlin's theorem by the optimality of the bounds noted above. We give a direct combinatorial proof of ER^2 from Devlin's theorem for pairs of rationals.

THEOREM 5.48. $\text{DT}_{4,2}^2$ implies ER^2 .

PROOF. Let $f : [\mathbb{Q}]^2 \rightarrow 2$ be a coloring of pairs of rationals, regarded as a given instance of ER^2 . Let f_0 be the 2-coloring of $[\mathbb{Q}]^2$ witnessing the fact that big Ramsey degree of the pairs of rationals is 2, that is, f_0 is such that for every sub-copy S of the rationals, $|f_0[S]^2| = 2$. An explicit construction of f_0 is given at the start of Section 5.3.

Apply $\text{DT}_{4,2}^2$ to the 4-coloring $f \times f_0 : (q, r) \mapsto (f(q, r), f_0(q, r))$ to get a subcopy of the rationals S such that $f \times f_0$ uses at most $t_{\text{DT}}(2) = 2$ colors on $[S]^2$. As $[S]^2$ must have two colors for f_0 , the two colors of $[S]^2$ for $f \times f_0$ must be of the form $(c_0, 0)$ and $(c_1, 1)$. The rest of the proof is split into 3 cases.

Case 1: $c_0 = c_1 = 1$. In this case, $[S]^2$ is monochromatic with color 1 for f , and since S has order-type \mathbb{Q} it is a solution to f as an instance ER^2 .

Case 2: $c_0 = 0$ and $c_1 = 1$. Then $f_0(q, r) = 0$ implies $f(q, r) = 0$, for all $q, r \in S$. We build an infinite set $T = \{q_{n_i} : i \in \mathbb{N}\}$ such that $[T]^2$ is monochromatic for f_0 with color 0, and therefore also for f with color 0. To this end, we build an increasing sequence of rationals $(q_{n_i})_{i \in \mathbb{N}}$ in S , such that $(n_i)_{i \in \mathbb{N}}$ is also increasing. Fix any $q_{n_0} \in S$, and suppose q_{n_i} has been defined. As there exists infinitely many rationals in S above q_{n_i} , there exists $n_{i+1} > n_i$ such that $q_{n_{i+1}} > q_{n_i}$ and $q_{n_{i+1}} \in S$. This completes the construction. Now, T is an infinite f -homogeneous set with color 0, and hence a solution to f as an instance of ER^2 .

Case 3: $c_1 = 0$ and $c_0 = 0$. Symmetric to Case 2. □

However, ER^2 admits cone avoidance. As a warm-up before the proof of this result, we prove the following:

LEMMA 5.49. Let $f_J : [2^{<\omega}]^2 \rightarrow 2$ be such that $f_J(\sigma, \tau) = 1$ iff $\emptyset' \upharpoonright [\sigma] \upharpoonright |\sigma \wedge \tau| = \emptyset' \upharpoonright [\tau] \upharpoonright |\sigma \wedge \tau|$. Then, there exists two computable infinite sets X_0 and X_1 such that $[X_i]^2$ is monochromatic of color i for f_J .

PROOF. First, we do the construction for $i = 0$. The set X_0 is defined as $\{0^{n_i}1 : i \in \omega\}$ for an increasing sequence $(n_i)_{i \in \omega}$ verifying that $\emptyset'[n_i + 1] \upharpoonright n_i \neq \emptyset'[n_{i+1} + 1] \upharpoonright n_i$. Suppose that n_i is defined. Then n_{i+1} is the first integer $n > n_i$ found such that $\emptyset'[n + 1] \upharpoonright n \neq \emptyset' \upharpoonright n$ and $\emptyset'[n_i + 1] \upharpoonright n_i \neq \emptyset'[n + 1] \upharpoonright n_i$, which must exist as otherwise \emptyset' would be computable. Then, $[X_0]^2$ is monochromatic of color 0 by construction.

For the other case, define $X_1 = \{\emptyset'[n] \upharpoonright n : n \in \omega\}$, we claim that $[X_1]^2$ is monochromatic for f_J of color 1. Let $\sigma_0, \sigma_1 \in X_1$ and for $i < 2$, the length $n_i = |\sigma_i|$ is such that $\sigma_i = \emptyset'[n_i] \upharpoonright n_i$. We have $f_J(\sigma_0, \sigma_1)$ iff

$\emptyset'[\sigma_0] \upharpoonright |\sigma_0 \wedge \sigma_1| = \emptyset'[\sigma_1] \upharpoonright |\sigma_0 \wedge \sigma_1|$, which we claim is true. Indeed, as $|\sigma_0| > |\sigma_0 \wedge \sigma_1|$, we have

$$\begin{aligned} \emptyset'[\sigma_0] \upharpoonright |\sigma_0 \wedge \sigma_1| &= (\emptyset'[n_0] \upharpoonright n_0) \upharpoonright |\sigma_0 \wedge \sigma_1| \\ &= \sigma_0 \upharpoonright |\sigma_0 \wedge \sigma_1| \end{aligned}$$

and as $|\sigma_1| > |\sigma_0 \wedge \sigma_1|$:

$$\begin{aligned} \emptyset'[\sigma_1] \upharpoonright |\sigma_0 \wedge \sigma_1| &= (\emptyset'[n_1] \upharpoonright n_1) \upharpoonright |\sigma_0 \wedge \sigma_1| \\ &= \sigma_1 \upharpoonright |\sigma_0 \wedge \sigma_1|. \end{aligned}$$

By definition of the meet operator, $\sigma_0 \upharpoonright |\sigma_0 \wedge \sigma_1| = \sigma_1 \upharpoonright |\sigma_0 \wedge \sigma_1|$, therefore $f_J(\sigma_0, \sigma_1) = 1$ and $[X_1]^2$ is monochromatic of color 1. \square

THEOREM 5.50. *The statement ER^2 admits cone avoidance.*

PROOF. Let Z , and C with $C \not\leq_T Z$. Let $f : [2^{<\omega}]^2 \rightarrow 2$ be a Z -computable coloring, seen as an instance of ER^2 as $(\mathbb{Q}, <)$ and $(2^{<\omega}, <_{\mathbb{Q}})$ are computably isomorphic. Define $i_\infty = 0$ and $i_{\mathbb{Q}} = 1$, so that the goal is to find either an infinite set homogeneous for color i_∞ , or a set of order-type \mathbb{Q} homogeneous for color $i_{\mathbb{Q}}$.

The proof goes as follows: first, we build a set G such that $C \not\leq_T Z \oplus G$ but $C \leq_T (Z \oplus G)'$. Then, we apply cone avoidance of $DT_{<\infty,4}^2$ to the product of three colorings: the initial instance of ER^2 , the Jockush coloring relativized to $Z \oplus G$, and the coloring witnessing the fact that at least two colors must remain. Finally, we reason depending on which are the four remaining colors, with the two main constructions being linked with the two constructions of lemma 5.49. Let us start with the existence of G .

CLAIM 5.51. *There exists G such that $C \not\leq_T Z \oplus G$ but $C \leq_T (Z \oplus G)'$.*

PROOF. Define a forcing, whose conditions are the tuples (p, n) where $p : \omega \times \omega \rightarrow 2$ has finite domain, and n is an integer. A condition (q, m) extends a condition (p, n) if $q \supset p$, and for every $(x, y) \in \text{dom}(q) \setminus \text{dom}(p)$, if $x < n$ then $q(x, y) = C(x)$. It is clear that if G is generic enough for this forcing, then $G' \geq_T C$: Indeed, for every i , the set of conditions $\{(p, n) : n \geq i\}$ is dense. Therefore, $\lim_{s \rightarrow \infty} G(i, s)$ is always defined with value $C(i)$.

It remains to show that $C \not\leq_T Z \oplus G$. We prove that for every e , the set of conditions (p, n) for which there is an i such that $\Phi_e^{Z \oplus p}(i) \downarrow \neq C(i)$ or there is an i such that for all (q, m) extending (p, n) , $\Phi_e^{Z \oplus q}(i) \uparrow$, is dense. Indeed, fix (p_0, n_0) . If there exists $(p, n) \leq (p_0, n_0)$ and i such that $\Phi_e^{Z \oplus p}(i) \downarrow \neq C(i)$, then (p, n_0) extends (p_0, n_0) and forces $\Phi_e^{Z \oplus G}$ not to compute C . If there is an i such that no $(q, n) \leq (p_0, n_0)$ are such that $\Phi_e^{Z \oplus q}(i) \downarrow$, then already (p_0, n_0) forces partiality of $\Phi_e^{Z \oplus G}$. If none of the two previous cases happen, then Z computes C : to know the value of $C(i)$, guess the first n_0 values of C , using these find a $(q, n) \leq (p_0, n_0)$ such that $\Phi_e^{Z \oplus q}(i) \downarrow$, we have $\Phi_e^{Z \oplus q}(i) = C(i)$. This contradicts that $C \not\leq_T Z$. \square

Let f_J^G be the coloring defined in the proof of Theorem 5.28 relativized to $Z \oplus G$, that is, $f_J^G(\sigma, \tau) = 1$ iff $(Z \oplus G)'[\sigma] \upharpoonright |\sigma \wedge \tau| = (Z \oplus G)'[\tau] \upharpoonright |\sigma \wedge \tau|$. If $|\tau| > |\sigma|$, we can see color 1 for f_J^G as saying: $|\tau|$ witness that the interval from $|\sigma \wedge \tau|$ to $|\sigma|$ is “large” (relatively to $Z \oplus G$). To reflect this, we define $i_s = 0$ the “small” color, and $i_\ell = 1$ the “large” color. As in Theorem 5.28, let also $f_{<\mathbb{Q}}(\sigma, \tau) = 1$ iff $(\sigma <_{\mathbb{Q}} \tau \iff |\sigma| < |\tau|)$, note that $f_{<\mathbb{Q}}$ can be seen as the coloring which outputs the finite Joyce structure of $\{\sigma, \tau\}$. For the colors of $f_{<\mathbb{Q}}$, we will use the variable $i_{<\mathbb{Q}}$.

Finally, define $g : [2^{<\omega}]^2 \rightarrow (2 \times 2 \times 2)$ by

$$g(\sigma, \tau) = (f(\sigma, \tau), f_J^G(\sigma, \tau), f_{<\mathbb{Q}}(\sigma, \tau)).$$

We apply cone avoidance of $\text{DT}_{<\infty, 4}^2$, Corollary 5.45, to the coloring g to get a set $S \subseteq 2^{<\omega}$ such that $S \oplus G \oplus Z \not\geq_T C$ and $(S, <_{\mathbb{Q}})$ is a dense linear order with no endpoints, and such that g takes at most 4 colors on $[S]^2$.

Recall that none of the colors of $f_{<\mathbb{Q}}$ can be avoided in a subset of $2^{<\omega}$ of order-type \mathbb{Q} , therefore the two sets $S_{i_{<\mathbb{Q}}} = \{(\sigma, \tau) : f_{<\mathbb{Q}}(\sigma, \tau) = i_{<\mathbb{Q}}\}$ for $i_{<\mathbb{Q}} < 2$ must be non empty; and the sum of the number of colors taken by g on them is at most 4. Start by supposing that for each $i_{<\mathbb{Q}} < 2$, g takes at most 2 colors on $S_{i_{<\mathbb{Q}}}$.

We reason depending on the following cases:

Case 1: *There exists $i_{<\mathbb{Q}} < 2$, such that $S_{i_{<\mathbb{Q}}}$ is monochromatic for f_J^G .*

Case 2: *There exists $i_{<\mathbb{Q}} < 2$, such that on $S_{i_{<\mathbb{Q}}}$, $f = f_J^G$.*

Case 3: *There exists $i_{<\mathbb{Q}} < 2$, such that on $S_{i_{<\mathbb{Q}}}$, either f is homogeneous of color i_∞ , or $f = 1 - f_J^G$.*

Case 4: *For all $i_{<\mathbb{Q}} < 2$, $S_{i_{<\mathbb{Q}}}$ is monochromatic of color $i_{\mathbb{Q}}$ for f .*

We now prove the four cases in three different construction, Case 4 being trivial. The first construction is the one from Theorem 5.28, and shows that Case 1 cannot happen. The second and third construction correspond to the two constructions of Lemma 5.49. To separate them more clearly, the proof is divided in claims.

CLAIM 5.52. *In Case 1, $S \oplus Z \oplus G$ computes $(Z \oplus G)'$.*

PROOF. The first paragraph after the proof of Fact 5.30 asserts that the function f_J^G must be monochromatic for color i_ℓ . The second paragraph asserts that in this case, $S \oplus G \oplus Z$ computes $(Z \oplus G)'$. \square

By our choice of G , $(Z \oplus G)'$ computes C , and thus $S \oplus Z \oplus G \geq_T C$, a contradiction with our choice of S , so Case 1 cannot happen.

CLAIM 5.53. *In Case 2, there exists a set $\hat{S} \subseteq S$ computable in $S \oplus Z \oplus G$, such that $[\hat{S}]^2 \subseteq S_{i_{<\mathbb{Q}}}$ is an infinite subset monochromatic for color i_∞ .*

PROOF. Note that by the fact that we are in Case 2, a set \hat{S} with $[\hat{S}]^2 \subseteq S_0$ is such that $[\hat{S}]^2$ is monochromatic of color i_∞ for f if and only if it is monochromatic of color i_s for f_J^G . The following construction corresponds to the first case of Lemma 5.49. We computably in $S \oplus G \oplus Z$ define a sequence (F_n, A_n) , where F_n is a finite approximation to \hat{S} and A_n a reservoir for future addition to F_n , such that for all $n \in \omega$ the following holds:

- (1) F_n is a finite set such that $[F_n]^2 \subseteq S_{i_{<\mathbb{Q}}}$;
- (2) $A_n \subseteq S$ is of order-type \mathbb{Q} ;
- (3) $F_n \subsetneq F_{n+1}$ and $A_{n+1} \subseteq A_n$;
- (4) for all $\sigma \in F_n$ and all $\tau \in F_n \cup A_n$, $(\sigma, \tau) \in S_{i_{<\mathbb{Q}}}$ and $f_J^G(\sigma, \tau) = i_s$;
- (5) for all $\sigma \in F_{n+1} \setminus F_n$, $\sigma \in A_n$.

Suppose F_n, A_n are defined. If there is no $\sigma, \tau_0, \tau_1 \in A_n$ with $(\sigma, \tau_i) \in S_{i_{<\mathbb{Q}}}$ for $i < 2$ such that $(G \oplus Z)' \upharpoonright [\sigma] \upharpoonright \ell \neq (G \oplus Z)' \upharpoonright \ell$ where $\ell = \min |\sigma \wedge \tau_0|, |\sigma \wedge \tau_1|$, then $A_n \oplus G \oplus Z$ would compute $(G \oplus Z)' \geq_T C$. Define $F_{n+1} = F_n \cup \{\sigma\}$ and

$$A_{n+1} = \{\tau \in A_n : (G \oplus Z)' \upharpoonright \ell = (G \oplus Z)' \upharpoonright [\tau] \upharpoonright \ell \wedge \tau_0 <_{\mathbb{Q}} \tau <_{\mathbb{Q}} \tau_1\}.$$

By construction, all items are satisfied. Define $\hat{S} = \bigcup_n F_n$. By Item 3, \hat{S} is infinite, and by Item 4 and 5, $[\hat{S}]^2$ is monochromatic of color i_s for f_J^G , and thus monochromatic of color i_∞ for f . \square

CLAIM 5.54. *In Case 3, there exists $\hat{S} \subseteq S$ such that $\hat{S} \oplus Z \not\geq_T C$ and $[\hat{S}]^2 \subseteq S_i$ is an infinite set monochromatic of color i_∞ for f .*

PROOF. If f is homogeneous of color i_∞ on $S_{i_{<\mathbb{Q}}}$ then $S_{i_{<\mathbb{Q}}}$ is already a witness of the claim. Otherwise, $f(\sigma, \tau) = i_\infty$ if and only if $f_J^X(\sigma, \tau) = i_\ell$, so all we need is to find a subset $\hat{S} \subseteq S$ such that $[\hat{S}]^2 \subseteq S_{i_{<\mathbb{Q}}}$ and $[\hat{S}]^2$ is monochromatic of color i_ℓ for f_J^G .

The following construction is roughly analogous to the second case in the proof of Lemma 5.49, however the number of time we can take a lower meet to avoid having color i_s is not anymore equal to the number of times we might have to do it. This prevents us from doing the construction computably, however we can still make it cone avoiding. We build \hat{S} using the following forcing:

DEFINITION 5.55. A *condition* is a couple (F, D) such that F is a finite set with $[F]^2 \subseteq S_{i_{<\mathbb{Q}}}$, and $D \subseteq S$ is computable in S and of order-type \mathbb{Q} , and such that: for all $\sigma \in F$ and all $\tau \in F \cup D$, $(\sigma, \tau) \in S_{i_{<\mathbb{Q}}}$ and $f_J^G(\sigma, \tau) = i_\ell$.

A condition (F_1, D_1) *extends* a condition (F_0, D_0) if $D_1 \subseteq D_0$ and for all $\sigma \in F_1 \setminus F_0$, $\sigma \in D_0$. We write $(F_1, D_1) \leq (F_0, D_0)$.

If \mathcal{F} is a filter for this forcing, then we let $S_{\mathcal{F}} = \bigcup \{F : (\exists D)[(F, D) \in \mathcal{F}]\}$. We have that $[S_{\mathcal{F}}]^2 \subseteq S_{i_{<\mathbb{Q}}}$ is monochromatic of color i_ℓ for f_J^G . So

we need to find a filter ensuring that $S_{\mathcal{F}}$ is infinite and $S_{\mathcal{F}} \oplus Z$ does not compute C .

DEFINITION 5.56. Let (F, D) be a condition and φ be a $\Delta_0^{0,Z}$ formula with a free set parameter \hat{S} . We say that:

- (1) $(F, D) \Vdash (\exists x)\varphi(\hat{S}, x)$ if $\varphi(F, x)$ holds for some $x \in \omega$;
- (2) $(F, D) \Vdash (\forall x)\varphi(\hat{S}, x)$ if $\varphi(F \cup E, x)$ holds for every x , and for every $E \subseteq D$ with $[F \cup E]^2 \subseteq S_{i_{<Q}}$ monochromatic of color i_ℓ for f_J^G .

We claim that for every Turing functional, for every condition (F, D) , there is a condition $(F', D') \leq (F, D)$ such that $(F', D') \Vdash \Gamma^{\hat{S} \oplus Z} \neq C$. Let $D_0 <_{\mathbb{Q}} D_1$ be two subsets of D computable in S of order type \mathbb{Q} : For instance, pick $x_0 <_{\mathbb{Q}} x_1 <_{\mathbb{Q}} x_2$ in D , and define $D_0 = \{x \in D : x_0 <_{\mathbb{Q}} x <_{\mathbb{Q}} x_1\}$ and $D_1 = \{x \in D : x_1 <_{\mathbb{Q}} x <_{\mathbb{Q}} x_2\}$. Fix $e \in \omega$.

Define the following c.e. set, where by “ E is compatible with F ” we mean that for all $\sigma, \tau \in F \cup E$, $f_J^G(\sigma, \tau) = i_\ell$ and $[F \cup E]^2 \subseteq S_{i_{<Q}}$:

$$W = \{(x, i) : (\exists E \subseteq_{\text{fin}} D_{1-i_{<Q}}) \text{ compatible with } F\} [\Phi_e^{F \cup E \oplus G \oplus Z}(x) \downarrow = i].$$

We consider the three following cases.

Case 1: *There exists $x \in \omega$ such that $(x, 1 - C(x)) \in W$.* Let E be a witness of this. The condition $(F \cup E, \hat{D}_{i_{<Q}})$ forces Φ_e to be different from C , where $\hat{D}_{i_{<Q}}$ is $D_{i_{<Q}}$ with a finite number of elements removed, so that for all $\sigma \in E$ and all $\tau \in \hat{D}_{i_{<Q}}$, $(G \oplus Z)' \upharpoonright |\sigma| = (G \oplus Z)' \upharpoonright |\tau| \upharpoonright |\sigma|$.

Case 2: *There exists $x \in \omega$ such that for each $i \in 2$, $(x, i) \notin W$.* The condition $(F, D_{1-i_{<Q}})$ already forces divergence of Φ_e .

Case 3: *Otherwise.* Thus, for every x there is an i such that $(x, i) \in W$ and $(x, i) \in W \implies i = C(x)$. But as W is c.e, this implies that C is computable, a contradiction.

Finally, any sufficiently generic for this forcing is infinite: indeed, consider the functional Γ which halts if and only if its oracle has at least n elements. It is impossible to have a condition forcing Γ to halt, so any sufficiently generic has at least n elements, and so for every n . \square

By the previous claims, Case 1 cannot happen, and Cases 2 and 3 validate the theorem with an infinite and cone avoiding set homogeneous for color i_∞ . In Case 4, we are also done, as S is a homogeneous set for color $i_{\mathbb{Q}}$, of order-type $i_{\mathbb{Q}}$.

In the making of the four cases, we supposed that each $S_{i_{w_{\mathbb{Q}}}}$ takes at most two colors. It remains the case when for some $i_{<Q}$, $S_{i_{<Q}}$ takes only one color by g , and $S_{1-i_{<Q}}$ takes three colors by g . But then, Case 1 holds for $i_{<Q}$, a contradiction. \square

CHAPTER 6

The Rado graph theorem

6.1. A big Ramsey structure for the Rado graph

DEFINITION 6.1. A *Joyce graph* is a graph $\mathcal{G} = (G, E)$ together with an order $<$ on G and a symmetric function $\llbracket \cdot, \cdot \rrbracket : G^2 \rightarrow \mathbb{N}$ such that $(G, <, \llbracket \cdot, \cdot \rrbracket)$ is a Joyce order and

$$(J4) \text{ for all } x, y, z \in G, \llbracket x, x \rrbracket < \llbracket y, z \rrbracket \implies (xEy \iff xEz).$$

As in the previous chapter, the function $\llbracket \cdot, \cdot \rrbracket$ has to be taken as the height of a meet. The axiom (J4) states that if two elements have a meet above the height of a third element, they are both linked to it or none are linked to it. In this sense, the axiom states some compatibility between the $\llbracket \cdot, \cdot \rrbracket$ operator and the edge relation. However, compared to the axiom (J2) which states a compatibility between the order and the $\llbracket \cdot, \cdot \rrbracket$ operator, the crucial height is the one of the element and not of the meet. In other words, the relevant height to decide whether $x < y$ is at the level of the meet, while the relevant height to decide the edge relation between x and y is at the level of x or y .

DEFINITION 6.2. A *Joyce Rado graph* is a Joyce graph $(G, E, <, \llbracket \cdot, \cdot \rrbracket)$ such that (G, E) is a Rado graph.

In what follows, define the relation E_{pn} on strings of different length by $\sigma E_{\text{pn}} \tau$ if and only if $\sigma(|\tau|) = 1$ and $|\tau| < |\sigma|$, or $\tau(|\sigma|) = 1$ and $|\sigma| < |\tau|$.

THEOREM 6.3 (RCA₀). *There exists a Joyce Rado graph.*

PROOF. Consider $g : 2^{<\omega} \rightarrow 2^{<\omega}$ to be the function such that $g(\sigma) = \tau$, where $|\tau| = 3|\sigma| + 2$, for all $n < |\sigma|$, $\tau(3n) = \tau(3n + 1) = \tau(3n + 2) = \sigma(n)$, and $\tau(3|\sigma|) = 0$, $\tau(3|\sigma| + 1) = 1$. The image of g is a antichain. Fix an injective function $v : 2^{<\omega} \rightarrow \omega$ such that for every $\sigma, \tau \in 2^{<\omega}$, if $|\sigma| < |\tau|$ then $v(\sigma) < v(\tau)$, and for every $\sigma, \tau \in 2^{<\omega}$, define $\llbracket \sigma, \tau \rrbracket = v(\sigma \wedge \tau)$. Last, fix a cofinal set $S \subseteq 2^{<\omega}$ such that for all $\sigma, \tau \in S$, $|\sigma| \neq |\tau|$. The claim is that $(g[S], E_{\text{pn}}, <_{\text{lex}}, \llbracket \cdot, \cdot \rrbracket)$ is a Joyce Rado graph.

We prove that $(g[S], E_{\text{pn}}, <_{\text{lex}}, \llbracket \cdot, \cdot \rrbracket)$ satisfies axioms (J1), (J2), (J3) and (J4). Let $x, y, z, t \in g[S]$, not all equal, with $x \leq_{\text{lex}} y$ and $z \leq_{\text{lex}} t$.

(J1): Suppose $\llbracket x, y \rrbracket < \llbracket x, z \rrbracket$. By definition, $v(x \wedge y) < v(x \wedge z)$. By choice of the map v , $|x \wedge y| \leq |x \wedge z|$, so $x <_{\text{lex}} y$ iff $z <_{\text{lex}} y$.

(J2): Suppose $\llbracket x, y \rrbracket < \llbracket x, z \rrbracket$. By definition, $v(x \wedge y) < v(x \wedge z)$. By choice of the map v , $|x \wedge y| \leq |x \wedge z|$, so $x \wedge y = z \wedge y$, hence $v(x \wedge y) = v(z \wedge y)$.

(J3): Suppose $\llbracket x, y \rrbracket = \llbracket z, t \rrbracket$. By definition, $v(x \wedge y) = v(z \wedge t)$. By injectivity of the map v , $x \wedge y = z \wedge t$, so $x \wedge y \prec x \wedge z$ and $x \wedge y \prec y \wedge t$, hence $v(x \wedge y) <_{\mathbb{N}} \min(v(x \wedge z), v(y \wedge t))$.

(J4): Let $x, y, z \in g[S]$. Suppose $\llbracket x, x \rrbracket < \llbracket y, z \rrbracket$. By definition, $v(x) = v(x \wedge x) < v(y \wedge z)$. By choice of the map v , $|x| \leq |y \wedge z|$, but as the length of elements of $g[S]$ and the length of proper meets of $g[S]$ are different by construction, $|x| < |y \wedge z|$. Therefore $y(|x|) = z(|x|)$ so $x E_{\text{pn}} y$ iff $z E_{\text{pn}} y$.

It remains to show that $(g[S], E_{\text{pn}})$ is a Rado graph. Let $F_0, F_1 \subseteq g[S]$ be finite disjoint sets. As S contains at most one element of each length, and is cofinal, let σ be a string in S such that $\sigma(\ell) = i$ whenever there exists $\tau \in S$ of size ℓ with $g(\tau) \in F_i$. By definition of g , $\sigma E_{\text{pn}} \tau$ iff $g(\sigma) E_{\text{pn}} g(\tau)$, so $g(\sigma)$ is linked with all of F_1 and none of F_0 . Therefore, $(g[S], E_{\text{pn}})$ is a Rado graph. \square

COROLLARY 6.4 (RCA₀). *Every Rado graph $\mathcal{G} = (G, E)$ can be ordered and equipped with a function $\llbracket \cdot, \cdot \rrbracket : G^2 \rightarrow \mathbb{N}$ to form a Joyce Rado graph.*

PROOF. Let $(X, E_{\text{pn}}, <_{\text{lex}}, \llbracket \cdot, \cdot \rrbracket_X)$ be the Joyce Rado graph of Theorem 6.3. By computable categoricity of the Rado graph, there exists a graph isomorphism f between $\mathcal{G} = (G, E)$ and (X, E_{pn}) . Define $x < y$ for $x, y \in G$ if and only if $f(x) <_{\text{lex}} f(y)$. Also define $\llbracket \cdot, \cdot \rrbracket : G^2 \rightarrow \mathbb{N}$ by $\llbracket x, y \rrbracket = \llbracket f(x), f(y) \rrbracket_X$. Then $(G, E, <, \llbracket \cdot, \cdot \rrbracket)$ is a Joyce Rado graph. \square

The first-order structure that is of interest for us is the following.

DEFINITION 6.5. The *Joyce (Rado) graph structure* of a Joyce (Rado) graph $(G, E, <, \llbracket \cdot, \cdot \rrbracket)$ is the structure $(G, E, <, \mathbb{R})$ such that $(G, <, \mathbb{R})$ is the Joyce structure of the Joyce order $(G, <, \llbracket \cdot, \cdot \rrbracket)$.

We shall prove later that Joyce Rado graphs structures have big Ramsey degree 1 for every finite Joyce graph structure.

STATEMENT 6.6. For all $n, k, \ell \geq 1$, $\text{JRG}_{k, \ell}^n$ is the assertion that for every Joyce Rado graph structure \mathcal{G} and every coloring $f : [\mathcal{G}]^n \rightarrow k$, there exists an isomorphic substructure \mathcal{G}' of \mathcal{G} satisfying $|f[\mathcal{G}'^n]| \leq \ell$.

As every Joyce graph is in particular a Joyce order, every finite Joyce graph of size n can be fully specified by a finite Joyce order and a finite graph, both of size n , or equivalently by a finite Joyce tree with n leaves and a finite graph of size n . In particular, for a fixed graph G of size n , there are at most as many Joyce graphs isomorphic to it as there are Joyce trees with n leaves. On the other hand, as we shall see in Figure 6.1, if a finite graph G of size n is neither the clique, nor the anti-clique with n vertices, there are some Joyce orders of size n which cannot be enriched to form a Joyce graph isomorphic to G .

THEOREM 6.7 (Joyce Rado graph theorem). *For all $n, k \geq 1$, JRG_{k, J_n}^n holds, where J_n is the number of non isomorphic Joyce graphs with n elements. Moreover, this bound is tight: $\text{JRG}_{k, \ell}^n$ does not hold for any $\ell < J_n$.*

Just as we did for the Joyce order, we can canonically represent any countable Joyce graph as a set of strings equipped with the lexicographic order and $|\cdot \wedge \cdot|$, but also the relation E_{pn} .

DEFINITION 6.8. A *coded Joyce graph* is a Joyce graph of the form

$$(X, E_{\text{pn}}, <_{\text{lex}}, |\cdot \wedge \cdot|)$$

such that for all $\sigma, \tau, \rho \in X$ with $\sigma \neq \tau$, $|\rho| > |\sigma \wedge \tau|$ and $\sigma \wedge \tau \not\leq \rho$, we have $\rho(|\sigma \wedge \tau|) = 0$.

Note that if $(X, E_{\text{pn}}, <_{\text{lex}}, |\cdot \wedge \cdot|)$ is a coded Joyce graph, that does not mean that $(X, <_{\text{lex}}, |\cdot \wedge \cdot|)$ is a coded Joyce order. Indeed, there is no restriction on $\rho(|\sigma \wedge \sigma|)$ in the case of a coded Joyce graph, while this value must be 0 in the case of a coded Joyce order. The two notions thus coincides if and only if $\neg \sigma E_{\text{pn}} \tau$ for every $\sigma, \tau \in X$, by definition of E_{pn} .

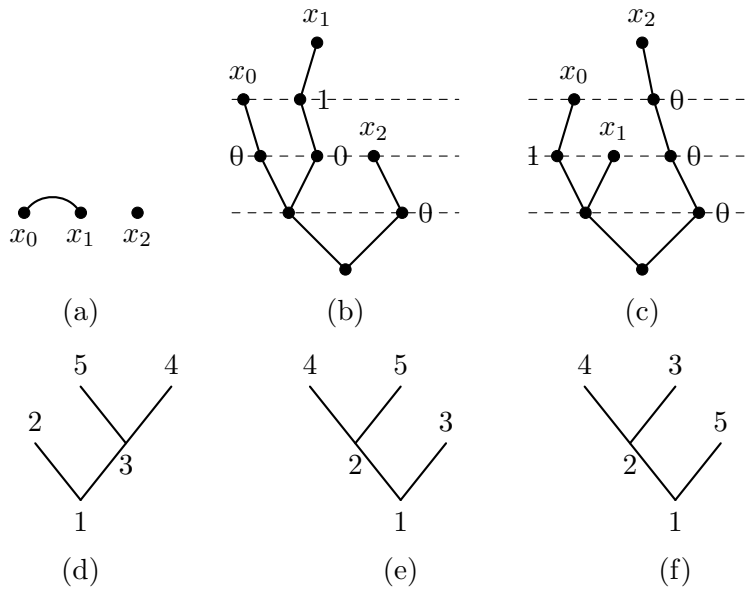

FIGURE 6.1. In (a), a finite graph $G = (\{x_0, x_1, x_2\}, \{\{x_0, x_1\}\})$. In (b) and (c), two coded Joyce graphs isomorphic to G . The trees (e) and (f) are Joyce trees corresponding the coded Joyce graphs (b) and (c), respectively. In (d), a Joyce tree which cannot represent the graph G . Indeed, since there is an edge between x_0 and x_1 but not between x_0 and x_2 , then for any coded Joyce graph $\{\sigma_0, \sigma_1, \sigma_2\}$ representing G , $|\sigma_1 \wedge \sigma_2| < |\sigma_0|$.

THEOREM 6.9 (RCA_0). *Every countable Joyce graph is isomorphic to a coded Joyce graph.*

PROOF. Let $(G, E, <, \llbracket \cdot, \cdot \rrbracket)$ be a countable Joyce graph. Let $\sigma_x \in 2^{<\omega}$ be the unique string of length $\llbracket x, x \rrbracket$, such that for any $j < \llbracket x, x \rrbracket$:

- (1) if $j = \llbracket x, y \rrbracket$ for some $y \in G$, then $\sigma_x(j) = 1$ if and only if $y < x$;
- (2) if $j = \llbracket y, y \rrbracket$ for some $y \in G$, then $\sigma_x(j) = 1$ if and only if xEy ;
- (3) $\sigma_x(j) = 0$ otherwise.

One first need to show that σ_x is well-defined. First, there is no $y, z \in G$ such that $\llbracket y, z \rrbracket = \llbracket z, z \rrbracket$ by (J3), so Item 1 and Item 2 are compatible. Item 1 do not contradict itself as there is no $y, z \in G$ such that $\llbracket y, y \rrbracket = \llbracket z, z \rrbracket$, also by (J3). It remains to show that Item 2 does not contradict itself: Let $x, y, z \in G$ be such that $\llbracket x, y \rrbracket = \llbracket x, z \rrbracket < \llbracket x, x \rrbracket$. Then, by (J3) $\llbracket x, y \rrbracket <_{\mathbb{N}} \llbracket y, z \rrbracket$ and by (J1) we have $x < z$ iff $x < z$. So σ_x is well-defined.

Let $X = \{\sigma_x : x \in G\}$. We claim that $(X, E_{\text{pn}}, <_{\text{lex}}, |\cdot \wedge \cdot|)$ is a Joyce graph whose structure is isomorphic to the Joyce structure of $(G, E, <, \llbracket \cdot, \cdot \rrbracket)$.

Let $\sigma_x, \sigma_y \in X$. We have $|\sigma_x| = \llbracket x, x \rrbracket \neq \llbracket y, y \rrbracket = |\sigma_y|$, we suppose $|\sigma_x| < |\sigma_y|$. But then, $\sigma_x E_{\text{pn}} \sigma_y$ iff $\sigma_y(|\sigma_x|) = 1$ iff xEy by Item 2.

The rest of the proof follows the same argument that the construction in the proof of Theorem 5.11 works. We prove that for all $x, y, z, t \in G$, $\llbracket x, y \rrbracket < \llbracket z, t \rrbracket \implies |\sigma_x \wedge \sigma_y| <_{\mathbb{N}} |\sigma_z \wedge \sigma_t|$. We actually prove the stronger fact that for every $x, y \in G$, $\llbracket x, y \rrbracket = |\sigma_x \wedge \sigma_y|$. If $x = y$, it is clear as by construction, σ_x is of length $\llbracket x, x \rrbracket$. If $x \neq y$, we first prove that $\llbracket x, y \rrbracket \leq |\sigma_x \wedge \sigma_y|$: indeed, for all $n < \llbracket x, y \rrbracket$, by (J1), (J4) and the construction, we have $\sigma_x(n) = 1$ iff $\sigma_y(n) = 1$. It remains to show $\llbracket x, y \rrbracket \geq |\sigma_x \wedge \sigma_y|$: if $x < y$ we have that $\sigma_x(\llbracket x, y \rrbracket) = 0 \neq 1 = \sigma_y(\llbracket x, y \rrbracket)$ by Item 1, so $\llbracket x, y \rrbracket \geq |\sigma_x \wedge \sigma_y|$, and similarly for $x > y$.

Let $x < y \in G$. Then, $\llbracket x, y \rrbracket = |\sigma_x \wedge \sigma_y|$, thus $\sigma_x(|\sigma_x \wedge \sigma_y|) = 0 \neq 1 = \sigma_y(|\sigma_x \wedge \sigma_y|)$ by Item 2. It follows that $\sigma_x <_{\text{lex}} \sigma_y$. □

COROLLARY 6.10. *There exists a computably coded Joyce Rado graph.*

PROOF. Immediate by Theorem 6.9 and Theorem 6.3. □

6.2. Joyce blossom graphs and an embedding theorem

DEFINITION 6.11. A *blossom tree* is a pair (f, g) where $f : 2^{<\omega} \rightarrow 2^{<\omega}$ is a \prec -preserving, $<_{\text{lex}}$ -preserving and \wedge -preserving function, such that for every $\sigma, \tau \in 2^{<\omega}$:

- (1) $g(\sigma) \succ f(\sigma)$;
- (2) if $|\tau| > |\sigma|$ then $|f(\tau)| > |g(\sigma)|$;
- (3) if $|\tau| = |\sigma|$ then $f(\tau 0)(|g(\sigma)|) \neq f(\tau 1)(|g(\sigma)|)$.

A *Joyce blossom graph* is a structure $(g[S], E_{\text{pn}}, <_{\text{lex}}, |\cdot \wedge \cdot|)$ for some blossom tree (f, g) and some set S cofinal in $2^{<\omega}$ such that for all $\sigma, \tau \in S^\wedge$, $|\sigma| \neq |\tau|$.

Note that a Joyce blossom graph \mathcal{G} is a Joyce Rado graph: indeed, let F_0 and F_1 be two disjoint finite sets of vertices of \mathcal{G} , and let f, g and S be the witnesses of the fact that \mathcal{G} is a Joyce blossom graph. By Item 3 of the

definition, there exists $\sigma \in f[2^{<\omega}]$ with $|\sigma| > \max\{|\tau| : \tau \in F_0 \cup F_1\}$ and such that for every $\tau \in F_0 \cup F_1$ $\sigma(|\tau|) = 0$ iff $\tau \in F_0$. By the fact that S is cofinal, let $\rho \succ f^{-1}(\sigma)$ in S . Then, $g(\rho) \succ \sigma$, and therefore $g(\rho)E_{\text{pn}}\tau$ if $\tau \in F_1$ and $\neg g(\rho)E_{\text{pn}}\tau$ if $\tau \in F_0$. The Joyce requirements are satisfied by the fact that the relations are E_{pn} , $<_{\text{lex}}$ and $|\cdot \wedge \cdot|$, and that for all $\sigma, \tau \in S^\wedge$, $|\sigma| \neq |\tau|$.

Note that if (f, g) is a blossom tree, then letting $B = g[2^{<\omega}]$ it follows by Item 1 that (B, \preceq) is an antichain and $(B, <_{\text{lex}})$ contains a dense linear order with no endpoints. From a computability-theoretic viewpoint, \prec -preservation of f and Item 1 of Definition 6.11 ensures that if (f, g) is computable, then so is $g[2^{<\omega}]$. Conversely, Item 2 of Definition 6.11 implies that (f, g) is computable from $g[2^{<\omega}]$. One can therefore switch from one notion to the other in the computability realm.

LEMMA 6.12. *There exists a computable Joyce blossom graph, with a DLO induced order.*

PROOF. Let g and S be the objects defined in the proof of Theorem 6.3, and $\mathcal{G} = (g[S], E_{\text{pn}}, <_{\text{lex}}, \llbracket \cdot, \cdot \rrbracket)$ be the Joyce graph defined in the same proof. By Theorem 6.9, let $\mathcal{G}' = (G', E_{\text{pn}}, <_{\text{lex}}, |\cdot \wedge \cdot|)$ be the coded Joyce Rado Graph computably isomorphic to \mathcal{G} via e .

It remains to show that \mathcal{G}' is a Joyce blossom graph. Define $g' = e \circ g$ and $f : \sigma \mapsto g'(\tau_0) \wedge g'(\tau_1)$. It is easy to check that f, g' and the set S are witnesses of the fact that \mathcal{G}' is a Joyce blossom graph. \square

LEMMA 6.13 (RCA₀). *For every Rado graph (G, E) , there exists a graph embedding $e : (2^{<\omega}, E_{\text{pn}}) \rightarrow (G, E)$.*

PROOF. Let $(\sigma_n)_{n \in \omega}$ be an enumeration of $2^{<\omega}$ such that $|\sigma_n| > |\sigma_m|$ implies $n > m$. Suppose $e(\sigma_i)$ is defined for every $i < n$. Let $F_0 = \{e(\tau) : \tau \in 2^{<\omega}, |\tau| < |\sigma_n|, \sigma_n(|\tau|) = 0\}$ and $F_1 = \{e(\tau) : \tau \in 2^{<\omega}, |\tau| < |\sigma_n|, \sigma_n(|\tau|) = 1\}$. By the fact that (G, E) is a Rado graph, there exists an $g \in G$ such that for all $a \in F_0$, $\neg aEg$ and for all $a \in F_1$, aEg , and g is not already in the image of e . Define $e(\sigma_n) = g$. \square

THEOREM 6.14 (ACA₀). *For every coded Joyce Rado graph $\mathcal{G} = (G, E, <, \llbracket \cdot, \cdot \rrbracket)$, there is an embedding from a Joyce blossom graph to G .*

PROOF. We show the stronger result that there exists a blossom tree (f, g) such that $(g[2^{<\omega}], E_{\text{pn}}, <_{\text{lex}}, |\cdot \wedge \cdot|)$ embeds into \mathcal{G} . Thus, for any $S \subseteq 2^{<\omega}$ such that for all $\sigma, \tau \in S^\wedge$ we have $|\sigma| \neq |\tau|$ whenever $\sigma \neq \tau$, we have $(g[S], E_{\text{pn}}, <_{\text{lex}}, |\cdot \wedge \cdot|)$ embeds into \mathcal{G} .

Let $e : (2^{<\omega}, E_{\text{pn}}) \rightarrow (G, E_{\text{pn}})$ be the graph embedding constructed in Lemma 6.13. We say that $L \subseteq 2^{<\omega}$ is *large above* $\tau \in 2^{<\omega}$ if $e^{-1}[L]$ is cofinal in $2^{<\omega}$ above τ . The set L is large if it is large above some $\tau \in 2^{<\omega}$. Note that the collection of large sets is partition regular, that is, if $L_0 \cup \dots \cup L_{d-1}$ is large, then there is some $j < d$ such that L_j is large. Moreover, if L is large above τ , then it is large above any $\rho \succeq \tau$. Last, G is large above ϵ .

Given a $\sigma \in 2^{<\omega}$, we write $G \upharpoonright \sigma = \{\tau \in G : \tau \succeq \sigma\}$. Note that if $G \upharpoonright \sigma$ is large above τ , then so is $G \upharpoonright \rho$ for every $\rho \preceq \sigma$.

The following claim is the combinatorial core of the theorem.

CLAIM 6.15. *If $G \upharpoonright \sigma$ is large, then for cofinitely many $\rho \in 2^{<\omega}$, there are some $\sigma_0, \sigma_1 \in G$ such that $G \upharpoonright \sigma_0$ and $G \upharpoonright \sigma_1$ are large, $\sigma \preceq \sigma_0 \wedge \sigma_1$ and $\sigma_0(\ell) \neq \sigma_1(\ell)$, where $\ell = |e(\rho)|$.*

PROOF. Say $G \upharpoonright \sigma$ is large above some τ . Pick any $\rho \in 2^{<\omega}$ such that $|\rho| \geq |\tau|$. Since if $G \upharpoonright \sigma$ is large above τ , $G \upharpoonright \sigma$ is large above any $\mu \succeq \tau$, then we can assume that $|\tau| = |\rho|$. Unfolding the definition of largeness, the set $C = e^{-1}[G \upharpoonright \sigma]$ is cofinal above τ . Since $e : (2^{<\omega}, E_{\text{pn}}) \rightarrow (G, E_{\text{pn}})$ is a graph embedding and $|\tau| = |\rho|$, then for every $\mu \succeq \tau 0$, $\neg(\mu E_{\text{pn}} \rho)$, hence $\neg(e(\mu) E_{\text{pn}} e(\rho))$ and for every $\mu \succeq \tau 1$, $\mu E_{\text{pn}} \rho$, hence $e(\mu) E_{\text{pn}} e(\rho)$. It follows that, letting $L_0 = \{\nu \in G \upharpoonright \sigma : \neg(\nu E_{\text{pn}} e(\rho))\}$ and $L_1 = \{\nu \in G \upharpoonright \sigma : \nu E_{\text{pn}} e(\rho)\}$, then $C_0 = e^{-1}[L_0] = \{\mu \succeq \tau 0 : \mu \in C\}$ and $C_1 = e^{-1}[L_1] = \{\mu \succeq \tau 1 : \mu \in C\}$. Since C is cofinal above τ , then C_0 and C_1 are cofinal above $\tau 0$ and $\tau 1$, respectively, so L_0 and L_1 are large above $\tau 0$ and $\tau 1$, respectively.

Let $\ell = |e(\rho)|$. Note that since L_0 and L_1 are both non-empty, then $\ell \geq |\sigma|$. $L_0 = \bigcup_{\nu \succeq \sigma: |\nu|=\ell} G \upharpoonright \nu 0$ and $L_1 = \bigcup_{\nu \succeq \sigma: |\nu|=\ell} G \upharpoonright \nu 1$. By partition regularity of largeness, there are some $\nu_0, \nu_1 \succeq \sigma$ such that $|\nu_0| = |\nu_1| = \ell$, and $G \upharpoonright \nu_0 0$ and $G \upharpoonright \nu_1 1$ are large. Let $\sigma_0 = \nu_0 0$ and $\sigma_1 = \nu_1 1$. This proves our claim. \square

We are now ready to prove Theorem 6.14. Using Claim 6.15, we build a \prec -preserving and \prec_{lex} -preserving function $\phi : 2^{<\omega} \rightarrow 2^{<\omega}$, together with a function $g : 2^{<\omega} \rightarrow G$ such that for every $\sigma \in 2^{<\omega}$:

- (1) $G \upharpoonright \phi(\sigma)$ is large; $g(\sigma) \succeq \phi(\sigma 0) \wedge \phi(\sigma 1)$;
- (2) for every $\rho \in 2^{|\sigma|}$, $\phi(\rho 0)(|g(\sigma)|) \neq \phi(\rho 1)(|g(\sigma)|)$.

Initially, $\phi(\epsilon) = \epsilon$ and g is nowhere defined. Assume ϕ is defined over $2^{\leq k}$ and g over $2^{<k}$ for some $k \in \omega$.

Defining ϕ . Consider successively each $\sigma \in 2^k$. By partition regularity of largeness, $G \upharpoonright \nu$ is large for some $\nu \succeq \phi(\sigma)$ such that $|\nu|$ is bigger than any value considered so far. By Claim 6.15, there is a ρ two nodes μ_0, μ_1 extending ν such that, letting $\ell = |e(\rho)|$, $G \upharpoonright \mu_0$ and $G \upharpoonright \mu_1$ are large and $\mu_0(\ell) < \mu_1(\ell)$. Temporarily define $\phi(\sigma 0) = \mu_0$ and $\phi(\sigma 1) = \mu_1$. The actual value of $\phi(\sigma 0)$ and $\phi(\sigma 1)$ might change while defining g , but will be extensions of these strings. Since $\phi(\sigma 0) \wedge \phi(\sigma 1) = \mu_0 \wedge \mu_1 \succeq \nu$, $|\phi(\sigma 0) \wedge \phi(\sigma 1)|$ is bigger than any value considered so far.

Defining g . Consider successively each $\tau \in 2^k$. We need to define $g(\tau)$ so that it satisfies Item 2. Since $G \upharpoonright \phi(\tau)$ is large, it is infinite, so by Claim 6.15, there is a single ρ such that $e(\rho) \succeq \phi(\tau)$ and $\ell = |e(\rho)|$ is bigger than any value considered so far, and for every $\sigma \in 2^k$ and $i < 2$ there are two extensions μ_0, μ_1 of $\phi(\sigma i)$ such that $\mu_0(\ell) < \mu_1(\ell)$. Then let $\phi(\sigma i) = \mu_i$ and $g(\tau) = e(\rho)$ and consider the next $\tau \in 2^k$.

Defining f . We now define f so that (f, g) is a blossom tree. For every $\sigma \in 2^{<\omega}$, let $f(\sigma) = \phi(\sigma 0) \wedge \phi(\sigma 1)$. Then $f : 2^{<\omega} \rightarrow 2^{<\omega}$ is a \prec -preserving, $<_{\text{lex}}$ -preserving and \wedge -preserving function such that for every $\sigma \in 2^{<\omega}$:

- (1) $g(\sigma) \succeq f(\sigma) \succeq \phi(\sigma)$;
- (2) for every $\rho \in 2^{|\sigma|}$, $f(\rho 0)(|g(\sigma)|) \neq f(\rho 1)(|g(\sigma)|)$.

Thus (f, g) is a blossom tree, with $g : 2^{<\omega} \rightarrow G$. Let $S \subseteq 2^{<\omega}$ be a cofinal set such that S^\wedge has at most one string of each length. The structure $(g[S], E_{\text{pn}}, <_{\text{lex}}, |\cdot \wedge \cdot|)$ is a Joyce blossom graph. \square

THEOREM 6.16 (RCA₀). *For every Joyce blossom graph \mathcal{G} and every (finite or infinite) Joyce graph \mathcal{F} , there is a Joyce structure embedding from \mathcal{F} to \mathcal{G} .*

PROOF. Let (f, g) be the blossom tree and $S \subseteq 2^{<\omega}$ such that $\mathcal{G} = (g[S], E_{\text{pn}}, <_{\text{lex}}, |\cdot \wedge \cdot|)$. Let $F \subseteq 2^{<\omega}$ be the domain of a coded Joyce graph isomorphic to \mathcal{F} . Let $D = \{d_i : i \in |F^\wedge|\}$ be an enumeration of F^\wedge such that $i < j$ implies $|d_i| < |d_j|$. We first build a function $\phi : D \rightarrow S$. Define $\phi(d_0)$ to be any element of S . Suppose $\phi(d_i)$ is defined for $i < n$. Then d_n is mapped to any element of S extending σ , where σ is the string of length $|\phi(n-1)| + 1$, such that:

- (1) if $k < |\sigma|$ and $k \neq |\phi(d_i)|$ for any $i < n$, then $\sigma(k) = 0$;
- (2) if $d_i \prec d_n$, then $\sigma(|\phi(d_i)|) = 1$ iff $d_i 1 \prec d_n$;
- (3) Otherwise $\sigma(|\phi(d_i)|) = j$ so that $f(\sigma)(|g(\phi(d_i))|) = d_n(|d_i|)$.

The last item can be satisfied for a single j by Item 3 of Definition 6.11. The string σ is uniquely defined, and $\phi(d_n) \in S$ extending σ exists as S is cofinal. Note that ϕ is \prec -preserving: if $d_n \prec d_m$, then by Item 1, for any $k < |\phi(d_n)|$ if $k \notin \{|\phi(d_i)| : i < n\}$, then $\phi(d_n)(k) = \phi(d_m)(k)$. By Item 2 for any i such that $d_i \prec d_n$, $\phi(d_n)(|\phi(d_i)|) = \phi(d_m)(|\phi(d_i)|)$. By Item 3 and the fact that f is \prec -preserving, for i such that $d_i \not\prec d_n$, we again have $\phi(d_n)(|\phi(d_i)|) = \phi(d_m)(|\phi(d_i)|)$. So ϕ is \prec -preserving.

Define $\psi = g \circ \phi$. We claim that $\psi : F \rightarrow g[S]$ preserves the Joyce graph structure. In order to show the claim, we have to prove that it preserves $<_{\text{lex}}$, and that for any $d_{n_0}, d_{n_1}, d_{m_0}, d_{m_1} \in F$, $|d_{n_0} \wedge d_{n_1}| < |d_{m_0} \wedge d_{m_1}|$ implies $|\psi(d_{n_0}) \wedge \psi(d_{n_1})| < |\psi(d_{m_0}) \wedge \psi(d_{m_1})|$, and finally that for any $d_n, d_m \in F$, $d_n E_{\text{pn}} d_m$ implies $\psi(d_n) E_{\text{pn}} \psi(d_m)$. The proof of these three facts are respectively in the three following paragraphs.

The fact that ϕ is \prec -preserving implies that $\phi(d_n \wedge d_m) \prec \phi(d_n) \wedge \phi(d_m)$. By Item 2, $\phi(d_n \wedge d_m) \succ \phi(d_n) \wedge \phi(d_m)$: indeed, $\phi(d_n)(|\phi(d_n \wedge d_m)|) \neq \phi(d_m)(|\phi(d_n \wedge d_m)|)$. So ϕ is \wedge -preserving, and by Item 2, it is also $<_{\text{lex}}$ -preserving. The function g is also $<_{\text{lex}}$ -preserving: f is $<_{\text{lex}}$ -preserving, and $f(\sigma) \prec g(\sigma)$ for every $\sigma \in 2^{<\omega}$. So $\psi = g \circ \phi$ is $<_{\text{lex}}$ -preserving.

By the second item of Definition 6.11, for all $\sigma, \tau \in 2^{<\omega}$ with $|\sigma| \neq |\tau|$, $|\sigma| < |\tau| \iff |g(\sigma)| < |g(\tau)| \iff |f(\sigma)| < |f(\tau)| \iff |g(\sigma)| < |f(\tau)| \iff |f(\sigma)| < |g(\tau)|$. So $|d_n| < |d_m| \iff |\psi(d_n)| < |\psi(d_m)|$. Now, suppose $|d_{n_0} \wedge d_{n_1}| < |d_{m_0} \wedge d_{m_1}|$ for some $d_{n_0}, d_{n_1}, d_{m_0}, d_{m_1} \in F$. Let

$d_n = d_{n_0} \wedge d_{n_1}$ and $d_m = d_{m_0} \wedge d_{m_1}$. If $d_{n_0} \neq d_{n_1}$, then $\psi(d_{n_0}) \wedge \psi(d_{n_1}) = f(\phi(d_n))$, otherwise $\psi(d_{n_0}) \wedge \psi(d_{n_1}) = g(\phi(d_n))$; and similarly for m_0, m_1, m with $d_m = d_{m_0} \wedge d_{m_1}$. So, depending whether $d_n, d_m \in F$, we use one of the previous equivalence to get that $|\psi(d_{n_0}) \wedge \psi(d_{n_1})| < |\psi(d_{m_0}) \wedge \psi(d_{m_1})|$.

Finally, for any $n < m$,

$$\psi(d_m)(|\psi(d_n)|) = g(\phi(d_m))(|g(\phi(d_n))|) = f(\phi(d_m))(|g(\phi(d_n))|)$$

as $g(\phi(d_m)) \succ f(\phi(d_m))$. By Item 3 $\phi(d_m)$ is chosen so that

$$f(\phi(d_m))(|\psi(d_n)|) = d_m(|d_n|). \quad \square$$

COROLLARY 6.17 (ACA₀). *Let \mathcal{G} be a Joyce Rado graph, and \mathcal{F} be a (finite or infinite) Joyce graph. Then, there exists an embedding from \mathcal{F} to \mathcal{G} .*

PROOF. By Theorem 6.9, we can assume that \mathcal{G} is a coded Joyce Rado graph. By Theorem 6.14, there is an embedding of a Joyce blossom graph \mathcal{B} to \mathcal{G} . By Theorem 6.16, there is an embedding of \mathcal{F} to \mathcal{B} . Thus there is an embedding of \mathcal{F} to \mathcal{G} . \square

Recall that the *age* of a graph \mathcal{G} is the collection of all finite graphs that are isomorphic to a subgraph of \mathcal{G} .

COROLLARY 6.18. *The age of a Joyce Rado graph is the set of finite Joyce graphs.*

THEOREM 6.19. *There is a computable Joyce Rado graph \mathcal{G} such that for every Joyce blossom graph \mathcal{B} , every embedding of \mathcal{B} to \mathcal{G} computes \mathcal{V}' .*

PROOF. The idea of the proof is to build a Joyce Rado graph with domain G such that if $S \subseteq 2^{<\omega}$ is a cofinal set with at most one meet of each length, $f : 2^{<\omega} \rightarrow G^\wedge$ and $g : 2^{<\omega} \rightarrow G$ form a blossom tree, and $\sigma, \tau \in 2^{<\omega}$ are such that $|g(\sigma) \wedge g(\tau)| > 3j$, then $\mathcal{V}'(j) = 1$ iff $g(\sigma)(3j+2) = g(\tau)(3j+2)$ iff $g(\tau)(3j+2) = g(\tau)(3j+2)$.

Let (G_0, E) be a Rado graph, and let $(g_n)_{n \in \omega}$ be an enumeration of G_0 , and $(\mathcal{V}'_s)_{s \in \omega}$ a computable approximation of \mathcal{V}' . Define σ_n to be the unique string of length $3n+2$ such that:

- (1) $\sigma_n(3n) = 0$ and $\sigma_n(3n+1) = 1$;
- (2) for any $j < n$, $\sigma_n(3j+1) = 0$ and
 - (a) if $\mathcal{V}'_n(j) = 0$ and $g_n E g_j$ then $\sigma_n(3j) = 0$ and $\sigma_n(3j+2) = 1$,
 - (b) if $\mathcal{V}'_n(j) = 0$ and $\neg g_n E g_j$ then $\sigma_n(3j) = 1$ and $\sigma_n(3j+2) = 0$,
 - (c) if $\mathcal{V}'_n(j) = 1$ and $g_n E g_j$ then $\sigma_n(3j) = 1$ and $\sigma_n(3j+2) = 1$,
 - (d) if $\mathcal{V}'_n(j) = 1$ and $\neg g_n E g_j$ then $\sigma_n(3j) = 0$ and $\sigma_n(3j+2) = 0$.

Let $G = \{\sigma_n : n \in \mathbb{N}\}$. It is clear that (G, E_{pn}) is a Rado graph, as it is in bijection with G_0 via $g_n \mapsto \sigma_n$ since $g_n E g_m$ iff $\sigma_n E_{\text{pn}} \sigma_m$. Define $\llbracket \sigma_n, \sigma_m \rrbracket = v(\sigma_n \wedge \sigma_m)$ where v is a fixed injective function $2^{<\omega} \rightarrow \omega$ such that if $|\sigma| < |\tau|$ then $v(\sigma) < v(\tau)$. Then by construction, $\mathcal{G} = (G, E_{\text{pn}}, <_{\text{lex}}, \llbracket \cdot, \cdot \rrbracket)$ is a Joyce Rado graph.

Now, suppose that $f : 2^{<\omega} \rightarrow G^\wedge$ and $g : 2^{<\omega} \rightarrow G$ form a Joyce blossom graph. The claim is the following: if $\sigma, \tau \in 2^{<\omega}$ are such that $|g(\sigma) \wedge g(\tau)| > 3j$, then $\emptyset'(j) = 1$ iff $g(\sigma)(3j+2) = g(\sigma)(3j+2)$ iff $g(\tau)(3j+2) = g(\tau)(3j+2)$.

Indeed, recall that $g(\sigma) \wedge g(\tau) = f(\sigma) \wedge f(\tau)$. Let $\rho \succ \sigma$ be such that $|g(\rho)| \geq 3n+2$ where $\emptyset'_n(j) = \emptyset'(j)$. By construction, $g(\rho)(3j) = g(\rho)(3j+2)$ iff $\emptyset'_n(j) = 1$ iff $\emptyset'(j) = 1$. As $\rho \succ \sigma$, we have $g(\rho) \succ f(\sigma) \prec g(\sigma)$ so finally $g(\sigma)(3j) = g(\sigma)(3j+2)$ iff $\emptyset'(j) = 1$.

Therefore, given g , to know the value of $\emptyset'(j)$, it suffices to find $\sigma, \tau \in S$ such that $|g(\sigma) \wedge g(\tau)| > 3j$, and answer according to whether $g(\sigma)(3j) = g(\sigma)(3j+2)$. \square

COROLLARY 6.20. *Corollary 6.17 implies ACA_0 .*

6.3. A proof of the Rado Graph theorem

DEFINITION 6.21. A *Joyce graph diagonalization* for some Joyce graph $(U, E_U, <_U, \llbracket \cdot, \cdot \rrbracket_U)$ is a function $h : 2^{<\omega} \rightarrow U$, such that for every coded Joyce graph X , $(h[X], E_U, <_U, \llbracket \cdot, \cdot \rrbracket_U)$ is isomorphic to X .

THEOREM 6.22 (RCA_0). *There exists a Joyce Rado graph $(2^{<\omega}, E_T, <_T, \llbracket \cdot, \cdot \rrbracket_T)$ such that for every coded Joyce order X , the Joyce structures of $(X, E_T, <_T, \llbracket \cdot, \cdot \rrbracket_T)$ and $(X, E_{\text{pn}}, <_{\text{lex}}, | \cdot \wedge \cdot |)$ are isomorphic.*

PROOF. Let $(U, E_{\text{pn}}, <_{\text{lex}}, \llbracket \cdot, \cdot \rrbracket_U)$ be the Joyce Rado graph defined in Theorem 6.3, that is, $U = (000 \cup 101)^*01$ and $\llbracket \sigma, \tau \rrbracket_U = v(\sigma \wedge \tau)$ for some injective function $v : 2^{<\omega} \rightarrow \omega$ such that for every $\sigma, \tau \in 2^{<\omega}$, if $|\sigma| < |\tau|$ then $v(\sigma) < v(\tau)$.

Define the Joyce Rado graph $(2^{<\omega}, E_{\text{pn}}, <_T, \llbracket \cdot, \cdot \rrbracket_T)$ as follows: Given $\sigma \in 2^{<\omega}$, let $\hat{\sigma}$ be the binary string of length $3|\sigma| + 2$ defined for every $j < |\sigma|$ by $\hat{\sigma}(3j) = \sigma(j)$, $\hat{\sigma}(3j+1) = \hat{\sigma}(3j+2) = 0$, and $\hat{\sigma}(3|\sigma|) = 0$ and $\hat{\sigma}(3|\sigma|+1) = 1$. For instance, if $\sigma = 0110$ then $\hat{\sigma} = 00010010000001$. Then let $\sigma <_T \tau$ if and only if $\hat{\sigma} <_{\text{lex}} \hat{\tau}$ and $\llbracket \sigma, \tau \rrbracket_T = \llbracket \hat{\sigma}, \hat{\tau} \rrbracket_U$.

Let X be a coded Joyce order. We claim that $(X, E_{\text{pn}}, <_T, \llbracket \cdot, \cdot \rrbracket_T)$ and $(X, E_{\text{pn}}, <_{\text{lex}}, | \cdot \wedge \cdot |)$ are isomorphic.

Fix $\sigma, \tau \in X$. If $\sigma <_{\text{lex}} \tau$, then $\hat{\sigma} <_{\text{lex}} \hat{\tau}$, hence $\sigma <_T \tau$. Conversely, if $\sigma <_T \tau$, then $\hat{\sigma} <_{\text{lex}} \hat{\tau}$, but since σ and τ are incomparable with respect to the prefix relation, this implies that $\sigma <_{\text{lex}} \tau$. Thus $\sigma <_T \tau$ if and only if $\sigma <_{\text{lex}} \tau$.

Fix $\sigma, \tau, \rho, \mu \in X$. If $|\sigma \wedge \tau| <_{\mathbb{N}} |\rho \wedge \mu|$, then $|\hat{\sigma} \wedge \hat{\tau}| <_{\mathbb{N}} |\hat{\rho} \wedge \hat{\mu}|$, then $v(\hat{\sigma} \wedge \hat{\tau}) <_{\mathbb{N}} v(\hat{\rho} \wedge \hat{\mu})$, hence $\llbracket \sigma, \tau \rrbracket_T <_{\mathbb{N}} \llbracket \rho, \mu \rrbracket_T$. Conversely, assume $\llbracket \sigma, \tau \rrbracket_T <_{\mathbb{N}} \llbracket \rho, \mu \rrbracket_T$. Unfolding the definition, $v(\hat{\sigma} \wedge \hat{\tau}) <_{\mathbb{N}} v(\hat{\rho} \wedge \hat{\mu})$. If $|\hat{\sigma} \wedge \hat{\tau}| \neq |\hat{\rho} \wedge \hat{\mu}|$, then by definition of v , $|\hat{\sigma} \wedge \hat{\tau}| <_{\mathbb{N}} |\hat{\rho} \wedge \hat{\mu}|$, hence $|\sigma \wedge \tau| <_{\mathbb{N}} |\rho \wedge \mu|$. If $|\hat{\sigma} \wedge \hat{\tau}| = |\hat{\rho} \wedge \hat{\mu}|$, then since X is a coded Joyce graph, $\sigma \wedge \tau = \rho \wedge \mu$, so $\hat{\sigma} \wedge \hat{\tau} = \hat{\rho} \wedge \hat{\mu}$ and $v(\hat{\sigma} \wedge \hat{\tau}) = v(\hat{\rho} \wedge \hat{\mu})$, contradiction. \square

COROLLARY 6.23 (ACA_0). *Every Joyce Rado graph $(U, E_U, <_U, \llbracket \cdot, \cdot \rrbracket_U)$ has a Joyce graph diagonalization.*

PROOF. Let $(2^{<\omega}, E_T, <_T, \llbracket \cdot, \cdot \rrbracket_T)$ be the Joyce Rado graph of Theorem 6.22. By Corollary 6.17, there is an embedding $h : 2^{<\omega} \rightarrow U$. By definition of an embedding, for every coded Joyce graph $X \subseteq 2^{<\omega}$, $(h[X], E_U, <_U, \llbracket \cdot, \cdot \rrbracket_U)$ is isomorphic to $(X, E_T, <_T, \llbracket \cdot, \cdot \rrbracket_T)$. By Theorem 6.22, $(X, E_T, <_T, \llbracket \cdot, \cdot \rrbracket_T)$ is isomorphic to $(X, E_{\text{pn}}, <_{\text{lex}}, | \cdot \wedge \cdot |)$. Thus h is a Joyce graph diagonalization. \square

In the case of Joyce blossom graphs, the existence of a Joyce graph diagonalization holds in RCA_0 ;

COROLLARY 6.24 (RCA_0). *Every Joyce blossom graph has a Joyce graph diagonalization.*

PROOF. Similar to the proof of Corollary 6.23, but apply Theorem 6.16 instead of Corollary 6.17. \square

LEMMA 6.25. *Let F be a finite coded Joyce graph of size n and $T \in \mathcal{S}_\omega(2^{<\omega})$. Then every $E \in \mathcal{S}_{2n-1}(T)$ contains at most one coded Joyce graph isomorphic to F . Moreover, every coded Joyce graph $H \subseteq T$ isomorphic to F is included in some $E \in \mathcal{S}_{2n-1}(T)$.*

PROOF. The proof is a straightforward adaptation of Lemma 5.21, *mutatis mutandis*. \square

THEOREM 6.26 (ACA_0). *Let \mathcal{G} be a Joyce Rado structure, and \mathcal{F} be a finite Joyce graph. Then, the big Ramsey number of \mathcal{F} in \mathcal{G} is 1.*

PROOF. Let X be a countable coded Joyce Rado graph and F be a finite coded Joyce Rado graph of size n . Fix a coloring $f : \binom{X}{F} \rightarrow k$. Here, $\binom{X}{F}$ denotes all the subcopies of F in X .

Let $h : 2^{<\omega} \rightarrow X$ be a Joyce graph diagonalization, which exists by Corollary 6.23. Let $g : \mathcal{S}_n(2^{<\omega}) \rightarrow k$ be defined for every $E \in \mathcal{S}_{2n-1}(2^{<\omega})$ by $g(E) = f(h(H))$ where $H \subseteq E$ is the unique element coded Joyce graph isomorphic to F , if it exists. Otherwise let $g(E) = 0$. This coloring is well-defined by Lemma 5.21.

By Milliken's tree theorem for height $2n - 1$, there is a strong subtree $S \in \mathcal{S}_\omega(2^{<\omega})$ such that g restricted to $\mathcal{S}_{2n-1}(S)$ is monochromatic for some color $i < k$. In particular, by Lemma 6.25, for every coded Joyce graph $H \subseteq S$ isomorphic to F , there is some $E \in \mathcal{S}_{2n-1}(S)$ containing H , and $g(E) = f(h(H)) = i$.

Since $S \in \mathcal{S}_\omega(2^{<\omega})$, there is an injective function $\phi : 2^{<\omega} \rightarrow S$ such that $\phi[X]$ is a coded Joyce graph isomorphic to X . In particular, since h is a Joyce graph diagonalization, $Y = h[\phi[X]]$ is a coded Joyce Rado graph isomorphic to X , hence a subcopy of X .

We claim that f restricted to $\binom{Y}{F}$ is monochromatic for color i . Let \hat{H} be a copy of F in $Y = h[\phi[X]]$. Let $H \subseteq \phi[X]$ be such that $h[H] = \hat{H}$. In particular since $\phi[X]$ is a coded Joyce graph, so is H , so since h is a Joyce graph diagonalization, $\hat{H} = h[H]$ is a coded Joyce graph isomorphic to H .

In other words, H is a copy of F in $\phi[X] \subseteq S$, so H is a copy of F in S . By choice of S , $f(h[H]) = i$, so $f(\hat{H}) = i$. This completes the proof of Theorem 6.26. \square

COROLLARY 6.27 (ACA₀). *The statement $(\forall k)\text{JRG}_{k, J_n}^n$ holds, where J_n is the number of non isomorphic Joyce graph structure with n elements, while $(\forall k)\text{JRG}_{k, J_{n-1}}^n$ does not hold.*

PROOF. Let ℓ be the number of Joyce graph with n elements. Let $F_0, \dots, F_{\ell-1}$ be a finite enumeration of all the finite coded Joyce graph structures of size n .

We first prove that $\text{JRG}_{k, \ell}^n$ holds. Fix a coloring $f : [X]^n \rightarrow k$ for some countable Joyce Rado graph structure $(X, E, <, \mathbb{R})$. By Theorem 5.22, build a finite decreasing sequence of subsets $X = X_0 \supseteq X_1 \supseteq \dots \supseteq X_\ell$ of X such that for every $s < \ell$:

- (1) $(X_{s+1}, E, <, \mathbb{R})$ is a subcopy of $(X_s, E, <, \mathbb{R})$;
- (2) every copy of F in $(X_{s+1}, E, <, \mathbb{R})$ is monochromatic for f for some color $i_s < k$

The Joyce graph structure $(X_\ell, E, <, \mathbb{R})$ is a subcopy of $(X, <, \mathbb{R})$. Moreover, for every $E \in [X_\ell]^n$, $(E, <, \mathbb{R})$ is isomorphic to F_s for some $s < \ell$, so $f(E) = i_s$. It follows that $f[X_\ell]^n \subseteq \{i_s : s < \ell\}$, hence $|f[X_\ell]^n| \leq \ell$.

We now show that the bound is tight. Let $f : [X]^n \rightarrow k$ be defined by $f(H) = s$ for the unique $s < \ell$ such that $(H, E, <, \mathbb{R})$ is isomorphic to F_s . Let $(Y, E, <, \mathbb{R})$ be a subcopy of $(X, E, <, \mathbb{R})$. In particular, $(Y, E, <, \mathbb{R})$ is a Joyce Rado graph structure, so by Corollary 6.17, for every $s < \ell$, there is an embedding of F_s into $(Y, E, <, \mathbb{R})$. Therefore, $|f[Y]^n| \geq \ell$. \square

THEOREM 6.28 (ACA₀). *Let $\mathcal{G} = (G, E, <, \mathbb{R})$ be a Joyce graph structure. Let $\mathcal{G}' = (g', E)$ be an isomorphic subcopy of (G, E) , that is, a Rado graph. Then, there exists a subcopy (G'', E) of (\mathcal{G}', E) such that $(G'', E, <, \mathbb{R})$ is a subcopy of \mathcal{G} .*

PROOF. The structure $\hat{\mathbb{X}}' = (X', E, <, \mathbb{R})$ is a Joyce Rado graph structure, even if it might not be isomorphic to \mathbb{X} . By Corollary 6.17, there exists an embedding of \mathbb{X} into $\hat{\mathbb{X}}'$. The image of the embedding is \mathbb{X}'' . \square

Note that contrary to the case of Joyce orders, for which the proof that Devlin's theorem implies the Joyce Devlin theorem holds in RCA₀, the following corollary holds in ACA₀. The difference comes from proof of Corollary 6.17 which is more complex than Theorem 5.16.

COROLLARY 6.29 (ACA₀). *The Rado Graph theorem for n -tuples and ℓ colors implies the Joyce Rado graph theorem for n -tuples and ℓ colors.*

COROLLARY 6.30 (ACA₀). *The tight bound for the Rado graph theorem and the Joyce Rado graph theorem for n elements are the same, that is, the number of Joyce graph structures with n elements.*

PROOF. Let b_0 and b_1 be the tight bound for the Rado graph theorem and the Joyce Rado graph theorem for n elements, respectively.

We first claim that $b_0 \leq b_1$. Let (X, E) be a Rado graph. By Corollary 6.4, one can enrich this graph with an order $<$ and a relation R so that $(X, E, <, R)$ is a Joyce Rado graph structure. Let $f : [X]^n \rightarrow k$ be a coloring. By choice of b_1 , there is a Joyce subcopy $(Y, E, <, R)$ of $(X, E, <, R)$ such that $|f[Y]^n| \leq b_1$. In particular, (Y, E) is a subcopy of (X, E) so $b_0 \leq b_1$.

We then claim that $b_1 \leq b_0$. Let $(X, E, <, R)$ be a Joyce Rado graph structure. Let $f : [X]^n \rightarrow k$ be a coloring. By choice of b_0 , there is a subcopy (Y, E) of (X, E) such that $|f[Y]^n| \leq b_0$. By Theorem 6.28, there is a subcopy (Z, E) of (Y, E) such that $(Z, E, <, R)$ is a Joyce subcopy of $(X, E, <, R)$. In particular, $|f[Z]^n| \leq b_0$. Thus $b_1 \leq b_0$.

It follows that $b_0 = b_1$. Moreover, by Corollary 5.24, this tight bound is the number of Joyce graph structures with n elements. \square

6.4. Cone avoidance of the Rado Graph theorem for pairs

THEOREM 6.31. *Fix two sets C and Z such that $C \not\leq_T Z$. Let*

$$\mathcal{B} = (B, E_{\text{pn}}, <_{\text{lex}}, |\cdot \wedge \cdot|)$$

be a Z -computable Joyce blossom graph. For every Z -computable function $f : [B]^2 \rightarrow k$, there exists a subcopy $(U, E_{\text{pn}}, <_{\text{lex}}, |\cdot \wedge \cdot|)$ of \mathcal{B} and a finite set of colors $I \subseteq k$ such that $C \not\leq_T U \oplus Z$, $|I| \leq 4$, and

$$(\forall \ell_0)(\forall^\infty \ell_1)(\forall^\infty \ell_2)[f[U(\ell_0, \ell_1, \ell_2)]^2 \subseteq I],$$

where $U(\ell_0, \ell_1, \ell_2)$ is the set of Joyce subgraphs of size 2 whose labels are exactly ℓ_0, ℓ_1, ℓ_2 , that is, $U(\ell_0, \ell_1, \ell_2) = \{\{\sigma, \tau\} \in [U]^2 : |\sigma \wedge \tau| = \ell_0, |\sigma| = \ell_1, |\tau| = \ell_2\}$.

PROOF. By Corollary 6.24, there is a Z -computable Joyce graph diagonalization $h : 2^{<\omega} \rightarrow B$. Let $\mathcal{F}_0, \mathcal{F}_1, \mathcal{F}_2, \mathcal{F}_3$ be the 4 Joyce graph structures of size 2.

For every $j < k$, let $g_j : \mathcal{S}_3(2^{<\omega}) \rightarrow k$ be defined for every $E \in \mathcal{S}_3(2^{<\omega})$ by $g_j(E) = f(h(H))$ where $H \subseteq E$ is the unique element coded Joyce graph isomorphic to \mathcal{F}_j , if it exists. Otherwise let $g_j(E) = 0$. This coloring is well-defined by Lemma 5.21.

By 4 successive applications of Theorem 4.11, there exists a strong subtree $R \in \mathcal{S}_\omega(2^{<\omega})$ such that for each $j < 4$, g_j restricted to $\mathcal{S}_3(R)$ is stable. For each $j < 4$, let $\hat{g}_j : \mathcal{S}_2(R) \rightarrow k$ be the (non-computable) limit coloring of g_j .

Again, by 4 successive applications of Theorem 4.11, there exists a strong subtree $S \in \mathcal{S}_\omega(R)$ such that for each $j < 4$, \hat{g}_j restricted to $\mathcal{S}_2(S)$ is stable. For each $j < 4$, let $\mu_j : S \rightarrow k$ be the (non-computable) limit coloring of \hat{g}_j .

Last, by 4 successive applications of Theorem 3.21, there exists a strong subtree $T \in \mathcal{S}_\omega(S)$ such that for each $j < 4$, μ_j restricted to T is monochromatic for some color $i_j < 4$. Let $I = \{i_j : j < 4\}$.

In particular, by Lemma 6.25, for every coded Joyce graph $H \subseteq T$ isomorphic to \mathcal{F}_j , there is some $E \in \mathcal{S}_3(S)$ containing H , and $g_j(E) = f(h(H))$.

Let $(X, E_{\text{pn}}, <_{\text{lex}}, |\cdot \wedge \cdot|)$ be a Z -computable coded Joyce graph isomorphic to \mathcal{B} , which exists by Theorem 6.9. Since $T \in \mathcal{S}_\omega(2^{<\omega})$, there is an injective function $\phi : 2^{<\omega} \rightarrow T$ such that $\phi[X]$ is a coded Joyce graph isomorphic to X , hence to \mathcal{B} . In particular, since h is a Joyce graph diagonalization, $U = h[\phi[X]]$ is a coded Joyce Rado graph isomorphic to X , hence a subcopy of \mathcal{B} .

We claim that the statement of the theorem holds for U , f and I . Given any $\ell \in \omega$, there is at most one level $n \in \omega$ such that for every $\sigma, \tau \in T$ with $|\sigma \wedge \tau| = n$, $|h(\phi(\sigma)) \wedge h(\phi(\tau))| = \ell$. We call n the *preimage* of ℓ . Moreover, if ℓ is a label of U , that is, there is some $\rho, \nu \in U$ such that $|\rho \wedge \nu| = \ell$, then it has a preimage.

Fix $\ell_0 \in \omega$. If ℓ_0 has no preimage, then $U(\ell_0, \ell_1, \ell_2) = \emptyset$ for every ℓ_1, ℓ_2 and the property is vacuously satisfied. Let n_0 be the preimage of ℓ_0 . Since for every $j < 4$, \hat{g}_j is stable over $\mathcal{S}_\omega(T)$ with limit color i_j , there is some threshold $t_0 \in \omega$ such that for every strong subtree E of U of height 2 whose first level is n_0 and second is higher than t_0 , $\hat{g}_j(E) = i_j$. For all but finitely many ℓ_1 , the preimage of ℓ_1 , if it exists, is larger than t_0 . Fix any such ℓ_1 with preimage n_1 . For every $j < 4$, since \hat{g}_j is the limit coloring of g_j , there is a threshold $t_1 \in \omega$ such that for every strong subtree E of height 3 whose first two levels are n_0 and n_1 , respectively, and whose last level is higher than t_1 , $g_j(E) = i_j$. For all but finitely many ℓ_2 , its preimage is larger than t_1 .

Fix any such ℓ_2 , and let $\hat{H} \in U(\ell_0, \ell_1, \ell_2)$. Let $j < 4$ be such that \hat{H} is isomorphic to \mathcal{F}_j . Let $H \subseteq \phi[X]$ be such that $h[H] = \hat{H}$. In particular since $\phi[X]$ is a coded Joyce graph, so is H , so since h is a Joyce graph diagonalization, $\hat{H} = h[H]$ is a coded Joyce graph isomorphic to H . In other words, H is a copy of \hat{H} in $\phi[X] \subseteq T$, so H is a copy of \mathcal{F}_j in T . By choice of T , $f(h[H]) = i_j$, so $f(\hat{H}) = i_j \in I$. This completes the proof of Theorem 6.31. \square

THEOREM 6.32. $(\forall k) \text{RG}_{k,4}^2$ admits cone avoidance.

PROOF. Fix two sets Z, C such that $C \not\leq_T Z$. Let (V, E) be a Z -computable Rado graph and $h : [V]^2 \rightarrow k$ be a Z -computable coloring.

By computable categoricity of the Rado graph, (V, E) is Z -computably isomorphic to the graph of a computable Joyce blossom graph

$$\mathcal{B} = (B, E_{\text{pn}}, <_{\text{lex}}, |\cdot \wedge \cdot|).$$

This induces a Z -computable coloring $\hat{h} : [B]^2 \rightarrow k$ by composing the coloring h with the isomorphism. By Theorem 6.31, there is a subcopy $(U, E_{\text{pn}}, <_{\text{lex}}, |\cdot \wedge \cdot|)$ of \mathcal{B} and a finite set of colors $I \subseteq k$ such that $C \not\leq_T U \oplus Z$,

$|I| \leq 4$, and

$$(6.1) \quad (\forall \ell_0)(\forall^\infty \ell_1)(\forall^\infty \ell_2)[\hat{h}[U(\ell_0, \ell_1, \ell_2)]^2 \subseteq I],$$

where $U(\ell_0, \ell_1, \ell_2)$ is the set of Joyce subgraphs of size 2 whose labels are exactly ℓ_0, ℓ_1, ℓ_2 , that is, $U(\ell_0, \ell_1, \ell_2) = \{\{\sigma, \tau\} \in [U]^2 : |\sigma \wedge \tau| = \ell_0, |\sigma| = \ell_1, |\tau| = \ell_2\}$. Let (f, g) be a $U \oplus Z$ -computable blossom tree and $D \subseteq 2^{<\omega}$ be a Z -computable set cofinal in $2^{<\omega}$ such that $g[D] = B$. In particular, by Equation (6.1), the following holds:

$$(6.2) \quad (\forall \rho \in 2^{<\omega})(\forall^\infty \sigma_0 \in D)(\forall^\infty \sigma_1 \in D)[\sigma_0 \wedge \sigma_1 = \rho \Rightarrow \hat{h}(g(\sigma_0), g(\sigma_1)) \in I].$$

We are going to build a by forcing infinite set $G \subseteq D$ such that $(g[G], E_{\text{pn}})$ is a Rado graph and $\hat{h}[g[G]]^2 \subseteq I$.

DEFINITION 6.33. A string $\sigma \in 2^{<\omega}$ *witnesses* a finite 2-partition $F_0 \sqcup F_1 \subseteq 2^{<\omega}$ if for every $i < 2$ and every $\rho \in F_i$, $\sigma(|\rho|) = i$.

In other words, σ witnesses $F_0 \sqcup F_1 \subseteq 2^{<\omega}$ if in the graph $(2^{<\omega}, E_{\text{pn}})$, σ is connected to all the elements of F_1 and disconnected from all the elements of F_0 . Note that if σ witnesses $F_0 \sqcup F_1 \subseteq D$, then so does any $\tau \succeq \sigma$.

LEMMA 6.34. *If (G, E_{pn}) is a Rado graph for some $G \subseteq D$, then so is $(g[G], E_{\text{pn}})$.*

PROOF. Let $\hat{F}_0 \sqcup \hat{F}_1 \subseteq g[G]$ be a finite 2-partition. Let $F_0 = g^{-1}[\hat{F}_0]$ and $F_1 = g^{-1}[\hat{F}_1]$. In particular, F_0 and F_1 are disjoint. Since (G, E_{pn}) is a Rado graph, then there is some $\sigma \in G$ witnessing the 2-partition $F_0 \sqcup F_1 \subseteq G$. We claim that $g(\sigma)$ witnesses the 2-partition $\hat{F}_0 \sqcup \hat{F}_1 \subseteq g[G]$. By definition of a blossom tree (f, g) , the function f is \wedge -preserving, so $f(\sigma)$ witnesses the 2-partition $\hat{F}_0 \sqcup \hat{F}_1 \subseteq g[G]$. Since $g(\sigma) \succeq f(\sigma)$, then so does $g(\sigma)$. \square

Given $\sigma \in 2^{<\omega}$, we write $D \upharpoonright 2^{<\omega} = \{\tau \in D : \tau \succeq \sigma\}$. Given a finite set $R \subseteq 2^{<\omega}$, we write $D \upharpoonright R = \{\tau \in D : (\exists \sigma \in R)[\tau \succeq \sigma]\}$.

DEFINITION 6.35. A *condition* is a pair (F, R) where $F \subseteq D$ and $R \subseteq 2^{<\omega}$ are both finite sets such that R is prefix-free and:

- (1) every finite 2-partition $F_0 \sqcup F_1 = F$ is witnessed by some $\sigma \in R$;
- (2) for every $\sigma \in F$ and $\tau \in F \cup (D \upharpoonright R)$, $\hat{h}(g(\sigma), g(\tau)) \in I$;

A condition (E, S) *extends* (F, R) (written $(E, S) \leq (F, R)$) if $F \subseteq E$, $E \setminus F \subseteq D \upharpoonright R$ and for every $\tau \in S$, there is some $\sigma \in R$ such that $\tau \succeq \sigma$.

One can see a condition (F, R) as the Mathias condition $(F, D \upharpoonright R)$. In particular, for every filter \mathcal{F} for this notion of forcing, letting $G_{\mathcal{F}} = \bigcup\{F : (F, R) \in \mathcal{F}\}$, if $(F, R) \in \mathcal{F}$ then $F \subseteq G_{\mathcal{F}} \subseteq F \cup (D \upharpoonright R)$. Structurally, we ensured that $\hat{h}[g[G_{\mathcal{F}}]]^2 \subseteq I$. Note that $(\emptyset, \{\epsilon\})$ is a valid condition.

LEMMA 6.36. *For every condition (F, R) , $(F \cup (D \upharpoonright R), E_{\text{pn}})$ is a Rado graph.*

PROOF. Fix any finite 2-partition $E_0 \sqcup E_1 \subseteq F \cup D \upharpoonright R$. By definition of a condition, there is some $\sigma \in R$ witnessing the 2-partition $E_0 \cap F, E_1 \cap F$. Since D is cofinal in $2^{<\omega}$, there is some $\tau \in D$ such that $\tau \succeq \sigma$, and for every $i < 2$ and $\rho \in E_i \setminus F$, $\tau(|\rho|) = i$. Thus τ witnesses the 2-partition $E_0 \sqcup E_1 \subseteq F \cup D \upharpoonright R$. Moreover $\tau \in D \upharpoonright \sigma$, hence $\tau \in D \upharpoonright R$. \square

The following lemma shows that if \mathcal{F} is a sufficiently generic filter, then $(G_{\mathcal{F}}, E_{\text{pn}})$ is a Rado graph.

LEMMA 6.37. *For every condition (F, R) and every 2-partition $F_0 \sqcup F_1 \subseteq F$, an extension (E, S) such that E contains an element witnessing the 2-partition.*

PROOF. Let $\ell_0 \in \omega$ be larger than the length of any string in R . Let $\ell_1 \in \omega$ be sufficiently large with respect to ℓ so that

$$(6.3) \quad (\forall \rho \in 2^{\leq \ell_0})(\forall \sigma_0 \in D^{\geq \ell_1})(\forall \sigma_1 \in D)[\sigma_0 \wedge \sigma_1 = \rho \Rightarrow \hat{h}(g(\sigma_0), g(\sigma_1)) \in I].$$

Such an ℓ_1 exists by Equation (6.2). Let \hat{R} be obtained from R by extending each string $\sigma \in R$ into a string τ of length ℓ_1 such that $\tau(\ell_0) = 0$. Then (F, \hat{R}) is again a condition.

By Lemma 6.36, since $(F \cup (D \upharpoonright \hat{R}), E_{\text{pn}})$ is a Rado graph, there is some $\tau \in F \cup (D \upharpoonright \hat{R})$ witnessing the 2-partition. If $\tau \in F$ then we are done since (F, \hat{R}) then satisfies the lemma, so assume $\tau \in D \upharpoonright \hat{R}$. Let $E = F \cup \{\tau\}$. Since $|\tau| \geq \ell_1$, by Equation (6.3), there is some $\ell_2 \in \omega$ so that

$$(6.4) \quad (\forall \rho \in 2^{\leq \ell_0})(\forall \mu \in D^{\geq \ell_2})[\tau \wedge \mu = \rho \Rightarrow \hat{h}(g(\tau), g(\mu)) \in I].$$

For every $\sigma \in R$, let $\sigma_0, \sigma_1 \in R$ be strings of length at least ℓ_2 such that $\sigma_0(|\tau|) = 0$, $\sigma_1(|\tau|) = 1$, $\sigma_0(\ell_0) = \sigma_1(\ell_0) = 1$, $\sigma_0 \wedge \sigma_1 \succeq \sigma$, and define $S = \{\sigma_0, \sigma_1 : \sigma \in R\}$.

We claim that (E, S) is a condition. We first prove Item (1). Let $F_0 \sqcup F_1 \subseteq E$ be a 2-partition. Since (F, R) is a condition, there is some $\sigma \in R$ witnessing the 2-partition $(F_0 \setminus \{\tau\}) \sqcup (F_1 \setminus \{\tau\})$. If $\tau \in F_i$ for some $i < 2$, then $\sigma_i \succeq \sigma$ witnesses the 2-partition $F_0 \sqcup F_1 \subseteq E$. If $\tau \notin F_0 \sqcup F_1$, then any $\sigma_i \succeq \sigma$ witnesses it.

We now prove Item (2). Fix $\nu \in E$ and $\mu \in E \cup (D \upharpoonright S)$ with $|\nu| \leq |\mu|$. If $\nu \neq \tau$, then $\nu \in F$ and $\hat{h}(g(\nu), g(\mu)) \in I$ by Item (2) for (F, R) . If $\nu = \tau$, then $\mu \in (D \upharpoonright S)$. By choice of S , $\mu(\ell_0) = 1$, and $\nu(\ell_1) = 0$. Thus, $|\mu \wedge \nu| \leq \ell_0$. Moreover, since every string in S has length at least ℓ_2 , $|\mu| \geq \ell_2$, so by Equation (6.4), $\hat{h}(g(\nu), g(\mu)) \in I$. \square

DEFINITION 6.38. Let $c = (F, R)$ be a condition and let $\varphi(G, x)$ be a $\Delta_0^{0, Z}$ formula with a free set parameter G and a free integer parameter x .

1. $c \Vdash (\exists x)\varphi(G, x)$ if $\varphi(F, x)$ holds for some $x \in \omega$;
2. $c \Vdash (\forall x)\varphi(G, x)$ if $\varphi(F \cup E, x)$ holds for every $x \in \omega$ and every $E \subseteq D \upharpoonright R$ such that $\hat{h}[g[E]]^2 \subseteq I$.

In particular, the forcing relation is closed under extension, and if \mathcal{F} is a filter and $c \Vdash \varphi(G)$ for some $\Sigma_1^{0,Z}$ or $\Pi_1^{0,Z}$ formula and some $c \in \mathcal{F}$, then $\varphi(G_{\mathcal{F}})$ actually holds. As usual, we write $c \Vdash \Gamma^{G \oplus Z} \neq C$ if either $c \Vdash \Gamma^{G \oplus Z}(x) \uparrow$ or $c \Vdash \Gamma^{G \oplus Z}(x) \downarrow \neq C(x)$ for some $x \in \omega$.

LEMMA 6.39. *For every condition c and every Turing functional Γ , there is an extension d of c such that $d \Vdash \Gamma^{G \oplus Z} \neq C$.*

PROOF. As in the proof of Lemma 6.37, let ℓ_0 and ℓ_1 be sufficiently large to satisfy Equation (6.3). Again, let \hat{R} be obtained from R by extending each string $\sigma \in R$ into a string τ of length ℓ_1 such that $\tau(\ell_0) = 0$.

Let W be the set of all pairs $(x, v) \in \omega \times 2$ such that there is a finite set $E \subseteq D \upharpoonright \hat{R}$ satisfying $\hat{h}[g[E]]^2 \subseteq I$ and such that $\Phi^{(F \cup E) \oplus Z}(x) \downarrow = v$. Note that the set W is Z -c.e. We have three cases.

Case 1: $(x, 1 - C(x)) \in W$ for some $x \in \omega$. Let $E \subseteq D \upharpoonright \hat{R}$ witness that $(x, 1 - C(x)) \in W$, that is, $\hat{h}[g[E]]^2 \subseteq I$ and $\Phi^{(F \cup E) \oplus Z}(x) \downarrow = 1 - C(x)$. Since for every $\tau \in E$, $|\tau| \geq \ell_1$, then by Equation (6.3), there is some $\ell_2 \in \omega$ so that

$$(6.5) \quad (\forall \rho \in 2^{\leq \ell_0})(\forall \tau \in E)(\forall \mu \in D^{\geq \ell_2})[\tau \wedge \mu = \rho \Rightarrow \hat{h}(g(\tau), g(\mu)) \in I].$$

For every $\sigma \in R$, and every 2-partition $E_0 \sqcup E_1 = E$, let σ_{E_0, E_1} be a string of length at least ℓ_2 extending σ , such that $\sigma_{E_0, E_1}(\tau) = 0$ for every $\tau \in E_0$ and $\sigma_{E_0, E_1}(\tau) = 1$ for every $\tau \in E_1$. Let $S = \{\sigma_{E_0, E_1} : \sigma \in R, E_0 \sqcup E_1 = E\}$.

We claim that $(F \cup E, S)$ is a condition. We first prove Item (1). Let $(F_0 \cup E_0) \sqcup (F_1 \cup E_1) \subseteq F \cup E$ be a 2-partition with $F_0 \sqcup F_1 \subseteq F$ and $E_0 \sqcup E_1 \subseteq E$. Since (F, R) is a condition, there is some $\sigma \in R$ witnessing the 2-partition $F_0 \sqcup F_1 \subseteq F$. By construction, $\sigma_{E_0, E_1} \in S$ witnesses the 2-partition $E_0 \sqcup E_1 \subseteq E$ and extends σ , so σ_{E_0, E_1} witnesses the 2-partition $(F_0 \cup E_0) \sqcup (F_1 \cup E_1) \subseteq F \cup E$.

We now prove Item (2). Fix $\nu \in F \cup E$ and $\mu \in F \cup E \cup (D \upharpoonright S)$ with $|\nu| \leq |\mu|$. If $\nu \in F$, then $\hat{h}(g(\nu), g(\mu)) \in I$ by Item (2) for (F, R) . If $\nu \in E$ and $\mu \in F \cup E$, then $\mu \in E$ since $|\nu| \leq |\mu|$, and $\hat{h}(g(\nu), g(\mu)) \in I$ since $\hat{h}[g[E]]^2 \subseteq I$. If $\nu \in \tau$ and $\mu \in (D \upharpoonright S)$, then by choice of S , $\mu(\ell_0) = 1$, and $\nu(\ell_1) = 0$. Thus, $|\mu \wedge \nu| \leq \ell_0$. Moreover, since every string in S has length at least ℓ_2 , $|\mu| \geq \ell_2$, so by Equation (6.5), $\hat{h}(g(\nu), g(\mu)) \in I$.

Moreover, the condition $(F \cup E, S)$ forces $\Phi^{G \oplus Z}(x) \downarrow = 1 - C(x)$, thus satisfies the lemma.

Case 2: $(x, C(x)) \notin W$ for some $x \in \omega$. Then the condition (F, \hat{R}) is an extension of (F, R) forcing $\Phi^{G \oplus Z}(x) \uparrow \vee \Phi^{G \oplus Z}(x) \downarrow \neq C(x)$, and we are done.

Case 3: *otherwise.* Then W is a Z -c.e. graph of the characteristic function of C , hence C is Z -computable, contradicting the hypothesis. This case therefore cannot happen. This completes the proof of Lemma 6.39. \square

We are now ready to prove Theorem 6.32. Let \mathcal{F} be a sufficiently generic filter for this notion of forcing. By definition of a forcing condition, $\hat{h}[g[F]]^2 \subseteq I$ for every $(F, R) \in \mathcal{F}$, so $\hat{h}[g[G_{\mathcal{F}}]]^2 \subseteq I$. By Lemma 6.39, $C \not\leq_T G_{\mathcal{F}} \oplus Z$. Since $g \leq_T Z$ then $C \not\leq_T g[G_{\mathcal{F}}] \oplus Z$. By Lemma 6.37, $(G_{\mathcal{F}}, E_{\text{pn}})$ is a Rado graph, and by Lemma 6.34, so is $(g[G_{\mathcal{F}}], E_{\text{pn}})$. The image of $(g[G_{\mathcal{F}}], E_{\text{pn}})$ be the Z -computable isomorphism between the Rado graph (V, E) and the Joyce blossom graph \mathcal{B} yields a Rado subgraph (\hat{V}, E) of (V, E) such that $h[\hat{V}]^2 \subseteq I$ and $C \not\leq_T \hat{V} \oplus Z$. This completes the proof of Theorem 6.32. \square

COROLLARY 6.40. $(\forall k) \text{RG}_{k,4}^2$ does not imply ACA_0 over RCA_0 .

PROOF. Immediate by Theorem 6.32 and Lemma 2.15. \square

6.5. Lower bound on the Rado Graph theorem

In order to show lower bounds, we use the notion of Joyce blossom graph: Indeed, one can computably embed any Joyce graph in a Joyce blossom graph by Theorem 6.16, and there is a computable one by Lemma 6.12. The embeddings of a Joyce complete graph with order type \mathbb{N} or \mathbb{Q} allow to show that $\text{JRG}_{8,7}^2$ implies respectively RT_2^2 and the Devlin Theorem. Even though it is weaker, We include the proof of RT_2^2 from $\text{JRG}_{8,7}^2$ as it yields a computable reduction.

THEOREM 6.41. For every k, n , the statement $\text{JRG}_{4k,4n+3}^2$ implies $\text{RT}_{k,n}^2$. In particular, $\text{JRG}_{8,7}^2$ implies RT_2^2 .

PROOF. We first give the insight about what $4n + 3$ corresponds to: if the union of 4 disjoint sets is of cardinality $4n + 3$, then one of them is of cardinality at most N .

CLAIM 6.42. There exists a Joyce graph $(G, E, <, \llbracket \cdot, \cdot \rrbracket)$ such that (G, E) is the complete graph and for all $a, b \in G$, $a < b \iff \llbracket a, a \rrbracket < \llbracket b, b \rrbracket$.

PROOF. Let $G = \{1^{2n}0 : n \geq 1\}$, then $(G, E_{\text{pn}}, <_{\text{lex}}, | \cdot \wedge \cdot |)$ is a witness of the claim. \square

Let $f : \mathbb{N}^2 \rightarrow k$ be a symmetric coloring. By Lemma 6.12, let $\mathcal{G} = (G, E, <, \llbracket \cdot, \cdot \rrbracket)$ be a computable Joyce blossom graph.

Let $(\mathcal{F}_i)_{i < 4}$ be an enumeration of the finite Joyce graph structures with two elements. If $a, b \in G$, define $g(a, b) = (f(\llbracket a, a \rrbracket, \llbracket b, b \rrbracket), i)$ where i is such that $\{a, b\}$ is isomorphic to \mathcal{F}_i . By $\text{JRG}_{<\infty, 2n+1}^2$, let \mathcal{G}' be a subcopy of \mathcal{G} in \mathcal{G} , using at most $4n+3$ colors. Either $\{(a, b) : aEb\}$ or $\{(a, b) : \neg aEb\}$ uses at most $2n+1$ colors, suppose for instance that it is the former. Similarly, either $\{(a, b) : a < b \wedge \llbracket a, a \rrbracket < \llbracket b, b \rrbracket \wedge aEb\}$ or $\{(a, b) : a < b \wedge \llbracket a, a \rrbracket > \llbracket b, b \rrbracket \wedge aEb\}$ uses at most n colors, suppose that it is the former. By Claim 6.42 there exists a Joyce complete graph \mathbb{K} such that for all $a, b \in \mathbb{K}$, $a < b \iff \llbracket a, a \rrbracket < \llbracket b, b \rrbracket$. By Theorem 6.16, there exists a computable subcopy \mathcal{G}'' of

\mathbb{K} inside \mathcal{G}' . In particular, \mathcal{G}'' uses at most n colors for g . As a consequence, $\{\llbracket a, a \rrbracket : a \in \mathcal{G}''\}$ uses at most n colors for f . \square

THEOREM 6.43. *For every n, k , the statement $\text{JRG}_{2k, 2n+1}^2$ implies $\text{DT}_{k, n}^2$ and thus $\text{JRG}_{8, 7}^2$ implies ACA_0 .*

PROOF. We start with a claim.

CLAIM 6.44. *There exists a Joyce graph $(G, E, <, \llbracket \cdot, \cdot \rrbracket)$ such that (G, E) is the complete graph and $(G, <)$ is a DLO.*

PROOF. Let $(G, <, \llbracket \cdot, \cdot \rrbracket)$ be a DLO Joyce order. Define $E = \{(a, b) : a, b \in G\}$. Then $(G, E, <, \llbracket \cdot, \cdot \rrbracket)$ is a witness of the claim. \square

Let $\mathbb{X} = (X, <_X)$ be a computable dense linear order with no endpoints, and $f : X^2 \rightarrow k$ be a symmetric coloring. By Lemma 6.12, let \mathcal{G} be a computable Joyce blossom graph. In particular, there exists an embedding e from $(G, <_{\text{lex}})$ to \mathbb{X} .

If $a, b \in G$, define $g(a, b) = (f(e[\{a; b\}]), 1)$ if aEb and

$$g(a, b) = (f(e[\{a; b\}]), 0)$$

if $\neg aEb$. By $\text{JRG}_{< \infty, 2n+1}^2$, let \mathcal{G}' be a subcopy of \mathcal{G} in \mathcal{G} , using at most $2n+1$ colors. Either $\{(a, b) : aEb\}$ or $\{(a, b) : \neg aEb\}$ uses at most n colors, suppose for instance that it is the former. By Claim 6.44 there exists a Joyce complete graph \mathbb{K} whose order is a DLO. By Theorem 6.16, there exists a computable subcopy \mathcal{G}'' of \mathbb{K} inside \mathcal{G}' . In particular, \mathcal{G}'' is a DLO and uses at most n colors for g . As a consequence, $e[\mathcal{G}''] \subseteq \mathbb{X}$ is a DLO and uses at most n colors for f .

Thus, $\text{JRG}_{8, 7}^2$ implies $\text{DT}_{4, 3}^2$ which implies ACA_0 . \square

Larson [28] computed the big Ramsey number for small subgraphs of the Rado graph. The sum of the big Ramsey numbers for subgraphs of size 3 is equal to the number of Joyce graphs of size 3, that is, 112. In other words, $(\forall k)\text{RG}_{k, 112}^3$ holds, while $(\forall k)\text{RG}_{k, 111}^3$ does not. In the particular case of the complete graph K_3 of size 3, $(\forall k)\text{RG}_{k, 16}^{K_3}$ holds, while $(\forall k)\text{RG}_{k, 15}^{K_3}$ does not.

The proof technique for the following theorem stems from Jockusch [23] who constructed a computable instance of Ramsey's theorem for triples whose solutions compute the halting set. It was later refined by Hirschfeldt and Jockusch [21, Theorem 2.1] who showed the existence of a computable such instance such that every solution is of PA degrees over \emptyset' . Although it is unknown whether the Rado graph statement for graphs of size n implies Ramsey's theorem for n -tuples, we can adapt the argument of Hirschfeldt and Jockusch to graphs.

THEOREM 6.45. *Let (G, E) be a computable Rado graph and F be a finite graph of size 3. Let $b \in \omega$ be the Ramsey degree of F in the Rado graph theorem, that is, the number of Joyce graphs isomorphic to F . There exists a computable coloring $f : \binom{G}{F} \rightarrow 2b$, such that for every $\hat{G} \subseteq G$ for*

which (\hat{G}, E) is a Rado graph and f restricted to (\hat{G}_F) has at most b colors, \hat{G} is of PA degree over \emptyset' .

PROOF. By Corollary 6.4, there exists an order $<$ over G and a function $\llbracket \cdot, \cdot \rrbracket : G^2 \rightarrow \omega$ such that $(G, E, <, \llbracket \cdot, \cdot \rrbracket)$ is a Joyce Rado graph. Let J_0, \dots, J_{b-1} be an enumeration of all the Joyce graph structures of size 3 isomorphic to F . Let $g : (\hat{G}_F) \rightarrow 2b$ be the coloring which to $\{x, y, z\}$ associates the index $i < b$ so that the Joyce graph structure of $(\{x, y, z\}, E, <, \llbracket \cdot, \cdot \rrbracket)$ is isomorphic of J_i .

Let $h : [\omega]^3 \rightarrow 2$ be defined for every $x < y < z$ by $h(x, y, z) = 1$ iff for every $e < x$, $\Phi_e^{\emptyset'[y]}(e)[y] = \Phi_e^{\emptyset'[z]}(e)[z]$. Last, let $f : (\hat{G}_F) \rightarrow 2 \times b$ be defined by

$$f(x, y, z) = (h(\llbracket x, x \rrbracket, \llbracket y, y \rrbracket, \llbracket z, z \rrbracket), g(x, y, z)).$$

Let $\hat{G} \subseteq G$ be such that (\hat{G}, E) is a Rado graph and f restricted to (\hat{G}_F) has at most b colors.

CLAIM 6.46. $f(\hat{G}_F) = \{(1, i) : i < b\}$.

PROOF. Let $H \subseteq \hat{G}$ be a (non-computable) set such that (H, E) is a Rado graph, and H is sparse enough so that for every $x, y \in H$ such that $\llbracket x, x \rrbracket <_{\mathbb{N}} \llbracket y, y \rrbracket$, then for every $e < x$ such that $\Phi_e^{\emptyset'}(e) \downarrow$, $\Phi_e^{\emptyset'[y]}(e)[y] \downarrow$. In particular, $\{\llbracket x, x \rrbracket : x \in H\}$ is h -homogeneous for color 1. By Corollary 6.17, for every $i < b$, J_i embeds into $(H, E, <, \llbracket \cdot, \cdot \rrbracket)$, so for every $i < b$, there is a unique $j < 2$ such that $(j, i) \in f(\hat{G}_F)$. Moreover, by sparsity of H , $j = 1$. Thus $\{(1, i) : i < b\} \subseteq f(\hat{G}_F) \subseteq f(\hat{G}_F)$, and by cardinality, $f(\hat{G}_F) = \{(1, i) : i < b\}$. \square

Let F_0 be the finite graph induced by the two first elements of F .

CLAIM 6.47. For every $\{x, y\} \in (\hat{G}_{F_0})$ with $\llbracket x, x \rrbracket <_{\mathbb{N}} \llbracket y, y \rrbracket <_{\mathbb{N}} \llbracket z, z \rrbracket$, and every $e < \llbracket x, x \rrbracket$, if $\Phi_e^{\emptyset'}(e) \downarrow$ then $\Phi_e^{\emptyset'[\llbracket y, y \rrbracket]}(e)[\llbracket y, y \rrbracket] \downarrow$

PROOF. Since \hat{G} is a Rado graph, we can find a z with $\llbracket z, z \rrbracket$ sufficiently large such that $\{x, y, z\} \in (\hat{G}_F)$ and for every $e < \llbracket x, x \rrbracket$, if $\Phi_e^{\emptyset'}(e) \downarrow$ then $\Phi_e^{\emptyset'[\llbracket z, z \rrbracket]}(e)[\llbracket z, z \rrbracket] \downarrow$. By Claim 6.46, $h(\llbracket x, x \rrbracket, \llbracket y, y \rrbracket, \llbracket z, z \rrbracket) = 1$, so by definition of h , for every $e < \llbracket x, x \rrbracket$, $\Phi_e^{\emptyset'[\llbracket y, y \rrbracket]}(e)[\llbracket y, y \rrbracket] = \Phi_e^{\emptyset'[\llbracket z, z \rrbracket]}(e)[\llbracket z, z \rrbracket]$. In particular, if $\Phi_e^{\emptyset'}(e) \downarrow$ then $\Phi_e^{\emptyset'[\llbracket y, y \rrbracket]}(e)[\llbracket y, y \rrbracket] \downarrow$. \square

We are now ready to prove that \hat{G} is of PA degree relative to \emptyset' . For this, we prove that \hat{G} computes a completion of the universal partial \emptyset' -computable function $e \mapsto \Phi_e^{\emptyset'}(e)$. Given e , search \hat{G} -computably for a pair $\{x, y\} \in (\hat{G}_{F_0})$ such that $e < \llbracket x, x \rrbracket$, and return $\Phi_e^{\emptyset'[\llbracket y, y \rrbracket]}(e)[\llbracket y, y \rrbracket]$ if it halts, otherwise return 0. Such a pair $\{x, y\}$ is always found since \hat{G} is a Rado graph. By Claim 6.47, if $\Phi_e^{\emptyset'[\llbracket y, y \rrbracket]}(e)[\llbracket y, y \rrbracket]$ does not halt, then $\Phi_e^{\emptyset'}(e) \uparrow$, so this is a valid completion. This completes the proof of Theorem 6.45. \square

COROLLARY 6.48. *For every finite graph F of size 3, letting b be the number of Joyce graphs isomorphic to F , $(\forall k)\text{RG}_{k,b}^F$ implies ACA_0 over RCA_0 .*

COROLLARY 6.49. *$(\forall k)\text{RG}_{k,16}^{K_3}$ implies ACA_0 over RCA_0 .*

THEOREM 6.50. *For every $n \geq 1$, every finite graph F of size n , let b_n be the tight bound of $(\forall k)\text{RG}_{k,b_n}^n$ and c_n be the tight bound of $(\forall k)\text{RG}_{k,c_n}^F$, that is, b_n is the number of Joyce graphs of size n and c_n is the number of Joyce graphs isomorphic to F . Then $(\forall k)\text{RG}_{k,b_n}^n$ implies $(\forall k)\text{RG}_{k,c_n}^F$ over RCA_0 .*

PROOF. Let $f : \binom{G}{F} \rightarrow k$ be an instance of $(\forall k)\text{RG}_{k,c_n}^F$. Let $g : [G]^n \rightarrow b_n$ be the coloring witnessing the tightness of the bound b_n . In particular, g restricted to $\binom{G}{F}$ uses exactly c_n many colors. Given $H \in [G]^n$, let $h(H) = (g(H), f(H))$ if the graph H is isomorphic to F , and $h(H) = (g(H), \perp)$ otherwise. By $(\forall k)\text{RG}_{k,b_n}^n$, there is a Rado subgraph $\hat{G} \subseteq G$ such that $h[\hat{G}]^n$ has at most b_n colors. By choice of g , for every $i < b_n$, there is some v such that $(i, v) \in h[\hat{G}]^n$. Thus for every $i < b_n$, there is exactly one v such that $(i, v) \in h[\hat{G}]^n$. In particular, f restricted to $\binom{\hat{G}}{F}$ has at most b_n many colors. \square

COROLLARY 6.51. *$(\forall k)\text{RG}_{k,112}^3$ implies ACA_0 over RCA_0 .*

PROOF. Immediate by Corollary 6.48 and Theorem 6.50. 112 is the tight bound for the Rado graph theorem for triples, and 16 the tight bound for the Rado graph theorem restricted to the complete graph of size 3. \square

We do not know whether $(\forall k)\text{RG}_{k,4}^2$ implies RT_2^2 over RCA_0 . Theorem 6.55 however is a partial result towards that direction. Ramsey's theorem for pairs RT_k^2 was decomposed by Cholak, Jockusch and Slaman [3] into a stability version (SRT_k^2) and a cohesiveness principle (COH) in order to simplify the computability-theoretic analysis of the theorem.

DEFINITION 6.52. An infinite set C is *cohesive* for a sequence of sets $R_0, R_1, \dots \subseteq \mathbb{N}$ if for every n , $C \subseteq^* R_n$ or $C \subseteq^* \overline{R}_n$. A coloring $f : [\omega]^2 \rightarrow k$ is *stable* if for every x , $\lim_y f(x, y)$ exists.

STATEMENT 6.53 (Cohesiveness). COH is the statement "Every countable sequence of set has an infinite cohesive set".

STATEMENT 6.54 (Stable Ramsey's theorem for pairs). SRT_k^2 is the restriction of RT_k^2 to stable colorings.

Cholak, Jockusch and Slaman [3, Lemma 7.11] and Mileti [29, Corollary A.1.4] proved the equivalence between RT_k^2 and $\text{SRT}_k^2 \wedge \text{COH}$ over RCA_0 . The following theorem shows that $(\forall k)\text{RG}_{k,4}^2$ implies SRT_2^2 , hence any proof of separation would be a proof of separation of $(\forall k)\text{RG}_{k,4}^2$ from COH.

THEOREM 6.55. *$\text{RG}_{8,4}^2$ implies SRT_2^2 over RCA_0 .*

PROOF. Let $f : [\omega]^2 \rightarrow 2$ be a stable coloring. Fix a computable coded Joyce Rado graph $(G, <_{\text{lex}}, E_{\text{pn}}, |\cdot \wedge \cdot|)$, let F_0, F_1, F_2, F_3 be the 4 Joyce graphs of size 2, and define an instance $g : [G]^2 \rightarrow 4 \times 2$ of $\text{RG}_{8,4}^2$ by $g(\{\sigma, \tau\}) = (i, f(\{|\sigma|, |\tau|\}))$ where F_i is the unique Joyce graph isomorphic to $(\{\sigma, \tau\}, <_{\text{lex}}, E_{\text{pn}}, |\cdot \wedge \cdot|)$.

Let $H \subseteq G$ be a $\text{RG}_{8,4}^2$ -solution to g , that is, (H, E_{pn}) is a Rado graph and $|g[H]^2| \leq 4$. By Corollary 6.17, for every $i < 4$, there is an embedding from F_i to $(H, <_{\text{lex}}, E_{\text{pn}}, |\cdot \wedge \cdot|)$, so for every $i < 4$, there is a unique value $v(i) < 2$ such that $(i, v(i)) \in g[H]^2$. Thus $g[H]^2 = \{(i, v(i)) : i < 4\}$.

CLAIM 6.56. $g[H]^2 = \{(i, j) : i < 4\}$ for some $j < 2$.

PROOF. Fix $i_0 < i_1 < 4$. We need to show that $v(i_0) = v(i_1)$. By Corollary 6.17, there is an embedding h of a Joyce blossom graph B in $(H, <_{\text{lex}}, E_{\text{pn}}, |\cdot \wedge \cdot|)$. One can find some $\sigma \in B$, $\tau_0, \tau_1 \in B$ such that $\{\sigma, \tau_0\}, <_{\text{lex}}, E_{\text{pn}}, |\cdot \wedge \cdot|$ and $\{\sigma, \tau_1\}, <_{\text{lex}}, E_{\text{pn}}, |\cdot \wedge \cdot|$ are isomorphic to F_{i_0} and F_{i_1} , respectively. Then $g(\{h(\sigma), h(\tau_0)\}) = (i_0, v(i_0))$ and $g(\{h(\sigma), h(\tau_1)\}) = (i_1, v(i_1))$, so $f(\{h(\sigma), h(\tau_0)\}) = v(i_0)$ and $f(\{h(\sigma), h(\tau_1)\}) = v(i_1)$. Moreover, τ_0 and τ_1 can be chosen so that $|h(\tau_0)|$ and $|h(\tau_1)|$ is large enough to witness stability of $\lim_s f(|h(\sigma)|, s)$. Then $f(\{h(\sigma), h(\tau_0)\}) = v(i_0) = f(\{h(\sigma), h(\tau_1)\}) = v(i_1)$. \square

Let $j < 2$ be such that Claim 6.56 holds. It follows that $Y = \{|\sigma| : \sigma \in H\}$ is f -homogeneous for color j . This completes the proof of Theorem 6.55. \square

We now prove that for every $\ell \geq 1$, RT_2^2 does not imply $(\forall k)\text{RG}_{k,\ell}^2$ over RCA_0 . For this, we need two essential notions in computability theory, namely, lowness and hyperimmunity. Lowness is a weakness property over Turing degrees, saying informally that a low Turing degree behaves like the computable Turing degree from the viewpoint of the halting set. Hyperimmunity is a strength property about the ability to compute fast-growing functions, not dominated by any computable function.

DEFINITION 6.57. A set A is *low* if $A' \equiv_T \emptyset'$. A set A is *low relative to* X for a set X if $(A \oplus X)' \equiv_T X'$.

DEFINITION 6.58. A function $f : \mathbb{N} \rightarrow \mathbb{N}$ is *hyperimmune* relative to X if it is not dominated by any X -computable function. An infinite set $H \subseteq \mathbb{N}$ is *hyperimmune* relative to X if its principal function, that is, the function which to n associates the n th element of H , is hyperimmune relative to X .

THEOREM 6.59. *Let P be low relative to \emptyset' . For every ℓ , there exists a computable instance of $\text{RG}_{\ell+1,\ell}^2$ with no solution computable in P .*

PROOF. We first need the following definition and lemma to build the instance.

LEMMA 6.60. *There exists a Δ_3^0 coloring $g : \mathbb{N} \rightarrow \ell + 1$ such that for every $k \leq \ell$, the set $A_k = \{n \in \mathbb{N} : g(n) \neq k\}$ is hyperimmune relative to P .*

PROOF. We prove that there exists a Δ_2^0 coloring $g : \mathbb{N} \rightarrow \ell + 1$ such that for all k , $\{n : g(n) \neq k\}$ is hyperimmune. The relativization to P of this proof yields the result of the lemma, as a Δ_2^0 relative to P is a Δ_3^0 set by lowness relative to \emptyset' of P .

We build uniformly in \emptyset' a sequence σ_s of compatible strings of increasing length. Start with σ_0 the empty string. Suppose σ_s is defined, with $s = (k, e)$. Let $n_s = |\{i < |\sigma_s| : \sigma_s(i) \neq k\}|$. Using \emptyset' , we can decide if $\varphi_e(n_s) \downarrow$. If so we define σ_{s+1} to be σ_s followed by the string consisting of $\varphi_e(n_s) + 1$ times k . Otherwise, σ_{s+1} is σ_s followed by 0.

Define $g = \bigcup_s \sigma_s$. By construction, for $s = (k, e)$, σ_{s+1} diagonalizes against φ_e dominating $\{n \in \mathbb{N} : g(n) \neq k\}$. Thus, for any $k < \ell$, $\{n \in \mathbb{N} : g(n) \neq k\}$ is hyperimmune. \square

Fix g as in the lemma. Let $(g_{s,t})_{s,t \in \mathbb{N}}$ be a Δ_3^0 approximation of g . One can always arrange the approximation so that for every s, t , $g_{s,t}$ is a coloring of \mathbb{N} in $\ell + 1$ colors. Let $\mathbb{G} = (G, E_{\text{pn}})$ with $G \subseteq 2^{<\omega}$ a coded Rado graph. Define f to be the following: for every $\sigma, \tau \in 2^{<\omega}$ with $|\sigma| < |\tau|$,

$$f(\sigma, \tau) = g_{|\sigma|, |\tau|}(|\sigma \wedge \tau|)$$

Let $S \subseteq 2^{<\omega}$ be such that (S, E_{pn}) is a Rado graph, and f takes at most ℓ colors on $[S]^2$. Let k be the avoided color. We prove that S computes a function bounding the principal function of A_k , so by hyperimmunity relative to P of A_k , P cannot compute S .

Let $h \leq_T S$ be the function so that $h(n)$ is the smallest such that $S \cap 2^{<h(n)}$ has n elements. We prove that for every n , A_k contains at least n elements smaller than $h(n)$. Indeed, let e_0, \dots, e_{n-1} be the n elements of $S \cap 2^{<h(n)}$. Let $(\tau_j)_{j < 2^n}$ be an enumeration of the set 2^n , we say that a string ρ realize τ_j if for all $i < n$ ($\rho E_{\text{pn}} e_i \iff \tau_j(i) = 1$), note that for any j there are infinitely many elements of S realizing τ_j , so there are some of arbitrarily big length. Let ρ_0 be the first element of S such that $g_s(m) = g(m)$ for all $s \geq |\rho_0|$ and $m < h(n)$, and ρ_0 realizes τ_0 . If ρ_j is defined, then define ρ_{j+1} to be the first element of S realizing τ_{j+1} such that for all $t \geq |\rho_{j+1}|$, $g_{|\rho_j|, t}(m) = g(m)$ for all $m < h(n)$.

This defines 2^n many different strings ρ_j and thus $2^n - 1$ many meets, which must be of height below $h(n)$ by construction: given ρ_{j_0}, ρ_{j_1} , they must differ at $|e_i|$ for some $i < n$ such that $\tau_{j_0}(i) \neq \tau_{j_1}(i)$. Moreover, as $\rho_j \in S$ for all j , if $|\rho_{j_0}| < |\rho_{j_1}|$, we have $g_{|\rho_{j_0}|, |\rho_{j_1}|}(|\rho_{j_0} \wedge \rho_{j_1}|) \neq k$, but also $g_{|\rho_{j_0}|, |\rho_{j_1}|}(|\rho_{j_0} \wedge \rho_{j_1}|) = g(|\rho_{j_0} \wedge \rho_{j_1}|)$ as $|\rho_{j_0} \wedge \rho_{j_1}| < h(n)$.

Thus, for every $j_0 \neq j_1 < 2^n$, $|\rho_{j_0} \wedge \rho_{j_1}| \in A_k$ and is below $h(n)$. There are $2^n - 1 > n$ many such meet. So h is a function computable in S that dominates the principal function of A_k . As A_k is hyperimmune relative to P , P cannot compute h , and so cannot compute S . \square

LEMMA 6.61 (Simpson [40, Theorem 6.5]). *For every pair of sets A and C such that A is of PA degree over C , there is a set B such that A is PA over B and B is PA over C .*

PROOF. Fix a universal Π_1^0 class functional $\mathcal{C} \subseteq 2^\omega$ such that for every X , $\mathcal{C}^X \neq \emptyset$ and all the members of \mathcal{C}^X are of PA degree relative to X . For example, take \mathcal{C}^X to be the class of all $\{0, 1\}$ -valued DNC functions relative to X . Then the class $\mathcal{D} = \{B \oplus Z : B \in \mathcal{C}^C \text{ and } Z \in \mathcal{C}^B\}$ is a non-empty $\Pi_1^{0,C}$ class. In particular, A computes some $B \oplus Z \in \mathcal{D}$, and since Z is of PA degree relative to B and B is of PA degree relative to C , the result follows. \square

LEMMA 6.62. *For every set P of PA degree over \emptyset' , there exists an ω -model Mc of RT_2^2 such that for every $X \in Mc$, $X' \leq_T P$.*

PROOF. Fix P . We inductively define $A_0, A_1, \dots \subseteq \mathbb{N}$ as follows. Let $A_0 = \emptyset$, and suppose we have defined A_s for some $s \in \mathbb{N}$ and that P is of PA degree above A'_s . By Lemma 6.61, there is some Q such that P is PA relative to Q and Q is PA relative to A'_s . If $s \neq (e, t)$ for some $e \in \mathbb{N}$ and some $t < s$, or if $\Phi_e^{A_t}$ is not a coloring $f : [\omega]^2 \rightarrow 2$, then let $A_{s+1} = A_s$. Otherwise, by Cholak, Jockusch and Slaman [3] (see Hirschfeldt [20, Corollary 6.58] for an explicit formulation), there is an infinite f -homogeneous set H such that $(H \oplus A_s)' \leq_T Q$. Let $A_{s+1} = A_s \oplus H$. In particular, $A'_{s+1} \leq_T Q$, so P is of PA degree over A'_{s+1} . \square

Let $\mathcal{S} = \{Z : (\exists s)[Z \leq_T A_s]\}$, which is a Turing ideal since $A_t \leq_T A_s$ for all $t \leq s$. By construction, if $f : [\omega]^2 \rightarrow 2$ is any instance of RT_2^2 in \mathcal{S} then \mathcal{S} contains a solution to f . (Indeed, if $f = \Phi_e^{A_t}$, say, let $s = (e, t)$; then a solution to X is computable from A_{s+1} .) It follows that $Mc = (\mathbb{N}, \mathcal{S})$ is a model of $\text{RCA}_0 \wedge \text{RT}_2^2$, and by construction, for every $X \in \mathcal{S}$, $X' \leq_T P$. \square

We are now ready to prove our separation theorem.

THEOREM 6.63. *For every $\ell \geq 1$, RT_2^2 does not imply $(\forall k)\text{RG}_{k,\ell}^2$ over RCA_0 .*

PROOF. By the low basis theorem relativized to \emptyset' (see Jockusch and Soare [25, Theorem 2.1]), there is a set P of PA degree over \emptyset' , such that $P' \leq_T \emptyset''$. By Lemma 6.62, there is an ω -model Mc of RT_2^2 such that for every $X \in Mc$, $X' \leq_T P$. By Theorem 6.59, there is a computable instance f of $(\forall k)\text{RG}_{k,\ell}^2$ with no P -computable solution. In particular, $f \in Mc$, but Mc does not contain a solution to f , so Mc is not a model of $(\forall k)\text{RG}_{k,\ell}^2$. \square

CHAPTER 7

A generalized tree theorem

In this chapter, we study the principle $\text{CHMTT}_{k,l}^n$ stating that given a k -coloring of $[2^{<\omega}]^n$, there is a subtree $S \subseteq 2^{<\omega}$ such that (S, \preceq) is isomorphic to $(2^{<\omega}, \preceq)$ and such that $[S]^n$ uses at most l colors. Note that we do not require S to be a strong subtree of T or even S to be meet-closed — thus enlarging a bit for this chapter the original definition of a tree given with definition 2.16.

The existence for every n of a finite big Ramsey degree associated with these structures — a smallest number l_n such that CHMTT_{k,l_n}^n holds for every k — easily follows from the Milliken's tree theorem. We will try to identify more precisely the specific values of these big Ramsey degrees l_n , a new sequence of numbers, which does not seem to have appeared before in combinatorics.

In order to pursue this study, we introduce first a simpler principle, for which we now require the subtree to be a strong subtree.

THEOREM 7.1 (Strong generalized CHM tree theorem). *For every $n \geq 1$ there exists $\ell \geq 1$ such that for every $k \geq 1$ and every $f : [2^{<\omega}]^n \rightarrow k$ there is a strong subtree $S \subseteq 2^{<\omega}$ such that $|f([S]^n)| \leq \ell$.*

STATEMENT 7.2. We call $\text{SCHMTT}_{k,l}^n$ the statement of the Strong generalized CHM tree theorem.

Note that both $\text{SCHMTT}_{k,l}^n$ and $\text{CHMTT}_{k,l}^n$ would work exactly the same way if we start from a coloring of any perfect tree T rather than $2^{<\omega}$: via an isomorphism between T and $2^{<\omega}$, the theorem applied to $2^{<\omega}$ also gives via the isomorphism a solution for T . We start by introducing the notion of embedding types, useful in the conduct of our study.

7.1. Embedding types

We shall try to identify what can be used by a coloring of $[2^{<\omega}]^n$ to identify some structure one will never be able to remove in any strong subtree. A first step for that is the identification of the concept of embedding type, for which we introduce the following preliminary notions.

DEFINITION 7.3. Let S be a set of strings.

- (1) S is *meet-closed* if for every $\sigma, \tau \in S$, $\sigma \wedge \tau \in S$.
- (2) S is *level-closed* if for every $\sigma, \tau \in S$, $\tau \upharpoonright |\sigma| \in S$.

We will be interested in finite trees which are both meet-closed and level closed.

DEFINITION 7.4 (closure). Let S be a set of strings.

- (1) The *meet closure* of S is the set $S^\wedge = \{\sigma \wedge \tau : \sigma, \tau \in S\}$.
- (2) The *level closure* of S is the set $S^{\text{lvl}} = \{\sigma \upharpoonright |\tau| : \sigma, \tau \in S\}$.
- (3) The *full closure* of S is the set $S^{\text{cl}} = (S^\wedge)^{\text{lvl}}$.

Note that $S \subseteq S^\wedge$ and $S \subseteq S^{\text{lvl}}$ by taking $\sigma = \tau$ in the above definitions. Any strong subtree of $2^{<\omega}$ is meet-closed and level-closed but not conversely, as witnessed by the following example $S = \{\epsilon; 0; 00; 01; 1; 11\}$. In Figure 7.1, we give an example of a subtree, and its full closure.

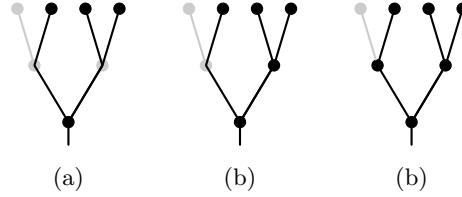

FIGURE 7.1. The set of nodes (a) is level-closed but not meet-closed. The set of nodes (b) is the meet-closure of (a). Note that it is now not level-closed. The set of nodes (c) is the level-closure of (b) which corresponds to the full closure of (a).

The idea is the following: given a set of strings $S = \{\sigma_1, \dots, \sigma_n\} \in [2^{<\omega}]^n$, one can easily compute the tree S^{cl} . A coloring can then identify which *type* of tree arise from S and give a different color to each of them. The number of these type is defined below as the *embedding types* that we now formally define.

DEFINITION 7.5. Two finite fully closed trees $F_0, F_1 \subseteq 2^{<\omega}$ are *strongly isomorphic* if there is a bijection $f : F_0 \rightarrow F_1$ such that $\sigma i \preceq \tau \leftrightarrow f(\sigma) i \preceq f(\tau)$ for any $\sigma, \tau \in F_0$. The *embedding types* are the equivalence classes of the strong isomorphism relation on finite fully closed trees.

Any embedding type has a minimal element with respect its height. We usually use this minimal element as a canonical representative of the class.

Figures 7.2 to 7.4 illustrate the notion of embedding types. Figure 7.2 consists of example of different embedding types. Figure 7.3 shows several level-closed subtrees with the same embedding type. Figure 7.4 illustrates the height of an embedding type.

7.2. Strong generalized CHM tree theorem

No embedding type can be avoided in a strong subtree of $2^{<\omega}$. For this reason the number of colors that cannot be avoided by n -tuples of elements

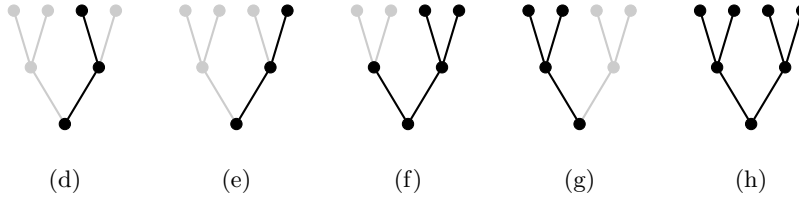

FIGURE 7.2. A few embedding types of height 3, the underlying grey tree being $2^{<\omega}$. All of them are different.

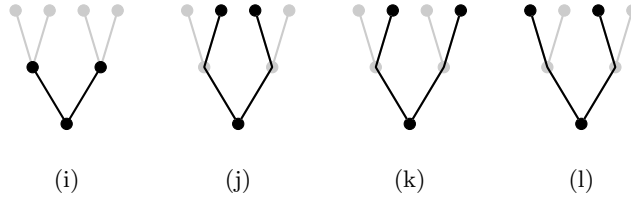

FIGURE 7.3. A few finite level-closed subtrees with the same embedding type. The fact that they are level-closed depends on the underlying grey tree.

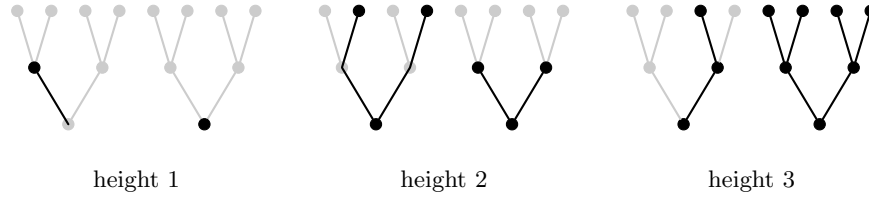

FIGURE 7.4. Some subtrees with embedding type of different height. The two first have the same embedding type, the unique embedding type of height 1. The two in the middle have the same embedding type, of height 2. The last pair consists of level-closed subtrees with two different embedding types of height 3.

of $2^{<\omega}$ is at least the number of embedding types that can be generated by these tuples.

DEFINITION 7.6. Let $e_{sTT} : \omega \rightarrow \omega$ be the function which to n associates the number of embedding types that can be generated by n distinct strings.

Let us provide an example with Figure 7.5: all the possible embedding types that are generated by two strings. We have $e_{sTT}(2) = 7$.

Given an element of $[2^{<\omega}]^n$ one can computably recognize which embedding type it generates. It follows that given an enumeration $\epsilon_1, \epsilon_2, \dots, \epsilon_{e_{sTT}(n)}$ of the embedding types that can be generated by n distinct strings, one can define the color c on $[2^{<\omega}]^n$ which to each element generating the embedding type ϵ_i associates i . No strong subtree of $2^{<\omega}$ can avoid any embedding type

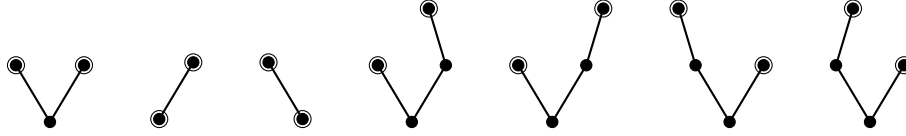

FIGURE 7.5. The seven possible embedding types generated by two nodes (shown as circled). That is, these are the embedding types of their full closure. The maximal height of the embedding types here is 3.

and thus at least $e_{sTT}(n)$ colors are used by c within any strong subtree of $2^{<\omega}$.

We can in fact force even more colors: Given a finite strong subtree $F \subseteq 2^{<\omega}$, there might be distinct tuples $\bar{\sigma}_1, \bar{\sigma}_2 \in [F]^n$ such that $\bar{\sigma}_1^{cl} = \bar{\sigma}_2^{cl} = F$. Note that such a phenomenon does not happen for $n = 2$ and below, but start to happen from $n = 3$. For instance the tuples $\{\sigma 0, \sigma 1, \sigma 00\}$ and $\{\sigma, \sigma 1, \sigma 00\}$ generate the same embedding type. This leads to the following definition:

DEFINITION 7.7. A *tuple type* is an equivalence class on the following relation defined on $\bigcup_n [2^{<\omega}]^n \times [2^{<\omega}]^n$: We say that $\bar{\sigma}, \bar{\tau} \in [2^{<\omega}]^n$ are equivalent if there is a strong isomorphism f from $\bar{\sigma}^{cl}$ to $\bar{\tau}^{cl}$ which associates elements of $\bar{\sigma}$ to elements of $\bar{\tau}$.

Note that the tuple types are a refinement of the embedding types. Also for $n > 2$ this refinement is strict, by the example given above with $\{\sigma 0, \sigma 1, \sigma 00\}$ and $\{\sigma, \sigma 1, \sigma 00\}$: no strong isomorphism from $\{\sigma 0, \sigma 1, \sigma 00\}^{cl}$ to $\{\sigma, \sigma 1, \sigma 00\}^{cl}$ can map elements of $\{\sigma 0, \sigma 1, \sigma 00\}$ to those of $\{\sigma, \sigma 1, \sigma 00\}$ as no string is a prefix of the other two in the former but one is in the latter.

DEFINITION 7.8. Let $t_{sTT} : \omega \rightarrow \omega$ be the function which to n associates the number of tuple types that can be generated by n distinct strings.

Just like a coloring on $[2^{<\omega}]^n$ can recognize the generated embedding types, it can recognize the corresponding tuple types: the embedding type together with the role played by each string generating it. And just like no embedding type can be avoided in a strong perfect tree, also no tuple type can be avoided in a strong perfect tree. It follows that if c is a coloring of $[2^{<\omega}]^n$ which associates to an element its corresponding tuple type, then any strong perfect subtree of T needs at least $t_{sTT}(n)$ colors. In the next section we show that this number is optimal.

We are now ready to formally state and prove the strong generalized CHM tree theorem.

THEOREM 7.9 (Strong generalized CHM tree theorem). *For every n , the principle $(\forall k)SCMHTT_{k, t_{sTT}(n)}^n$ is provable in ACA_0 , and RCA_0 proves that the principle $(\forall k)SCMHTT_{k, t_{sTT}(n)-1}^n$ is false.*

PROOF. We already saw that this principle is false when the maximal number of color is $t_{s\text{TT}}(n) - 1$, with as an example the coloring on $[2^{<\omega}]^n$ which on each element associates an integer representing its tuple type.

Let us now show that one can prove the statement within ACA_0 for $t_{s\text{TT}}(n)$ colors. Let $\mathbf{t}_1, \mathbf{t}_2, \dots, \mathbf{t}_{t_{s\text{TT}}(n)}$ be an enumeration of the tuple types of size n . Let c be any coloring on the elements of $[2^{<\omega}]^n$.

Let $T_0 = 2^{<\omega}$ and inductively for $i < t_{s\text{TT}}(n)$, let \mathbf{e}_i be the embedding type that \mathbf{t}_i belongs to. Let m_i be the height of the canonical representative of \mathbf{t}_i . Let c_i be the color on T_i which on any strong subtree F of height m_i associates the color c gives on the unique element of $[F]^n$ with tuple type \mathbf{t}_i . Using corollary 4.7 stating that Milliken theorem for height m_i is provable in ACA_0 , let then T_{i+1} be a strong perfect subtree of T_i which belongs to Mc and which is monochromatic for c_i and let k_i be the corresponding color. For this step, note that even if Milliken theorem is stated for strong subtrees of $2^{<\omega}$, we can also apply it for strong subtrees of T where T is itself a strong subtree of $2^{<\omega}$.

Let $S = T_{t_{s\text{TT}}(n)}$. By induction we have that S is a strong subtree of $2^{<\omega}$. Any $\bar{\sigma} \in [S]^n$ belongs to some tuple type \mathbf{t}_i and thus has color k_i . Thus at most $t_{s\text{TT}}(n)$ color are used in S . \square

7.3. Avoiding types

We now turn to the study of CMHTT_k^n . In particular, we do not require our subtrees to be strings anymore. As expected we need fewer colors, basically because we can avoid some embedding types, and within the embedding types which cannot be avoided, we can avoid some tuple types.

Note that one can easily create a perfect tree which avoids almost all embedding types. Suppose we force for instance every node to be of different length. Formally such a tree has only embedding types which consists of comparable nodes, because any embedding type with two incomparable nodes contains two distinct nodes of the same length. However, this does not help: what we want is to avoid the embedding types (resp. the tuple types) which can be generated by the n -tuples of the tree, even though elements in the strong closure of the n -tuple are not necessarily all in the tree.

We will show given any strong tree S how to compute a perfect subtree T of S which avoids as many tuple types as possible. We in fact give right away the syntactic property a tree must have to avoid as many tuple types as possible.

DEFINITION 7.10. We say that a perfect tree T *syntactically minimizes the number of tuple types* if:

- (1) any two nodes of T^\wedge is of different length;
- (2) for any nodes $\sigma, \tau \in T$ with $\sigma \prec \tau$ we have $\sigma 0 \preceq \tau$;
- (3) for any nodes $\sigma, \tau \in T^{cl}$ with $\sigma \notin T^\wedge$ and $\sigma \prec \tau$ we have $\sigma 0 \preceq \tau$.

Given (1), note that (3) in the previous definition is equivalent to have for any incomparable nodes $\sigma, \tau \in T^\wedge$ with $|\sigma| < |\tau|$ that $\tau(|\sigma|) = 0$.

LEMMA 7.11. *Given any strong perfect subtree $S \subseteq 2^{<\omega}$, there is an S -computable perfect subtree $T \subseteq S$ which syntactically minimizes the number of tuple types.*

PROOF. Without loss of generality we consider that we work with $S = 2^{<\omega}$. The subtree that we build can then be pulled back in S using some isomorphism between $2^{<\omega}$ and S .

We start by computing a meet-closed subtree $T' \subseteq 2^\omega$ such that (1) and (3) are satisfied. We put in T_0 the root of $2^{<\omega}$. Then inductively suppose we have a finite perfect tree T_n such that each of its leaf is of level n and such that for $\tau_1, \tau_2 \in T_n$ we have $|\tau_1| + 1 < |\tau_2|$ or $|\tau_2| + 1 < |\tau_1|$. Let $\sigma_1, \dots, \sigma_k$ be the leaves of T_n such that $|\sigma_i| + 1 < |\sigma_{i+1}|$. We define $T_{n+1,0}$ to be T_n . Inductively for $i \leq k$ suppose we have defined a perfect tree $T_{n+1,i} \supseteq T_{n+1,0}$ such that for $\tau_1, \tau_2 \in T_{n+1,i}$ we have $|\tau_1| + 1 < |\tau_2|$ or $|\tau_2| + 1 < |\tau_1|$ and such that $|\sigma_i|$ is the smallest among the leaves of $T_{n+1,i}$. We let τ_0 be the lexicographically smallest such that:

- $|\sigma_{i+1}0\tau_0| - 1$ is bigger than every string in $T_{n+1,i}$;
- for every $\sigma \in T_{n+1,i}$ different from σ_{i+1} we have $\sigma_{i+1}0\tau_0(|\sigma|) = 0$.
Note that by the induction hypothesis we can find such a string.

Then let τ_1 be the lexicographically smallest such that:

- $|\sigma_{i+1}1\tau_1| - 1$ is bigger than every string in $T_{n+1,i} \cup \{\tau_0\}$;
- for every string $\sigma \in T_{n+1,i} \cup \{\tau_0\}$ different from σ_{i+1} we have $\sigma_{i+1}1\tau_1(|\sigma|) = 0$. Note that by the induction hypothesis we can find such a string.

Let us then define $T_{n+1,i+1} = T_{n+1,i} \cup \{\tau_0, \tau_1\}$. Note that σ_{i+1} becomes the smallest leaf of $T_{n+1,i+1}$. Once we have defined $T_{n+1,i}$ for every $i \leq k$ we define $T_{n+1} = T_{n+1,k}$.

We finally define $T' = \bigcup_n T_n$. By construction T' has the desired properties. Note that for any perfect subtree $T \subseteq T'$ then also every node is of different length, so (1) is preserved. Furthermore as T' is meet closed then also for any perfect tree $T \subseteq T'$ and any two incomparable nodes $\sigma, \tau \in T^\wedge$ with $|\sigma| < |\tau|$ we have $\tau(|\sigma|) = 0$, so (3) is preserved.

We finally find a perfect subtree $T \subseteq T'$ such that for any $\sigma, \tau \in T$ with $\sigma \prec \tau$ we have $\sigma 0 \preceq \tau$. Given an isomorphism $f : 2^{<\omega} \rightarrow T'$ we define T to be the range of f on strings of the form $\sigma 00$ or $\sigma 01$ for $\sigma \in 2^{<\omega}$. One can easily verify that T is a perfect subtree of T' on which (1) (2) and (3) are verified. \square

See Figure 7.6 for an illustration.

We shall see that the number above is optimal. Of course, it is not the case that one of the above types can never be omitted in a perfect tree and it is in fact one difficulty in showing that a tree T syntactically minimizing the number of tuple types really does so: every tuple type can be omitted in some perfect tree. Of course omitting a type may force some other type to become unavoidable. In order to overcome this difficulty, we need to

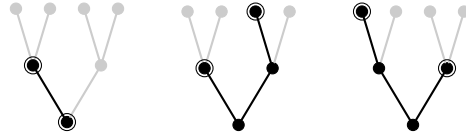

FIGURE 7.6. An example of three tuple types on $[T]^2$, for a tree T that syntactically minimizes the number of types.

introduce a third equivalence relation, within which we erase the part of a tuple type which can be omitted.

DEFINITION 7.12. The *weak tuple types* are the equivalence classes of the following relation: $\bar{\sigma}, \bar{\tau}$ have the same weak tuple type if there is a bijection f from $\bar{\sigma}^{cl}$ to $\bar{\tau}^{cl}$ such that:

- for $\sigma_1, \sigma_2 \in \bar{\sigma}^{cl}$ we have $\sigma_1 \preceq \sigma_2$ iff $f(\sigma_1) \preceq f(\sigma_2)$;
- for $\sigma_1, \sigma_2, \sigma_3 \in \bar{\sigma}^{cl}$ we have $\sigma_1 0 \preceq \sigma_2$ and $\sigma_1 1 \preceq \sigma_3$ iff $f(\sigma_1) 0 \preceq f(\sigma_2)$ and $f(\sigma_1) 1 \preceq f(\sigma_3)$;
- elements of $\bar{\sigma}$ are sent to $\bar{\tau}$.

In other word, weak tuple types are tuple types, modulo the fact that whenever a node is not branching, it does not matter for its extension to go left or right. It is clear from the definition that the tuple types are a refinement of the weak tuple types. But the weak tuple types are not a refinement of the embedding types, nor are the embedding types a refinement of the weak tuple types.

LEMMA 7.13. *Let T be a perfect tree which syntactically minimizes the number of tuple types. Then its tuple types and weak tuple types coincide.*

PROOF. We already have that the tuple types are a refinement of the weak tuple types. All we have to do is to show that restricted to T , the weak tuple types are a refinement of the tuple types.

For any n consider any two n -tuples $\bar{\sigma}, \bar{\tau}$ of T . Suppose they are in the same weak tuple type via some bijection $f : \bar{\sigma}^{cl} \rightarrow \bar{\tau}^{cl}$. Let us show that f in fact witnesses that $\bar{\sigma}$ and $\bar{\tau}$ are in the same tuple types. For that it is enough to show that $\sigma_1 i \preceq \sigma_2$ implies $f(\sigma_1) i \preceq f(\sigma_2)$ for $\sigma_1, \sigma_2 \in \bar{\sigma}^{cl}$. Let $\sigma_1, \sigma_2 \in \bar{\sigma}^{cl}$ with $\sigma_1 i \preceq \sigma_2$.

Suppose first that we have a string $\sigma_3 \in \bar{\sigma}^{cl}$ such that $\sigma_1(1-i) \preceq \sigma_3$. Then by definition of a weak tuple type we have $f(\sigma_1) i \preceq f(\sigma_2)$. Otherwise there are two possibilities: either $\sigma_1 \in \bar{\sigma}$ or $\sigma_1 \in \bar{\sigma}^{cl}$ but $\sigma_1 \notin \bar{\sigma}^\wedge$.

In the first case, note that we must have a string $\sigma_3 \in \bar{\sigma}$ with $\sigma_1 i \preceq \sigma_2 \preceq \sigma_3$. Note that as $\sigma_1, \sigma_3 \in \bar{\sigma}$ then also $\sigma_1, \sigma_3 \in T$. Then by property (2) in Definition 7.10 (the definition of syntactically minimizing the number of tuple type), we have $\sigma_1 0 \preceq \sigma_2 \preceq \sigma_3$. Note also that $f(\sigma_1) \preceq f(\sigma_1) \preceq f(\sigma_3)$ and that by hypothesis on f we have $f(\sigma_1), f(\sigma_3) \in \bar{\tau} \subseteq T$. Therefore also we have $f(\sigma_1) 0 \prec f(\sigma_3)$ by (2) in Definition 7.10 and thus we have $f(\sigma_1) 0 \prec f(\sigma_2)$.

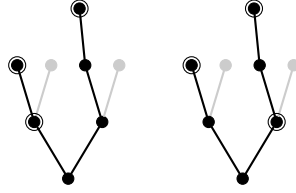

FIGURE 7.7. An example of two length-injective and meet-avoiding tuple types, generating the same embedding type.

In the second case we have $\sigma_1, \sigma_2 \in T^{cl}$ and $\sigma_1 \notin T^\wedge$. Thus by property (3) in Definition 7.10 we have $\sigma_1 0 \preceq \sigma_2$. We shall argue that also $f(\sigma_1) \notin T^\wedge$. Suppose for contradiction that $f(\sigma_1) \in T^\wedge$. Then also $f(\sigma_1) \in \bar{\tau}^\wedge$. Recall that by hypothesis $\sigma_1 \notin \bar{\sigma}$ and thus $f(\sigma_1) \notin \bar{\tau}$ (as f is a bijection between the two). It follows that $f(\sigma_1)$ must be the meet of two nodes in $\bar{\tau}$ and thus is branching in $\bar{\tau}^{cl}$. On the other hand as $\sigma_1 \notin T^\wedge$ it is not branching in $\bar{\sigma}^{cl}$ which contradicts the properties of f . Thus $f(\sigma_1) \notin T^\wedge$ and it follows by property (3) in the definition of syntactically minimizes the number of tuple type that $f(\sigma_1) 0 \preceq f(\sigma_2)$.

We then have that $\bar{\sigma}$ and $\bar{\tau}$ are in the same tuple types. \square

We shall now identify the weak tuple types no perfect tree can omit. We shall then see that weak tuple types of a tree which syntactically minimizes the number of tuple types are all of this form. It will then follow that such a tree really minimizes the number of tuple types.

DEFINITION 7.14. A tuple type (resp. a weak tuple type) $\bar{\sigma}$ is *length-injective* if $\sigma_1, \sigma_2 \in \bar{\sigma}^\wedge$ implies $|\sigma_1| \neq |\sigma_2|$.

DEFINITION 7.15. A tuple type (resp. a weak tuple type) $\bar{\sigma}$ is *meet-avoiding* if for any incomparable $\sigma_1, \sigma_2 \in \bar{\sigma}$ we have $\sigma_1 \wedge \sigma_2 \notin \bar{\sigma}$.

See Figure 7.7 for an illustration.

Up to symmetry and restricted to a tree which syntactically minimizes the number of types, these are the only tuple types generated by three strings and which are in the same embedding type. We will now see that the length-injective and meet-avoiding weak tuple types are exactly those which cannot be avoided by a perfect tree.

LEMMA 7.16. *Let S be any perfect tree. Then S has a member inside every length-injective and meet-avoiding weak tuple type.*

PROOF. Let $\bar{\sigma}$ be a length-injective and meet-avoiding tuple type. Let us define first an injection f from $\bar{\sigma}^\wedge$ into S^\wedge with the following properties:

- (1) $f(\bar{\sigma}) \subseteq S$;
- (2) for $\sigma_1, \sigma_2 \in \bar{\sigma}^\wedge$ we have $\sigma_1 \preceq \sigma_2$ iff $f(\sigma_1) \preceq f(\sigma_2)$;
- (3) if σ_1 is branching in $\bar{\sigma}^\wedge$ then $f(\sigma_1)$ is branching in S^\wedge . Furthermore for $\sigma_1, \sigma_2, \sigma_3 \in \bar{\sigma}^\wedge$ we have $\sigma_1 0 \preceq \sigma_2$ and $\sigma_1 1 \preceq \sigma_3$ iff $f(\sigma_1) 0 \preceq f(\sigma_2)$ and $f(\sigma_1) 1 \preceq f(\sigma_3)$;

(4) for $\sigma_1, \sigma_2 \in \bar{\sigma}^\wedge$ we have $|\sigma_1| < |\sigma_2|$ iff $|f(\sigma_1)| < |f(\sigma_2)|$.

Let $\sigma_1, \dots, \sigma_n$ be a list of the elements of $\bar{\sigma}^\wedge$ with $|\sigma_1| < |\sigma_2| < \dots < |\sigma_n|$. Note that we must have $\sigma_i \preceq \sigma_j$ implies $i \leq j$. Note also that as $\bar{\sigma}$ is meet-avoiding we must have that $\rho \in \bar{\sigma}^\wedge$ is branching in $\bar{\sigma}^\wedge$ iff $\rho \notin \bar{\sigma}$.

If $\sigma_1 \in \bar{\sigma}$ then find the lexicographically first $\tau \in S$ and let $f(\sigma_1) = \tau$. Otherwise find the lexicographically first $\tau \in S^\wedge$ which is branching in S^\wedge and let $f(\sigma_1) = \tau$. Note that so far (1)(2)(3) and (4) are satisfied.

Suppose $f(\sigma_1), \dots, f(\sigma_k)$ have been defined with (1)(2)(3) and (4) satisfied so far. Consider σ_{k+1} . Let $j \leq k$ be the largest such that $\sigma_j \prec \sigma_{k+1}$. Suppose first σ_j is branching in $\bar{\sigma}^\wedge$. Then by induction hypothesis (3) we must have that $f(\sigma_j)$ is branching in S^\wedge . In this case let $i \in \{0, 1\}$ be such that $\sigma_j i \preceq \sigma_{k+1}$. If $\sigma_{k+1} \in \bar{\sigma}$ then find the lexicographically first $\tau \in S$ such that $|\tau| > |f(\sigma_k)|$ and such that $f(\sigma_j)i \preceq \tau$. Then let $f(\sigma_{k+1}) = \tau$. Otherwise find the lexicographically first branching $\tau \in S^\wedge$, such that $|\tau| > |f(\sigma_k)|$ and such that $f(\sigma_j)i \preceq \tau$. Then let $f(\sigma_{k+1}) = \tau$. Note that in any case (1) (2) (3) and (4) are satisfied so far.

Suppose now σ_j is not branching in $\bar{\sigma}^\wedge$. If $\sigma_{k+1} \in \bar{\sigma}$ then find the lexicographically first $\tau \in S$ such that $|\tau| > |f(\sigma_k)|$ and such that $f(\sigma_j) \preceq \tau$. Then let $f(\sigma_{k+1}) = \tau$. Otherwise find the lexicographically first branching $\tau \in S^\wedge$, such that $|\tau| > |f(\sigma_k)|$ and such that $f(\sigma_j) \preceq \tau$. Then let $f(\sigma_{k+1}) = \tau$. Note that in any case (1) (2) (3) and (4) are satisfied so far. This ends the first part of the construction.

Note also that f is a bijection between $\bar{\sigma}$ and $f(\bar{\sigma}) \subseteq S$. In order to show that $\bar{\sigma}$ and $f(\bar{\sigma})$ are in the same weak tuple type, we shall now extend f to $\bar{\sigma}^{cl}$ such that f becomes a bijection from $\bar{\sigma}^{cl}$ to $f(\bar{\sigma})^{cl}$.

Let us first argue that so far f is a bijection from $\bar{\sigma}^\wedge$ to $f(\bar{\sigma})^\wedge$. We have $f(\bar{\sigma}) \subseteq f(\bar{\sigma}^\wedge)$. By design we also have that $f(\bar{\sigma}^\wedge)$ is meet closed and thus we have $f(\bar{\sigma})^\wedge = f(\bar{\sigma}^\wedge)$. As f is injective it is a bijection from $\bar{\sigma}^\wedge$ to $f(\bar{\sigma})^\wedge$ and then it is a bijection from $\bar{\sigma}^\wedge$ to $f(\bar{\sigma})^\wedge$.

Let us now extend f to $\bar{\sigma}^{cl}$: for incomparable $\sigma_1, \sigma_2 \in \bar{\sigma}^\wedge$ with $|\sigma_1| < |\sigma_2|$ we assign $f(\sigma_2 \upharpoonright |\sigma_1|)$ to $f(\sigma_2) \upharpoonright |f(\sigma_1)|$. Let us now show that $f(\bar{\sigma}^{cl}) = f(\bar{\sigma})^{cl}$. It is clear by definition of f that $f(\bar{\sigma}^{cl}) \subseteq f(\bar{\sigma})^{cl}$. Let us now show $f(\bar{\sigma})^{cl} \subseteq f(\bar{\sigma}^{cl})$.

Suppose $\tau \in f(\bar{\sigma})^{cl}$. Then as $f(\bar{\sigma})^{cl} = (f(\bar{\sigma})^\wedge)^{cl} = f(\bar{\sigma}^\wedge)^{cl}$ we have $\tau \in f(\bar{\sigma}^\wedge)^{cl}$. Then there exists $\sigma_1, \sigma_2 \in \bar{\sigma}^\wedge$ with $|f(\sigma_1)| < |f(\sigma_2)|$ and with $\tau = f(\sigma_2) \upharpoonright |f(\sigma_1)|$. By (4) we have $|\sigma_1| < |\sigma_2|$ and then $\sigma_2 \upharpoonright |\sigma_1| \in \bar{\sigma}^{cl}$. Thus $\tau \in f(\bar{\sigma}^{cl})$ and then $f(\bar{\sigma})^{cl} \subseteq f(\bar{\sigma}^{cl})$ and then $f(\bar{\sigma})^{cl} = f(\bar{\sigma}^{cl})$.

Let us now show that f is injective on $\bar{\sigma}^{cl}$. Let $\sigma_1, \sigma_2, \rho_1, \rho_2 \in \bar{\sigma}^\wedge$ with σ_1, σ_2 and ρ_1, ρ_2 incomparable, with $|\sigma_1| < |\sigma_2|$ and with $|\rho_1| < |\rho_2|$. Suppose $\sigma_2 \upharpoonright |\sigma_1| \neq \rho_2 \upharpoonright |\rho_1|$. If $\sigma_1 \neq \rho_1$ then by (4) we must have $|f(\sigma_1)| \neq |f(\rho_1)|$ and thus $f(\sigma_2) \upharpoonright |f(\sigma_1)| \neq f(\rho_2) \upharpoonright |f(\rho_1)|$. Otherwise it must be that $\sigma_2 \upharpoonright s \neq \rho_2 \upharpoonright s$ for $s = |\sigma_1| = |\rho_1|$. By definition of f it must be that $f((\sigma_2 \upharpoonright s) \wedge (\rho_2 \upharpoonright s)) = f(\sigma_2 \upharpoonright s) \wedge f(\rho_2 \upharpoonright s)$ and thus by (3) that $f(\sigma_2 \upharpoonright s) \neq f(\rho_2 \upharpoonright s)$.

It follows that f is a bijection from $\bar{\sigma}^{cl}$ to $f(\bar{\sigma}^{cl})$ and thus that it is a bijection from $\bar{\sigma}^{cl}$ to $f(\bar{\sigma})^{cl}$.

It is clear that property (1) and (2) is still satisfied by f on $\bar{\sigma}^{cl}$. Also as every branching node of $\bar{\sigma}^{cl}$ is already branching in $\bar{\sigma}^\wedge$ property (3) is still satisfied on $\bar{\sigma}^{cl}$. It follows that $\bar{\sigma}$ and $f(\bar{\sigma})$ are in the same weak tuple type. \square

LEMMA 7.17. *Let T be a tree which syntactically minimizes the number of tuple types. Then every weak tuple type of T is length-injective and meet-avoiding.*

PROOF. By definition we have that $\sigma_1, \sigma_2 \in T^\wedge$ implies $|\sigma_1| \neq |\sigma_2|$. Thus the weak tuple types of T are length-injective. Suppose now $\sigma_1, \sigma_2 \in T$ with σ_1, σ_2 incomparable. Suppose for contradiction that $\sigma_1 \wedge \sigma_2 \in T$. Then we have $(\sigma_1 \wedge \sigma_2)1 \preceq \sigma_1$ or $(\sigma_1 \wedge \sigma_2)1 \preceq \sigma_2$. In any case we violate property (2) of syntactically minimizing the number of types. Thus for any $\sigma_1, \sigma_2 \in T$ with σ_1, σ_2 incomparable we have $\sigma_1 \wedge \sigma_2 \notin T$ which implies that the weak tuple types of T are meet-avoiding. \square

7.4. Generalized CHM tree theorem

We are now ready to study the generalized CHM tree theorem, where we do not necessarily required the subtree to be a strong subtree.

DEFINITION 7.18. Given a perfect tree T , let $t_{TT}^T(n)$ be the number of tuple types generated by n distinct strings of T . Let

$$t_{TT}(n) = \min\{t_{TT}^T(n) \mid T \text{ is a perfect tree}\}.$$

THEOREM 7.19. *Suppose T syntactically minimizes the number of tuple types, then $t_{TT}(n) = t_{TT}^T(n)$.*

PROOF. Suppose T syntactically minimizes the number of tuple types. Then by Lemma 7.13 the tuple types of T coincide with its weak tuple types. By Lemma 7.17 every weak tuple type of T is length-injective and meet-avoiding. By Lemma 7.16 we then have that every weak-tuple type of T is a weak-tuple type in any perfect tree S . Using the fact that the tuple types are a refinement of the weak tuple types, we then have that given any n , the number of tuple types of $[S]^n$ is bigger than the number of weak tuple types of $[S]^n$ and then bigger than the number of weak tuple types of $[T]^n$ and then bigger than the number of tuple types of $[T]^n$. Thus $t_{TT}(n) = t_{TT}^T(n)$. \square

THEOREM 7.20 (Generalized CHM tree theorem). *For every n , the principle $\text{CMHTT}_{k, t_{TT}(n)}^n$ is provable in ACA_0 but RCA_0 proves that the principle $\text{CMHTT}_{k, t_{TT}(n)-1}^n$ is false.*

PROOF. Let Mc be a model of ACA_0 . Let $T \in Mc$ be a perfect tree and $c \in Mc$ be a color of $[T]^n$. Using Theorem 7.9, there is a strong subtree $S \subseteq T$ such that every tuple type of $[S]^n$ is monochromatic for

c. Using Lemma 7.11 let R be a S -computable perfect subtree of S which syntactically minimizes the number of tuple types. Note that $R \in Mc$ and that by Theorem 7.19 $[R]^n$ has at most $t_{\text{TT}}(n)$ many tuple types. It follows that c uses at most $t_{\text{TT}}(n)$ many colors on R .

To show optimality, and given an enumeration $\{\epsilon_i\}_{i \leq t_{\text{sTT}}(n)}$ of the tuple types generated by n strings, let us define a color on $2^{<\omega}$ which associates i to $\bar{\sigma}$ of tuple type ϵ_i . By minimality of $t_{\text{TT}}(n)$ among $t_{\text{TT}}^T(n)$ for a perfect tree T we have that every perfect subtree of $2^{<\omega}$ uses at least $t_{\text{TT}}(n)$ colors. \square

THEOREM 7.21 (CHM tree theorem for n -tuple and k -colors). *For every coloring of n -tuples of pairwise comparable strings, there exists a perfect tree on which the coloring is monochromatic.*

PROOF. This follows from the fact that given any n , there is only one weak tuple type of size n which contains only comparable strings. \square

It is easy to determine the number e_n of embedding types of height n , which is given by the following induction:

$$\begin{aligned} e_0 &= 1, \\ e_1 &= 1, \\ e_{n+1} &= 2 \times e_n \times \left(\sum_{i < n} e_i\right) + e_n^2. \end{aligned}$$

The definition above is justified by the following observation: there is one tree of height 0 (the emptyset), there is one tree of height 1 (the empty string) and for any $n \geq 1$, the possibilities to build trees of height $n + 1$ are as follow: having a left subtree of the root (the empty string) of height n and a right subtree of the root of height $< n$, or the inverse of that, or have both a left and a right subtree of the root of height n .

The number of embedding types generated by n strings, namely $e_{\text{sTT}}(n)$ appears much harder to compute. It is the same for $t_{\text{sTT}}(n)$ and $t_{\text{TT}}(n)$. We can also define the function $n \mapsto e_{\text{TT}}(n)$ which to n associates the minimal number of embedding type within any perfect tree (which is the number of embedding types generated by n strings of a tree which syntactically minimizes the number of tuple types).

We computed the first values of each with the help of a computer program:

| | e_{sTT} | t_{sTT} | e_{TT} | t_{TT} |
|---|------------------|------------------|-----------------|-----------------|
| 0 | 1 | 1 | 1 | 1 |
| 1 | 1 | 1 | 1 | 1 |
| 2 | 7 | 7 | 3 | 3 |
| 3 | 345 | 369 | 27 | 29 |
| 4 | 136949 | 145215 | 561 | 635 |

None of these sequence appears in OEIS, The On-Line Encyclopedia of Integer Sequences [22]. It then seems that each of them is a new natural combinatorial sequence. Even if it seems that these sequences cannot be

computed with an easy mathematical induction like for the number of embedding types of height n , we conjecture each of them to be polynomial time computable.

CHAPTER 8

Open Questions

The computability-theoretic study of Milliken’s tree theorem and its applications being completely new, this work leaves many questions open. We collect some here that seem most promising for follow-up research directions.

8.1. Milliken’s tree theorem in the arithmetical hierarchy

When analyzing a mathematical problem from a computability-theoretic viewpoint, the first step usually consists in determining whether the computable instances of the problem admit arithmetical solutions, and if so, trying to identify the exact level in the arithmetical hierarchy where they stand. For example, Jockusch [23] proved that every computable instance of Ramsey’s theorem for n -tuples admits Π_n^0 solutions, and for each $n \geq 2$, constructed a computable instance of Ramsey’s theorem for n -tuples and 2 colors with no Σ_n^0 solutions. Thus, the status of Ramsey’s theorem with respect to the arithmetical hierarchy is fully determined.

The case of Milliken’s tree theorem is less clear. By Theorem 4.6, computable instances of Milliken’s tree theorem admit arithmetical solutions. More precisely, every computable instance of Milliken’s tree theorem for subtrees of height n admits a Δ_{2n-1}^0 solution. On the other hand, since Milliken’s tree theorem generalizes Ramsey’s theorem, for every $n \geq 2$, there exists a computable instance of Milliken’s tree theorem for trees of height n with no Σ_n^0 solutions. This leaves a gap between the lower and upper bound.

QUESTION 1. Does every computable instance of Milliken’s tree theorem for height n admit a Δ_{n+1}^0 solution?

The proof by Jockusch [23] of the existence of a Π_2^0 solution for every computable instance of Ramsey’s theorem for n -tuples is by an inductive argument based on the notion of prehomogeneous set. In particular, he proves that every PA degree relative to \emptyset' is sufficient to compute a prehomogeneous set. Hirschfeldt and Jockusch [21, Theorem 2.1] actually proved a reversal, by constructing a computable instance of Ramsey’s theorem for triples such that every prehomogeneous set is of PA degree relative to \emptyset' . This bound on prehomogeneous sets is sufficient to make increasing the level in the arithmetical hierarchy only by one when increasing the size of the colored tuples by one, by taking prehomogeneous sets of low degree over \emptyset' .

Similarly, the current upper bound of Milliken’s tree theorem is proved using the corresponding notion of prehomogeneous tree, but Lemma 4.5

yields only a Δ_3^0 solution, which makes increase the level in the arithmetical hierarchy by 2 instead of 1 when coloring larger tuples. The following questions are still open:

QUESTION 2. Given a computable instance of the Milliken's tree theorem for height n , does any PA degree relative to \emptyset' compute a prehomogeneous infinite strong subtree? Is there always a prehomogeneous infinite strong subtree of low degree relative to \emptyset' ?

A positive answer to either question would be sufficient to answer positively Question 1.

8.2. Larger degrees and cone avoidance

Cone avoidance is a central notion in the computability-theoretic analysis of theorems. It is the main tool for separating a theorem from ACA_0 over ω -structures. It is in particular a desirable property to have, and given a statement which does not admit cone avoidance, one can ask whether there exists a natural weakening of it which admits it. The analysis of Ramsey's theorem gives a good example: Jockusch [23] constructed for every $n \geq 3$ a computable instance of Ramsey's theorem for n -tuples whose solutions compute the halting set. In particular, this shows that Ramsey's theorem for 3-tuples does not admit cone avoidance. On the other hand, Wang [49, Theorem 3.2] proved that when weakening the notion of homogeneity in Ramsey's theorem by allowing a larger number of colors, then the resulting statement admits cone avoidance. In particular, he proved that $(\forall k)\text{RT}_{k,2}^3$ admits cone avoidance, where $(\forall k)\text{RT}_{k,\ell}^n$ is the statement whose instances are colorings $f : [\omega]^n \rightarrow k$ for some k , and whose solutions are infinite sets H such that $|f[H]| \leq \ell$. In general, Wang proved that for every n , and every ℓ sufficiently large with respect to n , the statement $(\forall k)\text{RT}_{k,\ell}^n$ admits cone avoidance. Cholak and Patey [4] computed the exact bound where this threshold phenomenon happens, which happens to be $(\forall k)\text{RT}_{k,C_{n-1}}^n$, where C_0, C_1, \dots is the Catalan sequence, starting with 1, 1, 2, 5, 14, 42, \dots

Milliken's tree theorem behaves like Ramsey's theorem with many respects. Milliken's tree theorem for pairs admits cone avoidance, while there exists a computable instance of Milliken's tree theorem for trees of height 3 whose solutions compute the halting set. By a similar investigation, we proved in Section 4.4 that $(\forall k)\text{PMTT}_{k,2}^3$ admits cone avoidance (Theorem 4.28), where $(\forall k)\text{PMTT}_{k,\ell}^n$ is the weakening of $(\forall k)\text{PMTT}^n$ where ℓ colors are allowed in the solutions.

The proof of Theorem 4.28 goes through the existence of a level-homogeneous strong subtree. Recall that a tree T is level-homogeneous with respect to a coloring $f : \mathcal{S}_n(T)$ if strong subtrees with the same level function get assigned the same color. This notion reduces the problem of finding an infinite strong subtree monochromatic for f to the problem of finding an infinite homogeneous set. Indeed, if T is level-homogeneous with respect to f , the color depends only on the levels, hence becomes a coloring

of $[\omega]^n$. The known counter-examples to cone avoidance of Milliken's tree theorem for trees of height at least 3 as all inherited from Ramsey's theorem by defining a coloring which depends only on the levels. We proved that the statement which to a finite coloring of $\mathcal{S}_3(T)$, associates an infinite level-homogeneous strong subtree, admits cone avoidance. This result goes towards the intuition that the strength of Milliken's tree theorem is mainly inherited from Ramsey's theorem. It is therefore natural to wonder whether the statement of the existence of a level-homogeneous infinite strong subtree admits cone avoidance, when considering colorings of finite subtrees of larger height. Since the proof from height n to height $n + 1$ is usually inductive, by first proving cone avoidance for height n , then strong cone avoidance for height n , and then only cone avoidance for height $n + 1$, we wonder whether the statement of the existence of a level-homogeneous infinite strong subtree admits strong cone avoidance.

QUESTION 3. Given two sets C and Z such that $C \not\leq_T Z$, and a finite sequence of Z -computable, Z -computably bounded, infinite trees with no leaves T_0, \dots, T_{d-1} , does every coloring $f : \mathcal{S}_n(T_0, \dots, T_{d-1}) \rightarrow k$ admit a level-homogeneous tuple $(S_0, \dots, S_{d-1}) \in \mathcal{S}_\omega(T_0, \dots, T_{d-1})$ such that $C \not\leq_T Z \oplus S_0 \oplus \dots \oplus S_{d-1}$?

A positive answer to this question would enable to make it benefit from the computability-theoretic analysis for Ramsey's theorem, and in particular would imply that $(\forall k)\text{PMTT}_{k, C_{n-1}}^n$ admits cone avoidance.

8.3. Comparing the statements for pairs in reverse mathematics

Ramsey's theorem for pairs admits a special status with respect to full Ramsey's theorem in reverse mathematics, as it admits cone avoidance, while Ramsey's theorem for larger tuples is equivalent to ACA_0 over RCA_0 . This threshold phenomenon was also satisfied by the Chubb-Hirst-McNicholl tree theorem (see Dzhafarov and Patey [15]) whose statement for pairs admits cone avoidance, while is equivalent to ACA_0 for larger tuples, or the Erdős-Rado theorem (see Chong, Liu, Liu and Yang [5]). We therefore naturally had a particular focus on the restriction of Milliken's tree theorem for trees of height 2, and on the applications of Milliken's tree theorem restricted to pairs.

As we can see in the proof of Devlin's theorem and the Rado graph theorem using Milliken's tree theorem, both Devlin's theorem for n -tuples and the Rado graph theorem for graphs of size n involve applications of Milliken's tree theorem for strong subtrees of height $2n - 1$. This is essentially due to Lemma 5.21. Informally, when representing rational numbers as strings, any coloring of a pairs of rationals induces a coloring of strong subtrees of height 3, by considering the tree whose first level is the length of their meet, the second level is the length of the shortest of the two strings representing the rationals, and the third level is the longest length.

This yields two main questions, namely, (1) whether there exists another proof of these statements of size n involving only applications of Milliken's tree theorem for trees of height n , and (2) whether these statements should be more considered as statement about pairs or about triples. The latter question is more informal, and depends on the aspects considered.

One aspect separating Ramsey's theorem for pairs from larger tuples is the existence of cone avoiding solutions. With this respect, Devlin's theorem admits a computable instance whose solutions all compute the halting set, while the Rado graph theorem for graphs of size 2, the Erdős-Rado theorem and Milliken's tree theorem for pairs are all cone avoiding. This proves in particular that Milliken's tree theorem for pairs does not imply Devlin's theorem for pairs in RCA_0 , and answers the first question negatively for Devlin's theorem. Another aspect which could better capture the difference between statements about pairs and about larger tuples, is the position in the arithmetical hierarchy. As explained, Jockusch [23] proved the existence of a computable instance of Ramsey's theorem for triples with no Σ_3^0 solution, while every computable instance of Ramsey's theorem for pairs admits a Π_2^0 solution. Here again, using this criterium, Devlin's theorem for pairs does not seem to be a statement about pairs. Indeed, by Corollary 5.41 in a computable instance of Devlin's theorem for pairs with no Σ_3^0 solution. The question for the Rado graph theorem for graphs of height 2 and for the Erdős-Rado theorem remains open:

QUESTION 4. Is there a computable instance of the Rado graph theorem for graphs of size 2 with no Σ_3^0 solution? Same question for the Erdős-Rado theorem for pairs.

If the answer is yes, then this would answer negatively the corresponding part of the following question.

QUESTION 5. Does MTT^2 imply $(\forall k)\text{RG}_{k,4}^2$ over RCA_0 ? Same question for ER^2 .

Milliken's tree theorem for trees of height 2 is a natural generalization of Ramsey's theorem for pairs, and so is the Erdős-Rado theorem. By Theorem 5.32, this is also the case of Devlin's theorem for pairs. It is however unknown whether the Rado graph theorem for graphs of height 2 also implies Ramsey's theorem for pairs. On the positive side, the Rado graph theorem for pairs implies a stable version of Ramsey's theorem for pairs (see Theorem 6.55). Thus, by the decomposition of Ramsey's theorem for pairs in its stable version and the cohesiveness principle (see Cholak, Jockusch and Slaman [3], Section 7), the question can be rephrased as whether the Rado graph theorem for pairs implies the COH over RCA_0 .

QUESTION 6. Does $(\forall k)\text{RG}_{k,4}^2$ imply RT_2^2 over RCA_0 ? Equivalently, does $(\forall k)\text{RG}_{k,4}^2$ imply COH over RCA_0 ?

Devlin's theorem for pairs and the Erdős-Rado theorem are both statements about colorings of pairs of rationals. The former is symmetric, in

that the nature of the solution does not depend on value of the color, and is thus arguably more natural than the Erdős-Rado theorem. Since the statement $\text{DT}_{<\infty,2}^2$ is somehow combinatorially optimal with respect to coloring of pairs of dense linear orders with no endpoints, one could expect that it implies the Erdős-Rado theorem. This is actually the case by Theorem 5.48: $\text{DT}_{4,2}^2$ implies ER^2 over RCA_0 . On the other hand, ER^2 admits cone avoidance, while $\text{DT}_{4,2}^2$ does not. This yields the following question: is there a natural statement which implies ER^2 and does admit cone avoidance? The notion of naturality is kept informal. When increasing the number of colors allowed in the solutions of Devlin's theorem for pairs, the statement $\text{DT}_{<\infty,4}^2$ is the first one admitting cone avoidance (Corollary 5.44). This yields the following question:

QUESTION 7. Does $\text{DT}_{<\infty,4}^2$ imply ER^2 over RCA_0 ?

Part of the reason we might expect this to be true is because in Section 5.5, we did actually prove cone avoidance of ER^2 (first shown by Chong, Liu, Liu and Yang [5]) using $\text{DT}_{<\infty,4}^2$. However, our proof involved the existence of a generic set for a particular notion of forcing, and this may not belong to a given model of RCA_0 . Thus, it does not settle the question, but it makes an affirmative answer plausible.

Bibliography

1. Vasco Brattka, Guido Gherardi, and Arno Pauly, *Weihrauch complexity in computable analysis*, (to appear).
2. Timothy J. Carlson and Stephen G. Simpson, *A dual form of Ramsey's theorem*, *Adv. in Math.* **53** (1984), no. 3, 265–290. MR 753869
3. Peter A. Cholak, Carl G. Jockusch, and Theodore A. Slaman, *On the strength of Ramsey's theorem for pairs*, *Journal of Symbolic Logic* **66** (2001), no. 01, 1–55.
4. Peter A. Cholak and Ludovic Patey, *Thin set theorems and cone avoidance*, *Transactions of the AMS*. To appear., 2019.
5. Chi Tat Chong, Wei Li, Lu Liu, and Yue Yang, *The strength of Ramsey's theorem for pairs over trees: Iv. erdos-rado's theorem for rationals*, 2019.
6. ———, *The strength of Ramsey's theorem for pairs over trees: Ii. chain-anti-chain and ascending descending sequence*, 2019.
7. ———, *The strength of Ramsey's theorem for pairs over trees: Iii. low2 construction*, 2019.
8. Jennifer Chubb, Jeffrey L. Hirst, and Timothy H. McNicholl, *Reverse mathematics, computability, and partitions of trees*, *Journal of Symbolic Logic* **74** (2009), no. 01, 201–215.
9. Denis Campau Devlin, *Some partition theorems and ultrafilters on Omega*, ProQuest LLC, Ann Arbor, MI, 1980, Thesis (Ph.D.)–Dartmouth College. MR 2628717
10. Natasha Dobrinen, *A list of problems on the reverse mathematics of Ramsey theory on the Rado graph and on infinite, finitely branching trees*, arXiv preprint <https://arxiv.org/pdf/1808.10227.pdf> (2018).
11. Natasha Dobrinen, Claude Laflamme, and Norbert Sauer, *Rainbow Ramsey simple structures*, *Discrete Math.* **339** (2016), no. 11, 2848–2855. MR 3518438
12. Rodney G. Downey and Denis R. Hirschfeldt, *Algorithmic randomness and complexity*, Springer, 2010.
13. Damir D. Dzhafarov, *Cohesive avoidance and strong reductions*, *Proceedings of the American Mathematical Society* **143** (2014), no. 2, 869–876.
14. Damir D. Dzhafarov and Carl G. Jockusch, *Ramsey's theorem and cone avoidance*, *Journal of Symbolic Logic* **74** (2009), no. 2, 557–578.
15. Damir D. Dzhafarov and Ludovic Patey, *Coloring trees in reverse mathematics*, *Adv. Math.* **318** (2017), 497–514. MR 3689748
16. Emanuele Frittaion and Ludovic Patey, *Coloring the rationals in reverse mathematics*, *Computability* **6** (2017), no. 4, 319–331. MR 3722986
17. Jun Le Goh, *Some computability-theoretic reductions between principles around atr_0* , (to appear).
18. Ronald L. Graham, Bruce L. Rothschild, and Joel H. Spencer, *Ramsey theory*, Wiley Series in Discrete Mathematics and Optimization, John Wiley & Sons, Inc., Hoboken, NJ, 2013, Paperback edition of the second (1990) edition [MR1044995]. MR 3288500
19. J. D. Halpern and H. Läuchli, *A partition theorem*, *Trans. Amer. Math. Soc.* **124** (1966), 360–367. MR 200172
20. Denis R. Hirschfeldt, *Slicing the truth*, Lecture Notes Series. Institute for Mathematical Sciences. National University of Singapore, vol. 28, World Scientific Publishing

- Co. Pte. Ltd., Hackensack, NJ, 2015, On the computable and reverse mathematics of combinatorial principles, Edited and with a foreword by Chitat Chong, Qi Feng, Theodore A. Slaman, W. Hugh Woodin and Yue Yang. MR 3244278
21. Denis R. Hirschfeldt and Carl G. Jockusch, *On notions of computability-theoretic reduction between Π_2^1 principles*, J. Math. Log. **16** (2016), no. 1, 1650002, 59. MR 3518779
 22. OEIS Foundation Inc., *The On-line Encyclopedia of Integer Sequences*, 2020.
 23. Carl G. Jockusch, *Ramsey's theorem and recursion theory*, Journal of Symbolic Logic **37** (1972), no. 2, 268–280.
 24. Carl G. Jockusch and Robert I. Soare, *Degrees of members of Π_1^0 classes*, Pacific Journal of Mathematics **40** (1972), 605–616.
 25. Carl G. Jockusch and Robert I. Soare, *Π_1^0 classes and degrees of theories*, Transactions of the American Mathematical Society **173** (1972), 33–56.
 26. Takayuki Kihara, Alberto Marcone Marcone, and Arno Pauly, *Searching for an analogue of atr in the weihrauch lattice*, J. Symb. Log. (to appear).
 27. C. Laflamme, N. W. Sauer, and V. Vuksanovic, *Canonical partitions of universal structures*, Combinatorica **26** (2006), no. 2, 183–205. MR 2223634
 28. Jean A. Larson, *Counting canonical partitions in the random graph*, Combinatorica **28** (2008), no. 6, 659–678. MR 2488745
 29. Joseph Roy Mileti, *Partition theorems and computability theory*, ProQuest LLC, Ann Arbor, MI, 2004, Thesis (Ph.D.)—University of Illinois at Urbana-Champaign. MR 2706695
 30. Keith R. Milliken, *A Ramsey theorem for trees*, J. Combin. Theory Ser. A **26** (1979), no. 3, 215–237. MR 535155
 31. ———, *A partition theorem for the infinite subtrees of a tree*, Trans. Amer. Math. Soc. **263** (1981), no. 1, 137–148. MR 590416
 32. Ludovic Patey, *The strength of the tree theorem for pairs in reverse mathematics*, J. Symb. Log. **81** (2016), no. 4, 1481–1499. MR 3579119
 33. David Pincus, *On the independence of the Kinna-Wagner principle*, Z. Math. Logik Grundlagen Math. **20** (1974), 503–516. MR 369066
 34. David Pincus and J. D. Halpern, *Partitions of products*, Trans. Amer. Math. Soc. **267** (1981), no. 2, 549–568. MR 626489
 35. F. P. Ramsey, *On a Problem of Formal Logic*, Proc. London Math. Soc. (2) **30** (1929), no. 4, 264–286. MR 1576401
 36. N. W. Sauer, *Coloring subgraphs of the Rado graph*, Combinatorica **26** (2006), no. 2, 231–253. MR 2223636
 37. David Seetapun and Theodore A. Slaman, *On the strength of Ramsey's theorem*, Notre Dame Journal of Formal Logic **36** (1995), no. 4, 570–582.
 38. Richard A. Shore, *Splitting an α -recursively enumerable set*, Trans. Amer. Math. Soc. **204** (1975), 65–77. MR 0379154 (52 #60)
 39. ———, *The Turing degrees: an introduction*, Forcing, iterated ultrapowers, and Turing degrees, Lect. Notes Ser. Inst. Math. Sci. Natl. Univ. Singap., vol. 29, World Sci. Publ., Hackensack, NJ, 2016, pp. 39–121. MR 3411034
 40. Stephen G Simpson, *Degrees of unsolvability: a survey of results*, Studies in Logic and the Foundations of Mathematics **90** (1977), 631–652.
 41. Stephen G. Simpson, *Subsystems of Second Order Arithmetic*, Cambridge University Press, 2009.
 42. Robert I. Soare, *Turing computability*, Theory and Applications of Computability, Springer-Verlag, Berlin, 2016, Theory and applications. MR 3496974
 43. E. Specker, *Ramsey's theorem does not hold in recursive set theory*, Logic Colloquium '69 (Proc. Summer School and Colloq., Manchester, 1969), North-Holland, Amsterdam, 1971, pp. 439–442. MR 0278941
 44. Ross Street, *Trees, permutations and the tangent function*.

45. E. Szemerédi, *On sets of integers containing no k elements in arithmetic progression*, Acta Arith. **27** (1975), 199–245. MR 369312
46. ———, *On sets of integers containing no k elements in arithmetic progression*, Proceedings of the International Congress of Mathematicians (Vancouver, B. C., 1974), Vol. 2, 1975, pp. 503–505. MR 0422191
47. Terence Tao, *The dichotomy between structure and randomness, arithmetic progressions, and the primes*, International Congress of Mathematicians. Vol. I, Eur. Math. Soc., Zürich, 2007, pp. 581–608. MR 2334204
48. Stevo Todorćević, *Introduction to Ramsey Spaces*, Princeton University Press, 2010.
49. Wei Wang, *Some logically weak Ramseyan theorems*, Advances in Mathematics **261** (2014), 1–25.
50. Klaus Weihrauch, *The degrees of discontinuity of some translators between representations of the real numbers*, Technical report TR-92-050, International Computer Science Institute, Berkeley, 1992.
51. Andy Zucker, *Big Ramsey degrees and topological dynamics*, Groups Geom. Dyn. **13** (2019), no. 1, 235–276. MR 3900770

Index

- 2^n , 12
- $2^{<n}$, 12
- $<_{\mathbb{Q}}$, 67
- $[\sigma]$, 12
- $[X]^n$, 23
- ACA_0 , 15
- $\omega^{<\omega}$, 11, 12
- $2^{<\omega}$, 12
- \leq_c , 16
- Δ_2^0 approximation, 78
- ϵ , 12
- E_{pn} , 87
- \equiv_T , 6
- \leq_T , 6
- $|\sigma|$, 12
- $<_{\text{lex}}$, 64
- $A^{|\text{vl}|}$, 112
- (\mathcal{B}) , 23
- $\llbracket \cdot, \cdot \rrbracket$, 65
- ω -model, 16
- ω^n , 12
- $\omega^{<n}$, 12
- \oplus , 11
- $\mathcal{P}(X)$, 11
- Φ_e , 13
- Π_1^0 , 14
- $\Pi_1^{0,X}$, 14
- \prec , 12
- \preceq , 12
- RCA_0 , 15
- $\text{roots}(X)$, 20
- \sqcup , 11
- $\mathcal{S}_n^i()$
 - product, 44
 - tree, 44
- $S_{<\alpha}()$, 21
- $S_{\alpha}()$
 - forest, 21
 - product of trees, 21
 - tree, 19
- \vdash , 43
- $\bar{\vdash}$, 11
- \Vdash
 - product tree condition, 31
 - tree condition, 33
- A^\wedge , 64, 112
- A^{cl} , 112
- $e_{s\text{TT}}$, 113
- k -branching, 18
 - tree, 18
- $\text{leaves}(T)$, 18
- m - π -dense matrix, 21
- m - σ -dense, 21
- $t_{\text{TT}}^T(n)$, 120
- t_{DT} , 63
- $t_{s\text{TT}}$, 114
- age of a structure, 71
- approximation
 - Δ_2^0 , 78
 - Δ_3^0 , 78
- basis theorem, 14
 - cone avoidance, 14
 - low basis, 14
- big Ramsey degree, 25
 - finite, 25
- big Ramsey structure, 26
 - DLO, 67
 - Rado graph, 88
- blossom
 - Joyce graph, 90
 - tree, 90
- bounded
 - tree, 19
- class
 - Π_1^0 , 14
- closure
 - full, 112
 - level, 112

- meet, 112
- coded
 - Joyce graph, 89
 - Joyce order, 69
- coloring
 - level-homogeneous, 58
 - limit, 47
 - stable, 47, 106
- compound tree condition, 34
 - cone avoiding, 34
- computable, 6
 - reducibility, 8, 16
- computable reducibility, 16
- computably bounded
 - tree, 19
- computably enumerable, 13
- computably true, 7
- concatenation, 12
- condition
 - compound tree condition, 34
 - product tree, 30
 - tree, 33
- cone avoidance, 9, **17**
 - basis theorem, 14
 - strong, 9, **17**
- dense
 - m - σ -dense, 21
 - matrix, 21
 - subset, 21
- Devlin's theorem, **23**, 63
- diagonalization
 - Joyce graph, 95
 - Joyce order, 72
- direct extension, 18
 - forest, 20
- DNC
 - degree, 79
 - function, 79
- embedding type, 112
- Erdős Rado theorem, 81
- extension
 - product tree condition, 31
 - proper, 12
 - string, 12
- forcing
 - product tree, 30
 - tree, 33
- forest, 19
 - height, 20
 - root, 20
 - strong subforest, 21
- full closure, 112
- function
 - DNC, 79
 - hyperimmune, 107
 - symmetric, 64
- generalized CHM tree theorem, **25**
 - strong, 111
- graph
 - Joyce, 87
 - Joyce Rado, 87
 - Rado, 23
 - random, *see also* Rado
- Halpern-Laüchli theorem, **22**, 27
 - for $2^{<\omega}$, 6
- halting problem, 6
- height, 18
 - forest, 20
- homogeneous set
 - for a coloring, 4
 - for a tree, 78
- hyperimmune
 - function, 107
 - set, 107
- incompatible
 - string, 12
- index
 - product tree condition, 44
- initial segment
 - proper, 12
 - sequence, 12
 - string, 12
- isomorphism
 - fully closed tree, 112
 - Joyce structure, 67
- Joyce
 - graph, 87
 - order, 65
 - Rado graph, 87
 - structure, 67
 - tree, 64
- Joyce graph, 87
 - blossom, 90
 - coded, 89
 - diagonalization, 95
 - structure, 88
- Joyce order
 - coded, 69
 - diagonalization, 72
- Joyce structure, 67
 - DLO, 67

- isomorphism, 67
- jump
 - ideal, 16
 - Turing, 13
- label
 - Joyce order, 64
 - Joyce tree, 64
- leaf, 18, 20
- level, 18, 20
 - function, 19
- level closure, 112
- level-closed, 111
- level-homogeneous
 - coloring, 58
 - product tree condition, 58
- low
 - basis theorem, 14
- low set, 107
- meet
 - string, 12
- meet closure, 112
- meet-closed, 111
- Milliken's tree theorem, **22**
 - MTT^n , **22**
 - $PMTT^n$, **22**
 - for $2^{<\omega}$, 5
 - product version, **22**
- model
 - ω -model, 16
 - second-order arithmetic, 16
- node, 18
 - k -branching, 18
 - direct extension, 20
 - leaf, 18, 20
 - level, 18, 20
- odd tangent numbers, 63
- order
 - Joyce, 65
- ordered tuples, 11
- ordering
 - $<_Q$, 67
 - $<_{lex}$, 64
- prehomogeneous
 - product tree condition, 43
 - tuple, 43
- principal function, 58
- problem, 7, **16**
- product tree condition, 30
 - computable, 44
 - cone avoiding, 38, 48
 - extension, 31
 - index, 44
 - level homogeneous, 38
 - level-homogeneous, 58
 - prehomogeneous, 43
 - stable, 48
 - strong extension, 38
- proper extension, 12
- proper initial segment, 12
- Rado Graph, 23
 - Joyce, 87
- Rado graph theorem, 24, 87
- Ramsey
 - big degree, 25
 - big structure, 26
- Ramsey's theorem
 - finite, 4
 - infinite, 4
- reverse mathematics, 7
- root
 - forest, 20
 - tree, 17
- set
 - cohesive, 106
 - hyperimmune, 107
 - low, 107
 - thin, 78
- stable
 - coloring, 47
 - product tree condition, 48
- statement
 - $CHMTT_{k,\ell}^n$, 25
 - $DT_{k,\ell}^n$, **23**
 - $JDT_{k,\ell}^n$, 74
 - $JRG_{k,\ell}^n$, 88
 - ER^2 , 81
 - $SCHMTT_{k,1}^n$, 111
 - COH , 106
 - SRT_2^2 , 106
 - MTT^n , **22**
 - $PMTT^n$, **22**
 - $PMTT_{k,\ell}^n$, 62
 - $RG_{k,\ell}^G$, 24
 - $RG_{k,\ell}^n$, 24
 - $RT_{k,\ell}^n$, 58
- string
 - concatenation, 12
 - extension, 12
 - incompatible, 12
 - meet, 12

- strong cone avoidance, 9
- strong subforest, 21
- strong subtree, 19
 - level function, 19
- structure
 - Joyce graph, 88
- subsystem
 - ACA₀, 15
 - RCA₀, 15
- subtree
 - strong, 19
- syntactical minimization, 115

- theorem
 - Chubb, Hirst, McNicholl, *see also*
generalized CHM tree theorem
 - Devlin's theorem, **23**
 - Erdős Rado theorem, 81
 - generalized CHM tree theorem, **25**
 - Halpern-Laüchli theorem, 6, **22**
 - Milliken's tree theorem, 5, **22**
 - Milliken's tree theorem for product,
22
 - Rado graph theorem, 24
- thin set, 78
- total functional, 13
- tree, 17
 - k -branching, 18
 - blossom, 90
 - bounded, 19
 - computably bounded, 19
 - condition, 33
 - height, 18
 - Joyce, 64
 - level, 18
 - node, 18
 - root, 17
 - strong isomorphism, 112
 - strong subtree, 19
- tree condition, 33
- tree theorem
 - generalized CHM tree theorem, **25**
 - Halpern-Laüchli theorem, **22**
 - Milliken's tree theorem, 5, **22**
 - Milliken's tree theorem for product,
22
 - strong generalized CHM tree
theorem, 111
- tuple type, 114
 - length-injective, 118
 - meet-avoiding, 118
- Turing
 - equivalence, 6
 - functional, 13
 - ideal, 16
 - jump, 13
 - reduction, 6
- type
 - embedding, 112
 - tuple, 114
 - weak tuple, 117
- weak tuple type, 117